

## Accepted manuscript

Noorsumar, G., Robbersmyr, K. G., Rogovchenko, S. & Vysochinskiy, D. (2020). Crash Response of a Repaired Vehicle - Influence of Welding UHSS Members. SAE technical paper series, 169-195. <https://doi.org/10.4271/2020-01-0197>

Published in: SAE International

DOI: <https://doi.org/10.4271/2020-01-0197>

AURA: <https://hdl.handle.net/11250/3090489>

Copyright:

# Crash Response of a Repaired Vehicle - Influence of Welding UHSS Members

Gulshan Noorsumar, Kjell G. Robbersmyr, Svitlana Rogovchenko and

Dmitry Vysochinskiy.

Department of Engineering Sciences

University of Agder

4879 Grimstad, Norway

*Abstract* Automakers generally recommend not to weld structural parts after a vehicle crash, and these should be replaced as a whole part in case of a crash event. Sectioning of these members is also not recommended, and use of the repair manual is mandatory in case of fracture of such parts. However, repair shops may not adhere to these instructions and use incorrect repair procedures on these members which would modify their strength properties. This study analyses the impact of welding structural members in a vehicle like the A-pillar which use Ultra-High Strength Steels (UHSS) for reducing the weight of the vehicle and improving the crashworthiness of the structure. The research conducted in this paper highlights the differences in the crash performance of a repaired vehicle as opposed to baseline injury values for the vehicle. The performance of the modified vehicle when tested for different loadcases shows reduced crash performance as compared to the baseline performance and it can be concluded that welding or sectioning the UHSS parts would influence the crashworthiness of a vehicle. This paper only focuses on structural integrity of the repaired vehicle in a crash event. The performance of the vehicle in occupant injury is kept out of scope for this study.

## E.1 Introduction

The word ‘crashworthiness’, first used in the aerospace industry around the early 1950’s provided a measure of the ability of the structure to protect its occupants in survivable crashes [1]. In the automotive industry the term refers to the measure of vehicle’s structural abilities to plastically deform and absorb sudden impact loads while maintaining enough survival space for the occupants. The goal of crashworthiness: Vehicle structures should be stiff in bending and torsion for proper ride and handling. The vehicle structures should minimize fore-aft vibrations that give rise to harshness. The vehicle structure should [1]:

- Deform plastically in the vehicle front end and absorb crash energy in case of a frontal crash and prevent intrusions in the driver compartment
- Deformable rear structure to protect rear occupants in case of a rear impact and well-designed side structures to prevent intrusion into passenger compartment and preventing opening of doors due to loading in a crash

In October 2015, the European Commission launched a study to analyse crashes in order to identify a number of most common crash scenarios with serious injuries as an outcome. In all datasets frontal impacts are most common followed by side-impacts in crashes where car occupants get severely injured. This might be related to the differences in impact and the force at which the cage of the car protects the occupant when hit from different sides as well as a reflection of the probability that a car is hit on a particular side [2]. Some of the recommendations provided by the report suggest further study of mechanisms and effective measures directed at severe injuries in road accidents. EuroNCAP is one of the global New Car Assessment Programme (NCAP) that has been influential in bringing about improvements in vehicle safety. However, it's commonly referred to as 'consumer metric' because it is not based on government regulations/legislations. Car makers across the globe treat this as a common metric to determine the crashworthiness of their products and achieve a target star rating [3]. These regulations and consumer ratings have led automakers to use innovative technologies in the form of active and passive safety to meet the performance requirements [4]. One of the conventional design solutions used by automakers to meet front end crash requirements is to increase the gauge of the structural load bearing members. This leads to increased durability of the members and improved occupant protection. However, upsizing the thickness led to mass increase and reduced fuel economy. According to the research in [3] the automobile weight loss is 10%, the consumption of fuel reduced by 8% and the emissions reduced by 4%. This propelled the need for automakers to optimize the vehicle mass while meeting the crash requirements leading to use of Advanced High Strength Steel (AHSS) in structural members of the vehicle. Steels with yield strength levels in excess of 550MPa are generally referred to as AHSS. These are also sometimes called Ultra-High Strength Steels (UHSS) for tensile strengths exceeding 780 MPa [5]. The research conducted in [4] emphasized the influence of AHSS parts in crash behavior and concluded that using these steel grades improves the crashworthiness of the vehicle. The study in [6] introduced AHSS to auto-roof strength application and studied by FEA simulation to demonstrate that AHSS design can meet the proposed more stringent roof crush requirement. The excellent properties of steel are achieved by employing common alloying elements (carbon, manganese, boron, silicon, nickel, chromium and molybdenum) and other metallurgical strengthening mechanisms

which help in its excellent tensile strength [7]. However, these strength properties come with difficulties associated with the welding and joining processes for these materials which can affect its properties. The research paper [7] lists down the difficulties encountered during welding and Heat Affected Zone (HAZ) softening of UHSS and the possible impact of these processes on the material behavior [7].

Collision repair of vehicle is a process which is outlined by an automaker for every product in its portfolio and it includes the procedure to repair/replace a part in the vehicle. The repair manual is a detailed document which explains the process for every part in the vehicle based on its structural properties, influence of heat treatment and crashworthiness abilities. The manual also lists down the circuits diagrams for electrical components to help the technicians who have the specific tools/facilities to repair cars. Most automakers suggest replacement of structural components after plastic deformation and prohibit heat repair for body and frame parts. The parts using UHSS are recommended not to undergo reinforcement repair to ensure the crashworthiness of the vehicle and occupant protection features are not modified. This is crucial to the safety of occupants because in the event of a crash of the repaired car the structural integrity of the vehicle should prevent occupant compartment intrusions.

However, it has been observed in certain cases that the repair shops/technicians may not follow the procedures outlined by the automakers which could lead to safety issues for the occupants of the vehicle in a crash. Unprofessional repairs could result due to the following reasons: [8]

- Repair of parts when replacement is necessary or recommended
- Insufficient knowledge of repairing the parts leading to wrong assembly or processes
- Incorrect process to repair the parts
- Absence of special tools
- Use of poor/low quality spares and components
- Incorrect connections and wiring of electrical harnesses or subsystems

The recommended procedures for UHSS parts are replacement of the complete part and following the repair manual from the Original Equipment Manufacturer (OEM) strictly. This would prevent compromising the structural integrity of the vehicle and occupants in a crash. Recent trends involve car manufacturers resort to Computer Aided Engineering (CAE) using an FE (finite element) model of the vehicle which represents the geometry of the vehicle and includes material non-linearities. These models help to test the vehicle for different crash scenarios instead

of conducting a physical test. These FE models aid in the vehicle development cycle and are updated during different stages of vehicle development. Automakers also put huge focus on CAE modeling strategies to accurately represent different parts of the vehicle and their interactions. There are commercially available solvers like LS Dyna and PamCrash which help predict the crash scenario in vehicle FE models. These solvers can support complex geometries and fine mesh sizes to accurately predict injury values. This has led to the automotive CAE engineers use complex models with mesh refinement to capture the geometry and material characteristics. The result is accurate representation of crash mechanics at the expense of huge computational times and high solver capacities required to run these simulations.

Several attempts have been made to reduce computational time of full vehicle models by using simplified structural modeling. The simplified model developed by Michael et. al. [9] is validated against a full-frontal barrier model and shows encouraging results. The use of beam grid model is a growing trend in CAE to represent a vehicle crash model. Reducing run time of an FE model using beam grid approach was attempted and shows considerable reduction in computational time [10].

Crash performance of vehicle structures in different impact scenarios was studied in detail in [11]. The paper focusses on developing a simplified crash model for analysis and then validating the simulation results with physical test data. Several similar studies have been conducted to compare the FE models with physical test data to gain confidence on using LS Dyna simulations to predict crash injury values. In this study we attempt to examine the impact of unprofessional repairs on a vehicle which uses UHSS and conduct crash test simulations on the vehicle after a repair which does not follow standard repair procedures. This paper addresses different scenarios of improper repairs and the possible consequences after an impact. The crash tests simulations are performed on a Finite Element (FE) model using LS Dyna non-linear analysis solver. The study also compares the iteration results with Finite Element simulations performed using the baseline FE model.

This study was conducted on the 2011 Honda Accord (Sedan) vehicle. These models were selected because they use UHSS for the load bearing members. The finite element models were developed by National Highway Traffic Safety Administration (NHTSA) along with National Crash Analysis Center (NCAC) [12]. It is to be noted that this study uses the FE models from the NHTSA database but it does not try to replicate the light weight study or change the content of the report published by the team at NHTSA.

## E.2 FE Model Description

The Honda Accord Model (2011), a 4 door mid-size sedan was developed by a research team led by NHTSA to represent this vehicle with a detailed finite element model and used to replicate multiple impact scenarios. The research project modified the vehicle to a light-weight version using UHSS having high yield strength (1250-1500 MPa) and improve performance for crash regulations [13]. The study conducted for this paper uses the modified vehicle as a baseline model and modifications are made on the vehicle to replicate unprofessional repair procedures. The study also employs different Computer Aided Engineering (CAE) methodologies to represent repair strategies and observe the changes in the results. The FE model was run for baseline impact with the following front and side impact regulations.

- IIHS Small-Overlap Frontal Barrier Test
- NCAP Front Impact Test
- IIHS Moderate Frontal Offset Test
- IIHS Lateral Moving Deformable Barrier Test
- NCAP Side Impact Test
- Lateral NCAP Pole Side

The modifications made to the baseline vehicle were updated to all the models and run for evaluating all the loadcases and observe the differences in the performance in comparison to the base vehicle.

## E.3 Loadcase Requirements

The instrumentation needed for these tests measures the severity of impact on the structural integrity and occupant dummies used for the test. Occupant protection has been kept out of scope for this study.

### E.3.1 IIHS Small-Overlap Frontal Barrier Test (IIHS SOL)

This test is conducted at 40 mph vehicle speed when the vehicle hits a 5-foot tall rigid barrier. This test tries to replicate a scenario of a vehicle hitting another vehicle, an object or a utility pole. The test conducted on the driver side strikes the barrier at 25% width of the vehicle from the vehicle centerline.

The regulation rates the vehicle on the basis of structural integrity of the vehicle at 7 points of the vehicle interior plus, movement of three points along the door

frame. This is a total of 18 points on the vehicle [14]. The 18 points are distributed as follows: Steering Column (1), Left Instrument Panel (1), Brake Pedal (1), Parking Brake Pedal(1), Footrest (1), Seat Bolts(2), Left Toepan (1), Upper Dash (1), Lower (three points) and upper (three points) hinge pillar, Rocker panel (three points),

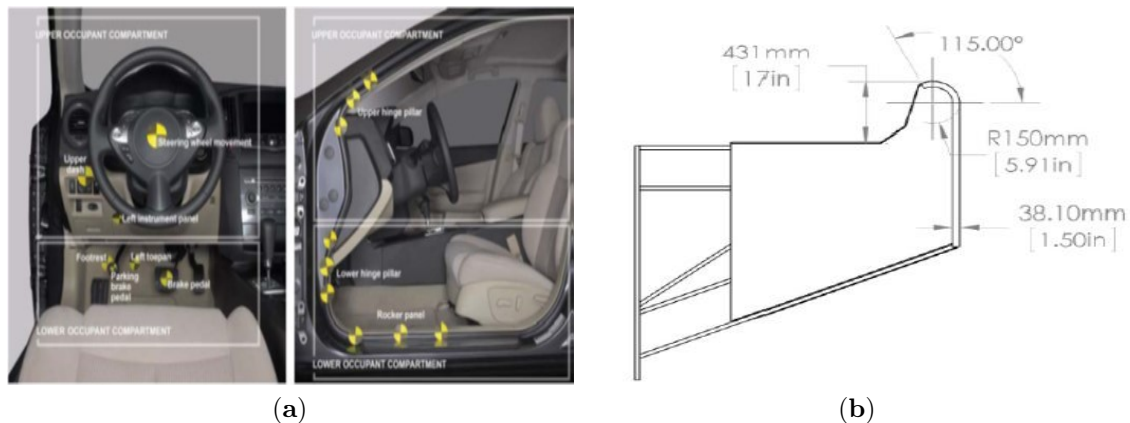

Figure E.1: (a) Locations used for measuring vehicle intrusion, (b) SOL Barrier, Top and Isometric Views

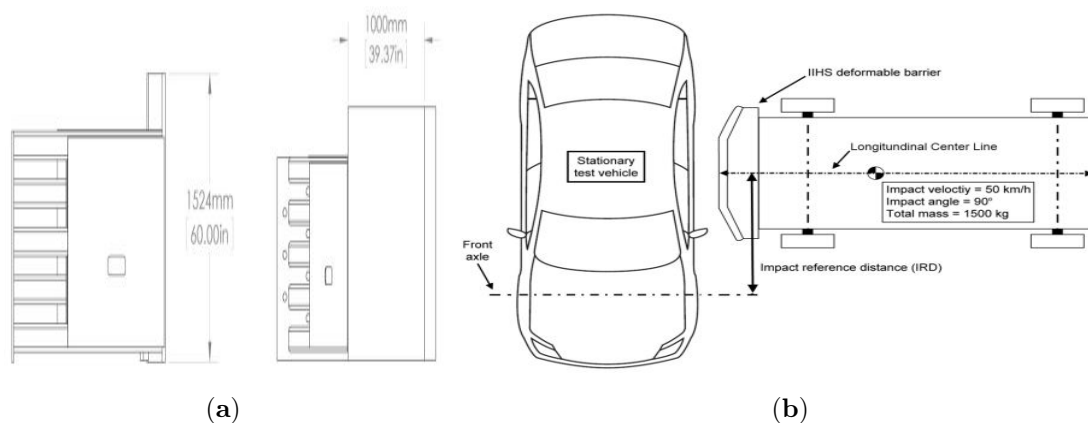

Figure E.2: (a) SOL Barrier, Side and Front Views, (b) IIHS Lateral Moving Deformable Barrier aligned with the test vehicle [

The points of measurement on the vehicle lower occupant compartment and upper occupant compartment are shown in Figure E.1(a) below [14]. Figure E.1(b) and E.2(a) indicate the SOL barrier top, isometric, side and front views.

### E.3.2 NCAP Front Impact Test

This is a full-width impact on the vehicle front. This test is run with a rigid barrier and the vehicle meeting a head-on collision at 56 kmph. The NCAP test for full frontal impact has shorter pulse time width and lower occupant compartment intrusion [13].

### **E.3.3 IIHS Moderate Frontal Offset Test**

This test, as the name suggests, is a frontal offset crash test with the vehicle hitting a 40% overlap barrier. The vehicle speed is 64 kmph and the intrusions on the driver side are measured at 14 locations on the interior and exterior of the vehicle. The coordinates of these 14 locations before and after the crash are recorded and compared to understand the intrusion in the driver compartment. The barrier has a rigid base unit, an extension and a deformable face. The barrier specification has been outlined in the IIHS protocol.

### **E.3.4 IIHS Lateral Moving Deformable Barrier Test**

This test includes a 1500 kg moving deformable barrier hitting a stationary vehicle at a speed of 50 kmph. The barrier strikes the vehicle at 90 degrees angle to the driver side and the longitudinal impact point of the barrier on the side of the test vehicle is dependent on the wheelbase. The impact reference distance is defined as the distance rearward from the test vehicle's front axle to the closest edge of the deformable barrier when it first contacts the vehicle. The standard barrier is a trolley vehicle with a deformable front end. The intrusion measured on the vehicle at different ground heights at the vehicle B-pillar helps document the IIHS safety rating. Figure E.2(b) shows the IIHS Lateral Moving Deformable Barrier loadcase setup.

### **E.3.5 NCAP Side Impact Test**

The Lateral NCAP moving deformable barrier test is a side impact test with a moving deformable barrier, weighing 1368 kgs and it strikes a stationary vehicle (positioned at an angle of 63 degrees to the line of forward motion). The barrier moves with a speed of 62kmph. Figure E.3 shows the orientation of the trolley for NCAP side test.



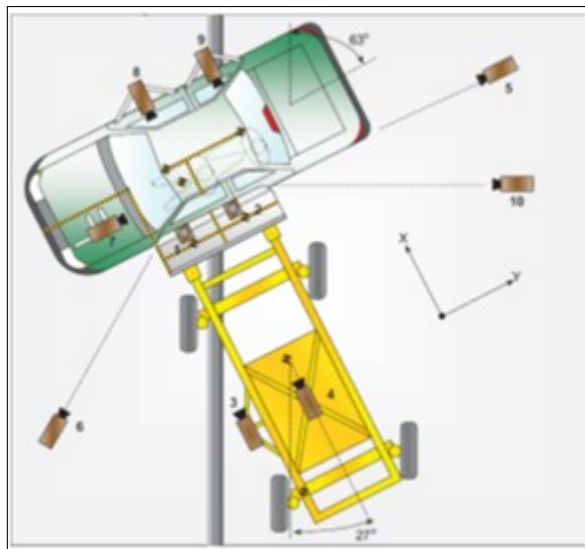

Figure E.3: Orientation of trolley to struck vehicle in NCAP side impact test with moving deformable barrier

### E.3.6 IIHS Moderate Frontal Offset Test

This test, as the name suggests, is a frontal offset crash test with the vehicle hitting a 40% overlap barrier. The vehicle speed is 64 kmph and the intrusions on the driver side are measured at 14 locations on the interior and exterior of the vehicle. The coordinates of these 14 locations before and after the crash are recorded and compared to understand the intrusion in the driver compartment. The barrier has a rigid base unit, an extension and a deformable face. The barrier specification has been outlined in the IIHS protocol.

## E.4 CAE Methodology

The study includes setting up finite element crash tests for the loadcases and using LS Dyna solver to simulate the impacts. The FE model chosen for this study uses UHSS on the A-pillar reinforcements and some rocker reinforcements. The baseline model was run with the crash loadcases and the results compared to data furnished in the report from NHTSA in [13]. The baseline model meets all safety loadcase requirements with a good margin and was a good candidate to investigate if the performance deteriorated with inclusion of incorrect repairing strategies. A preliminary study was conducted on the FE model with removing few rows of elements from the A-Pillar part to investigate its influence on the crash regulations. (Figure E.4) This modified vehicle representing cracks on a vehicle A-Pillar was simulated with the crash loadcases and the results were compared with baseline performance of the vehicle. The IIHS SOL loadcase showed considerable performance deterioration

over the base model. This modification emphasized the need to investigate more on the A-Pillar contribution on the load distribution in a crash event. Figure E.5 shows A-Pillar failure in the modified model. The baseline model in yellow and the modified (iteration) in blue show comparisons between the two animations.

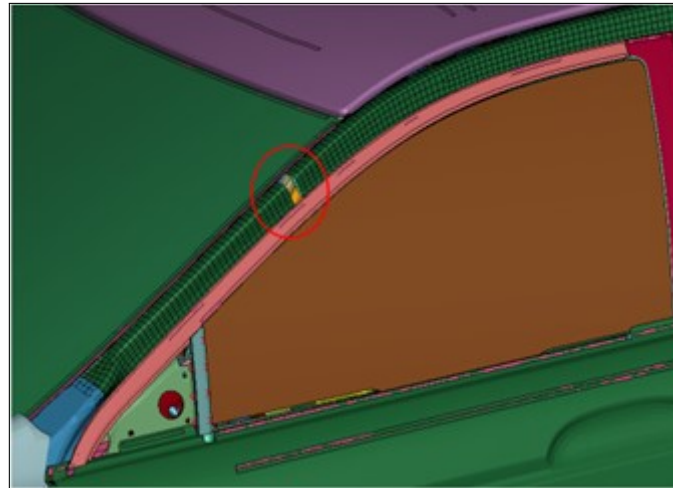

Figure E.4: Encircled zones show A-Pillar failure in the modified model (in blue) and absence of buckling in the baseline model (in yellow).

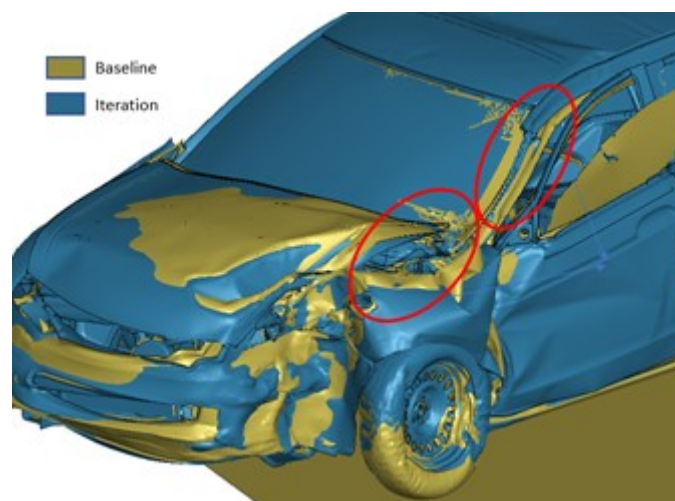

Figure E.5: Encircled zone shows A-Pillar elements removed for the preliminary study.

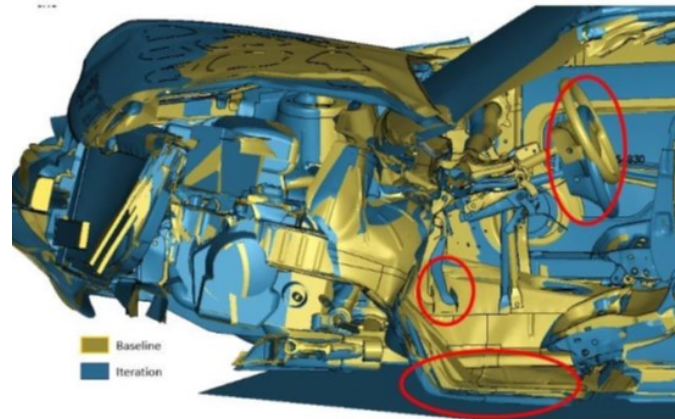

Figure E.6: Vehicle cut section showing higher intrusion in the vehicle compartment.

The modified model is observed to have more deformation in the A-Pillar and door structural members (Figure E.5). This indicated that the load distribution of a crash model is changed by a small fracture in the UHSS part. The buckling in the A-pillar shows reduced structural performance in the iteration model. Figure E.6 shows higher intrusion in the driver compartment, steering wheel axial and lateral movement and brake pedal movement in the occupant zone.

#### E.4.1 Representation of Welding of UHSS:

One of the incorrect repair procedures is welding the UHSS steel members which considerably reduces its yield strength and causes it to yield much before the expected time. The baseline FE model was modified to include butt welds in the A-Pillar to represent the Heat Affected Zone (HAZ). Different CAE strategies were employed to represent the weak zone in the structural steel part. It is to be noted that only UHSS parts on the A-Pillar were modified for the study, the parts with mild steel were not modified on the A-Pillar.

- Representing a small zone on the UHSS member with a part having low yield strength material
- Using beam elements to represent the weld material in the part
- Incorporating beams in the weld zone and surrounding elements being assigned with low yield strength dyna material model to represent the HAZ.

These strategies were simulated to understand the crash event kinematics.

The strategy (a) showed buckling in the A-Pillar and could be used for the study but the challenge was to determine the yield strength of the heat affected zone after welding the part. This could be investigated with tensile tests conducted on the welded specimen, but it was omitted in this study.

The strategy (c) above provided unrealistic results and was discarded for this study.

The strategy to use welding beams (b) was used for this study and compared against all crash loadcases of the baseline model. The weld material assigned to the parts was dyna material card used for other welds in the finite element model. The beam elements are connected to the A-Pillar with nodes shared to the shell elements in the A-Pillar. This represents a butt weld which connects two pieces of metal. The figure E.7 below shows the material data for beams representing the weld.

**MAT SPOTWELD CARD FROM LS DYNA (SI Units)**

Mass Density	Young's Modulus	Poisson's Ratio	Yield Stress	Plastic Hardening Modulus
1.8 E-9	20000	0.3	120	2000

Effective Plastic Strain in weld material at failure	Axial Force Resultant at Failure	Force Resultant at Failure
1.5	60000	30000

Figure E.7: LS Dyna Weld Material Data for Beam Elements used in the model.

## E.5 Results of crash loadcase comparison with welded beams.

### E.5.1 IIHS Small-Overlap Frontal Barrier Test (IIHS SOL)

The IIHS SOL test was run with baseline model and butt welds added to the vehicle A-Pillar. The CAE model represents a butt weld and the acceleration at the vehicle CG and at points on the A-Pillar show differences in baseline performance. The A-Pillar in the baseline does not show buckling, however the welded model buckles and shows higher intrusion in the driver compartment (Figure E.8 and E.9) This is an alarming observation because the A-Pillar is a structural member which distributes the load during the impact and failure of this part also leads to cracking of the windshield. Another important observation in this iterative model is that the A-Pillar buckles at a point away from the weld and closer to the hood edge. This failure was not observed on the baseline model. The windshield impact could lead to change in airbag timing [7]. This is, however not investigated as part of this study. The intrusion numbers for IIHS swings to the acceptable zone from the 'Good' zone for the

vehicle. It is to be noted that the IIHS SOL baseline performance for this model was comfortably within the targets, however, welding a model with marginal performance could possibly lead to shifting the performance to the ‘Poor’ zone. (Figure E.9). The dashed lines in the figure represent the performance metrics for IIHS SOL test as laid down by the crash regulatory agency (IIHS) for this loadcase.

Another important observation for this model is the structure of the driver side door looks compromised and may not open properly post-crash for occupant ejection. Figure E.11 shows the door deformation compared to the baseline model and it shows higher deformation. It is important the door stays closed during a crash to avoid occupants being thrown out of the vehicle and assists in airbag deployment. The acceleration measured in the A-Pillar region is shown in Figure E.12 below. The acceleration curves show changes in load distribution in the vehicle structural members. The unexpected peaks in the acceleration curve for the modified vehicle explains the energy being distributed to the driver compartment which is not the intended path for a crash event. The acceleration pulses at the vehicle CG shows similar magnitude and duration for the two models (Figure E.13)

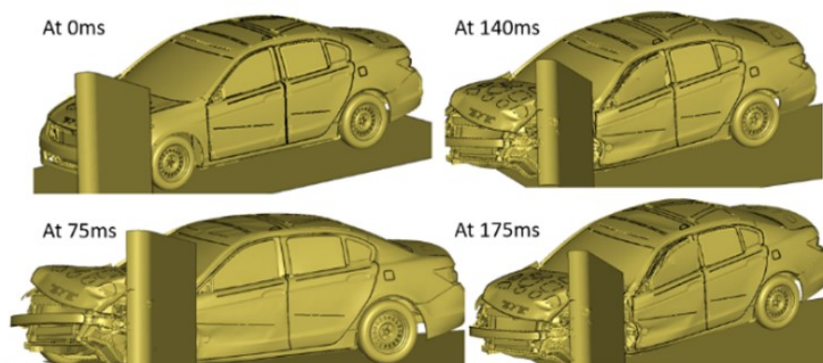

Figure E.8: Baseline performance of Honda Accord for IIHS Small Overlap Test.

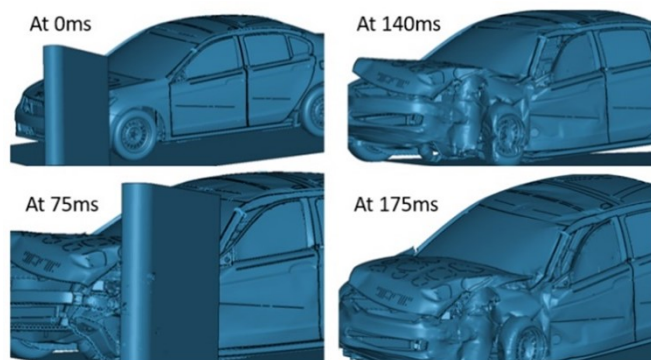

Figure E.9: Modified model Honda Accord with IIHS Small Overlap.

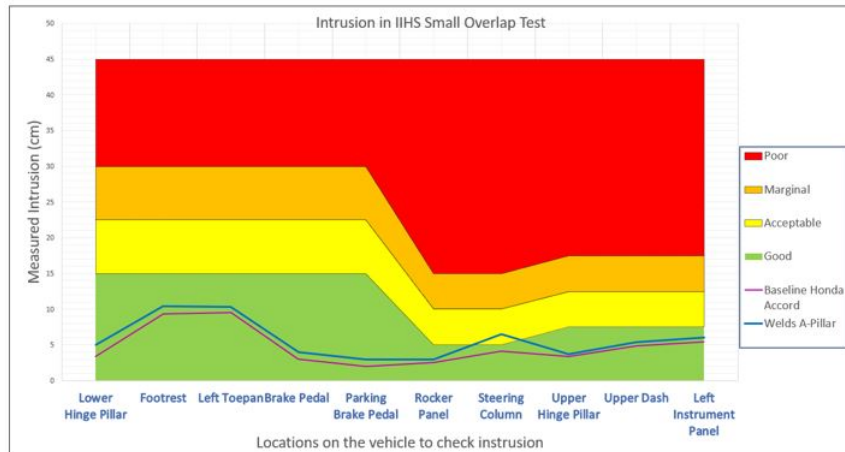

Figure E.10: Measured Intrusion against different positions in the driver compartment for baseline and modified vehicle.

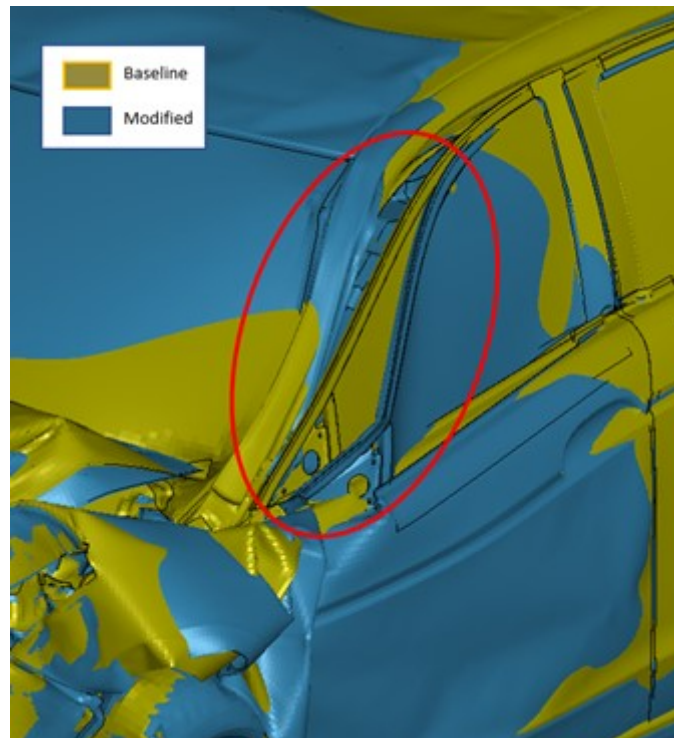

Figure E.11: Vehicle structural changes in the driver compartment for baseline and modified vehicle.

### E.5.2 NCAP Front Impact

The front impact test conducted on the baseline and iteration model yields similar performance indicating nominal impact on the performance of the model with welds. One of the reasons for this reduced impact is enough crush space on the baseline vehicle which does not allow the forces to reach the A-Pillar. The acceleration pulses as shown in Figure E.14 and E.15 on the passenger and driver side of the vehicle

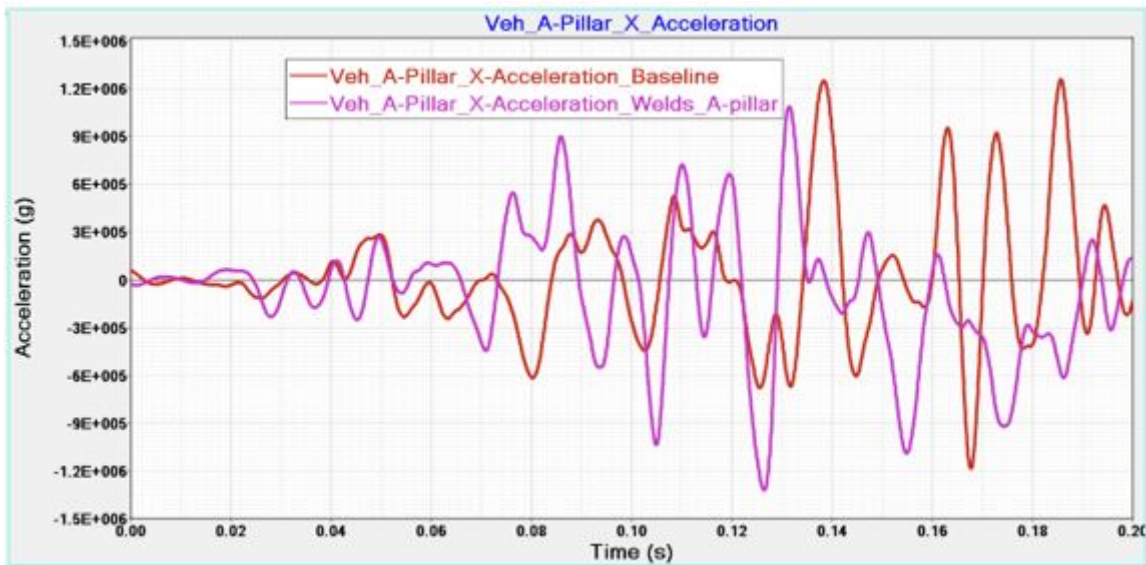

Figure E.12: Vehicle A-Pillar *X*-Acceleration for baseline and welded A-Pillar model

show similar magnitude and duration. The acceleration on the vehicle CG is also comparable to the baseline (Figure E.16) and simulation animation reveals similar crash kinematics. This indicates that the intrusion in the occupant compartment is minimal and the vehicle performs as intended after a repair on the A-Pillar. The position of this weld might affect the performance and can be investigated for research purposes.

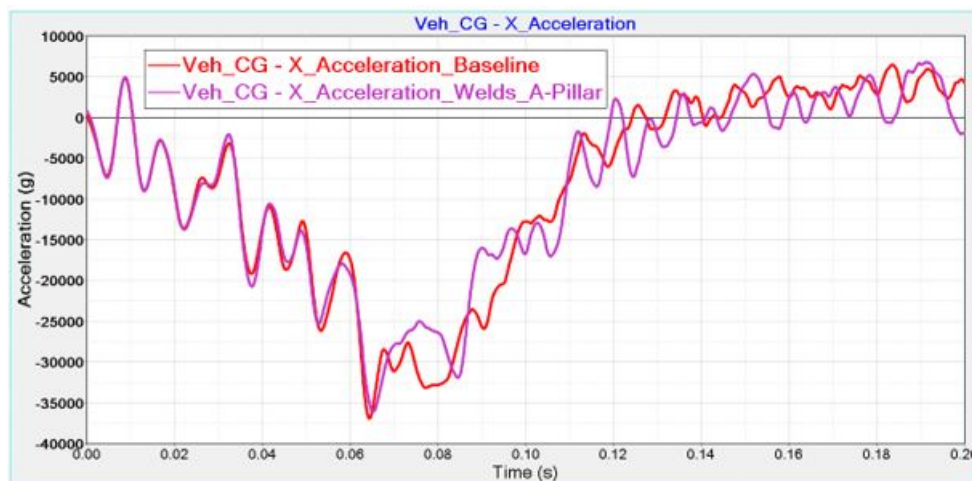

Figure E.13: *X*-Acceleration at vehicle CG.

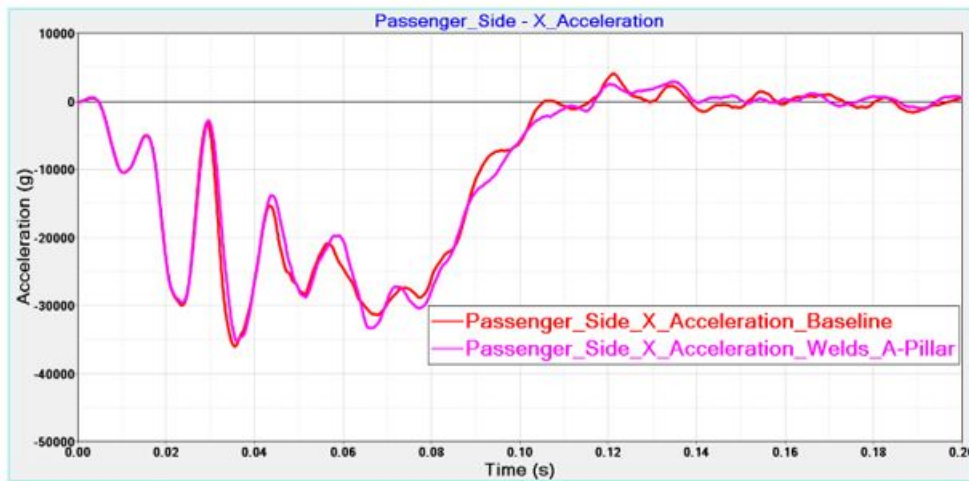

Figure E.14: Passenger side x-Acceleration for NCAP Front Impact

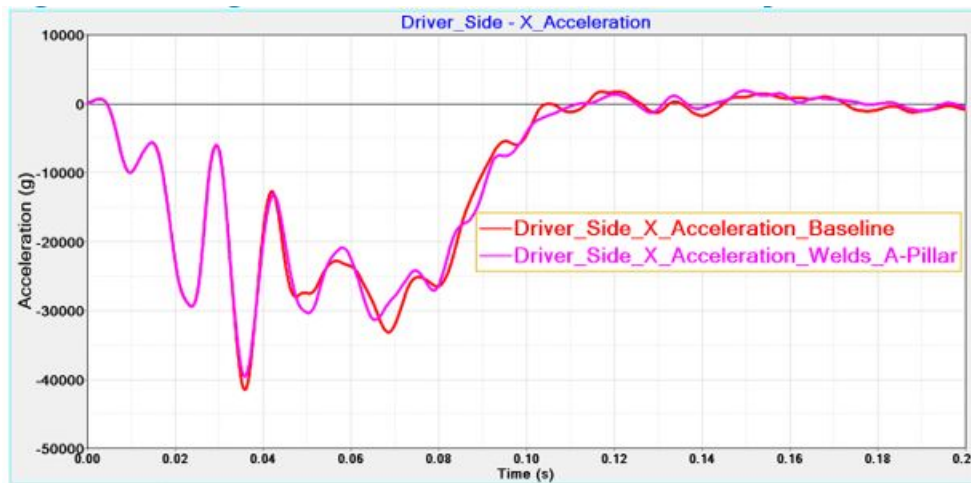

Figure E.15: Driver side X-Acceleration for NCAP Front Impact

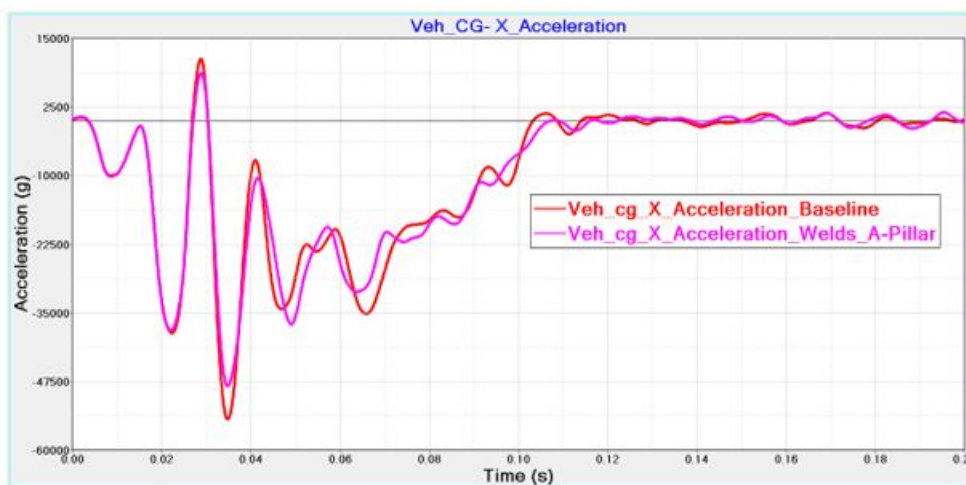

Figure E.16: Vehicle CG X-Acceleration



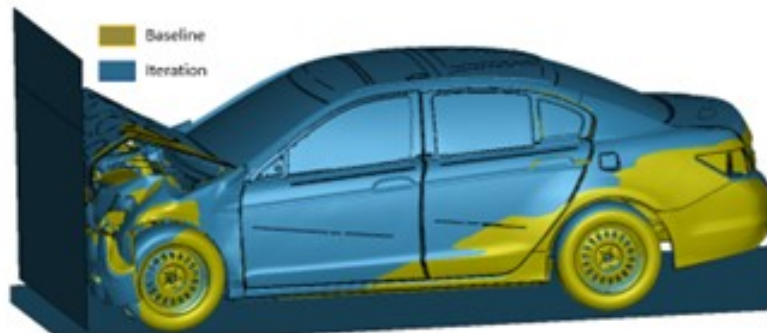

Figure E.17: Isometric view of front impact test with baseline and modified vehicle

### E.5.3 IIHS Moderate Frontal Offset Test

The modified car was also run with the Moderate Frontal Offset test and it shows small variation with the addition of welds. The baseline intrusion profile for this vehicle was comfortably meeting the IIHS performance and falls under ‘Good’ rating. The iteration results show higher intrusion numbers for the model, but the rating does not change and hence this loadcase was not investigated in detail for the changes on the vehicle. Figure E.19 and E.20 show the acceleration response measured on the CG and A-Pillar.

Figure E.21 above indicates the x-displacement in the baseline and iteration model for a front impact model. The intrusions in the occupant compartment are more than the baseline model, it can be concluded that the loads from the crash have been transferred to the occupant compartment which is not safe for the occupants. The areas around the dash and steering column show higher intrusions when compared to the factory model.

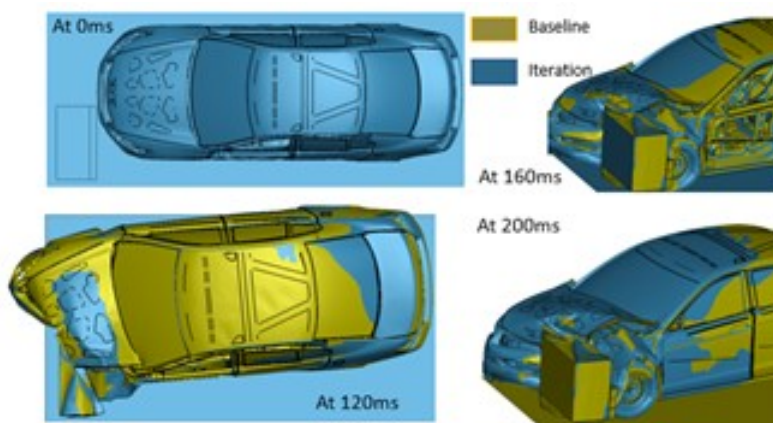

Figure E.18: Moderate Frontal Offset Test for baseline and modified vehicle showing intrusion in the driver compartment

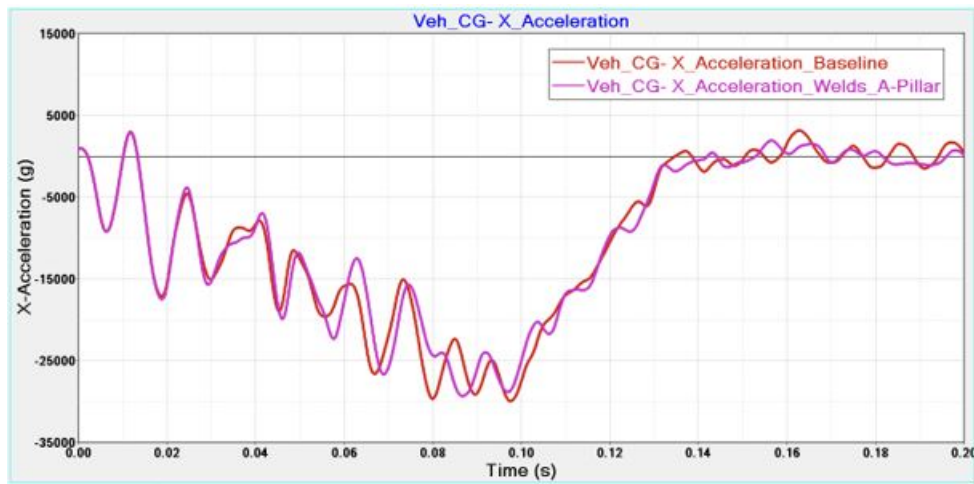

Figure E.19: Vehicle CG X-Acceleration

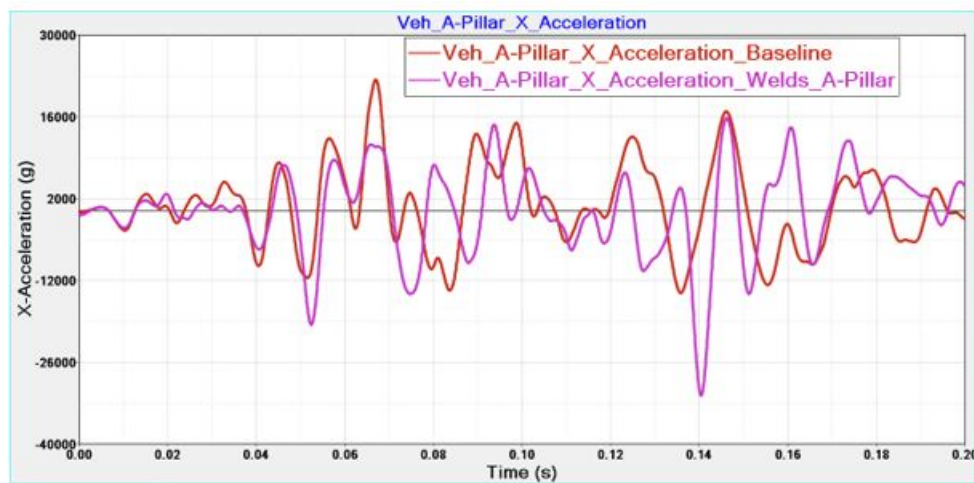

Figure E.20: X-Acceleration plot at A-Pillar

### E.5.4 IIHS Lateral Moving Deformable Barrier Test (IIHS Side Impact)

The baseline and iteration model were tested for the IIHS Lateral Moving Deformable Barrier test and the side intrusions observed for the B-Pillar. The baseline performance of this model was ‘Good’, and addition of welds leads to a shift of the performance to ‘Acceptable’ and closer to the ‘Marginal’ zone for this loadcase (Figure E.22). Figure E.24 shows the iteration model in cut section showing higher intrusion in the occupant compartment. The load distribution in the vehicle is also affected by this small change thus emphasizing the OEM recommendation of not welding the UHSS members to ensure same performance. The X-Acceleration at the vehicle CG does not show too many changes however it would be interesting to

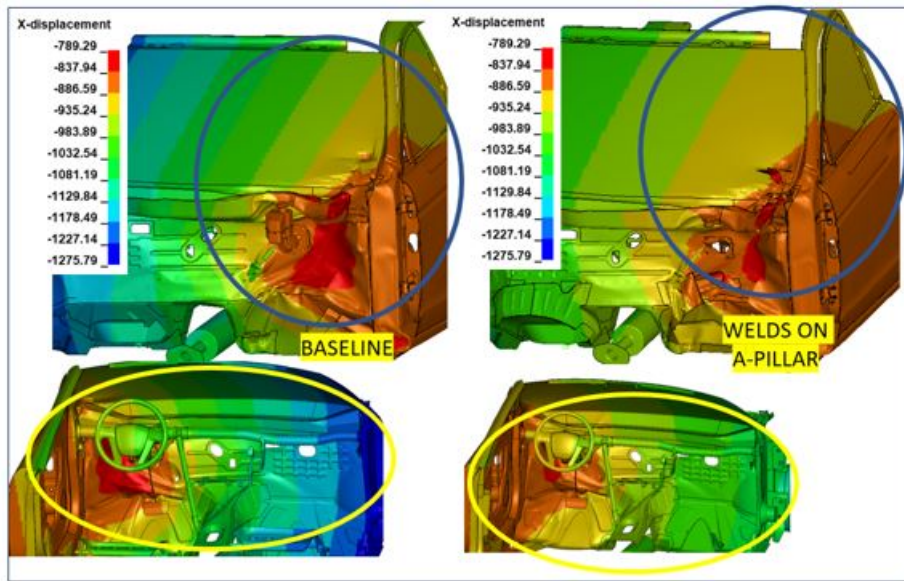

Figure E.21: X-displacement intrusion in the vehicle compartment for baseline and iteration case.

observe if there are multiple welds on the vehicle and how the performance would be affected by this change. It would be interesting to understand how the position of these welds would affect the results.

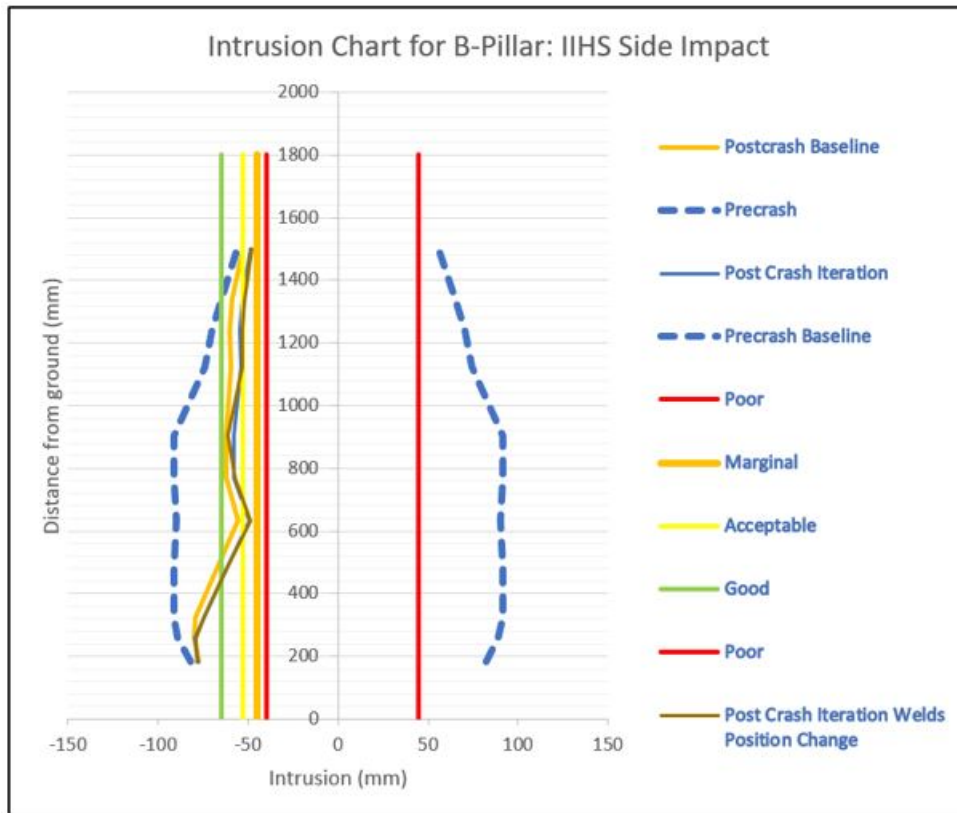

Figure E.22: IIHS Intrusion Chart for B-Pillar Side Impact Intrusions; Baseline and Modified Model compared

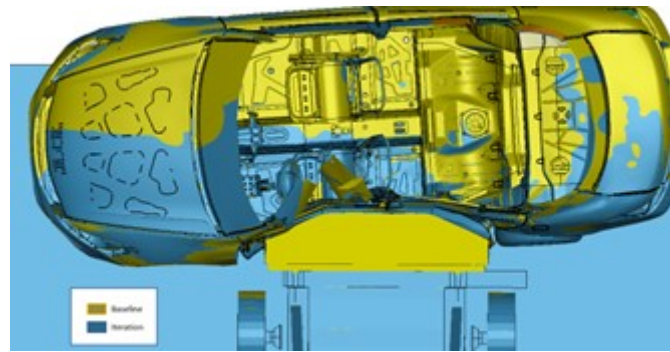

Figure E.23: Side Intrusion comparison for Baseline and Modified Model: Iteration model showing higher intrusion

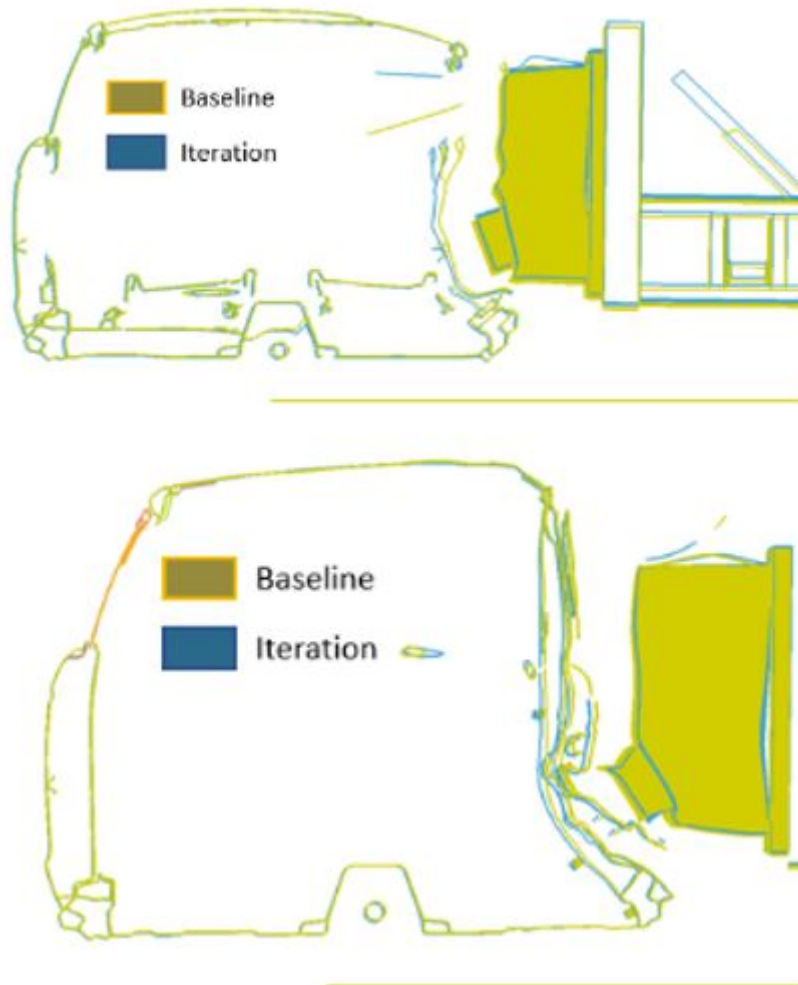

Figure E.24: Cut section views of IIHS Impact Barrier Test at the B-Pillar

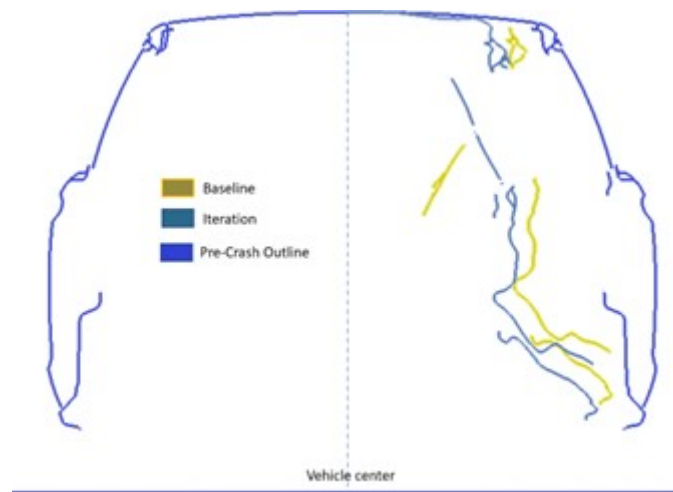

Figure E.25: Comparison of maximum intrusion on the B-Pillar for baseline and modified FE model

### E.5.5 NCAP Side Impact Test (Lateral Moving Deformable Barrier Test)

This test was performed on the modified vehicle and shows improved intrusion values as compared to the baseline results. This observation can be attributed to the low height of this barrier compared to the IIHS side impact barrier. The weld in the A-Pillar allows the barrier load to be distributed to the vehicle body and reduced intrusion in the driver compartment. This explanation could be investigated in more details; however, it has been kept out of scope for this study.

### E.5.6 Lateral NCAP Pole Impact

The NCAP Pole test was performed on the modified models and compared with the baseline performance. The B-Pillar velocity for the modified model shows small changes compared to the baseline but it does not change the performance of the vehicle for this loadcase. (Figure E.27) The X-acceleration measured at the CG and A-Pillar show the load path variations in the model due to the weld but the performance variation is small due to the area of impact of the pole being closer to the B-Pillar, a change in the rocker or B-Pillar region would show greater influence for this loadcase. Figure E.28 shows the simulation comparison for both cases at 180ms.

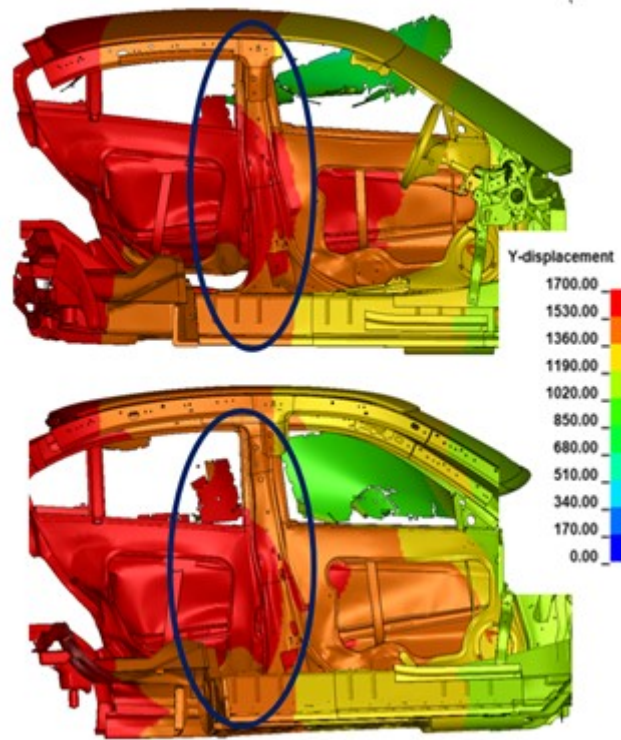

Figure E.26: Y-Displacement on the driver side during NCAP Side Impact test

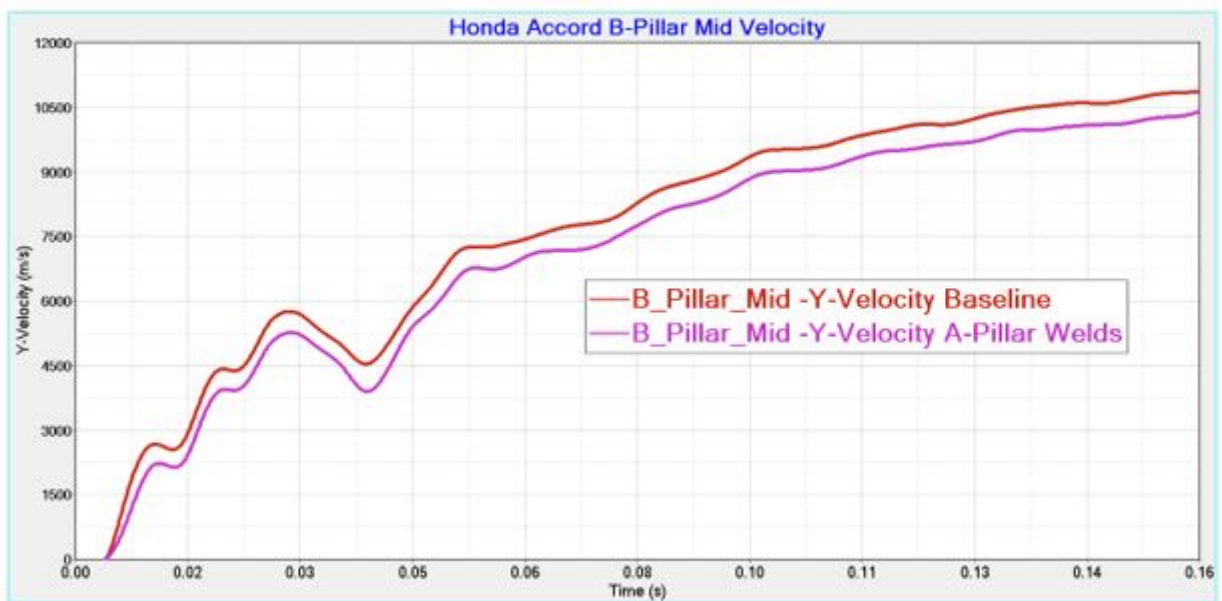

Figure E.27: B-Pillar (Mid) Velocity plot

### E.5.7 Weld Position Analysis

It was observed that the A-Pillar buckled at a few points during IIHS SOL impact, these points were far from the position of the welds. This observation brought out the need to understand the influence of the position of these welds on the A-Pillar or

any structural member. The same Honda Accord model was chosen for this analysis and welds were assigned to 3 different points on the A-Pillar to understand the influence of these welds on the performance of the vehicle for IIHS SOL test. This test was chosen to perform the weld position analysis because it is most sensitive to changes on the A-Pillar (as observed during this study). Figure E.29 shows the 3 positions of welds on the A-Pillar (marked as Iteration 1,2 and 3).

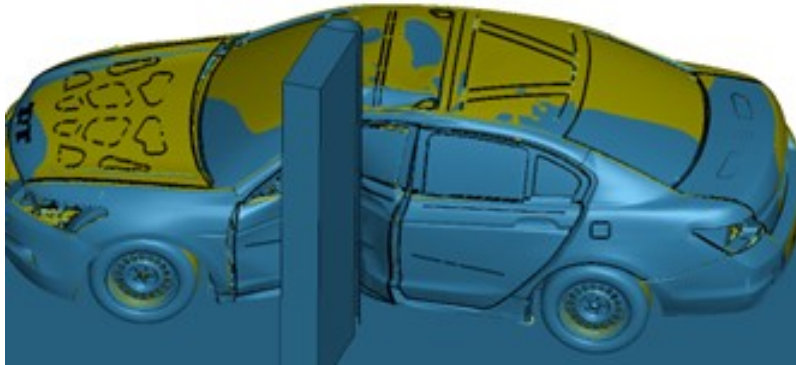

Figure E.28: Lateral NCAP Pole Test at time 180ms

### E.5.8 Weld Position Analysis

The corresponding X-Acceleration for a point on the A-Pillar shown in Figure E.30 below shows that Iteration 3 has the maximum influence on the performance when compared to the baseline. It is also interesting that different positions of welding render a relatively different response in terms of acceleration pulse for the vehicle. This study does not investigate the worst position of welding on the member because every case yields an acceleration higher than the baseline values indicating the fact that welding on the member would create a new unintended load path for the impact. Figure E.31 shows higher X-intrusion in the iteration models as compared to the baseline plots. One of the possible reasons Iteration 3 has the maximum influence on the crash performance is its position in the middle of the A-Pillar and the buckling of the A-Pillar leads to maximum deformation and intrusion in the driver compartments

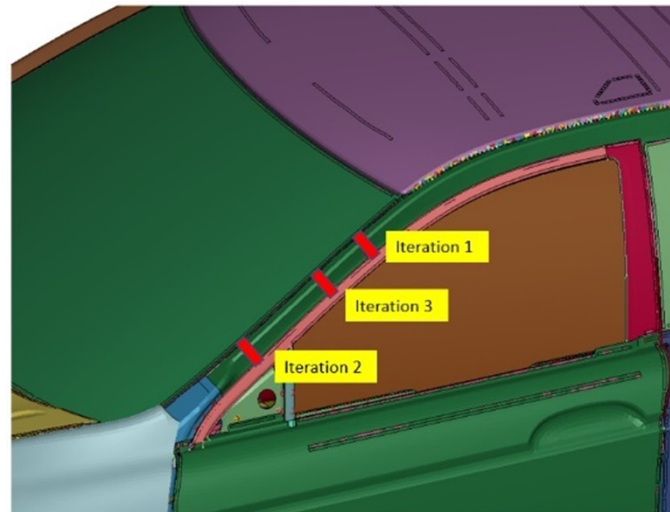

Figure E.29: Position of welds on the A-Pillar for analyzing influence of position on the performance

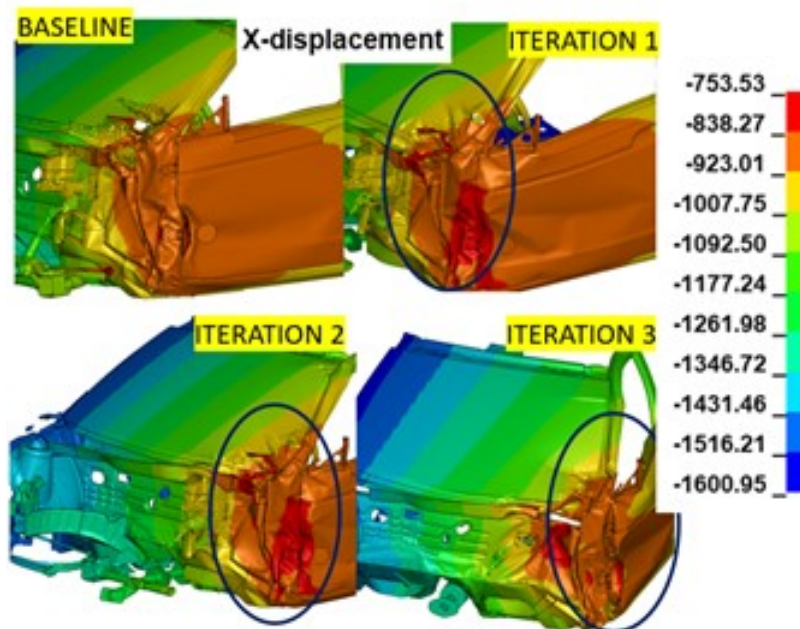

Figure E.31: X-displacement (intrusion) in the driver compartment for different weld positions on the A-Pillar



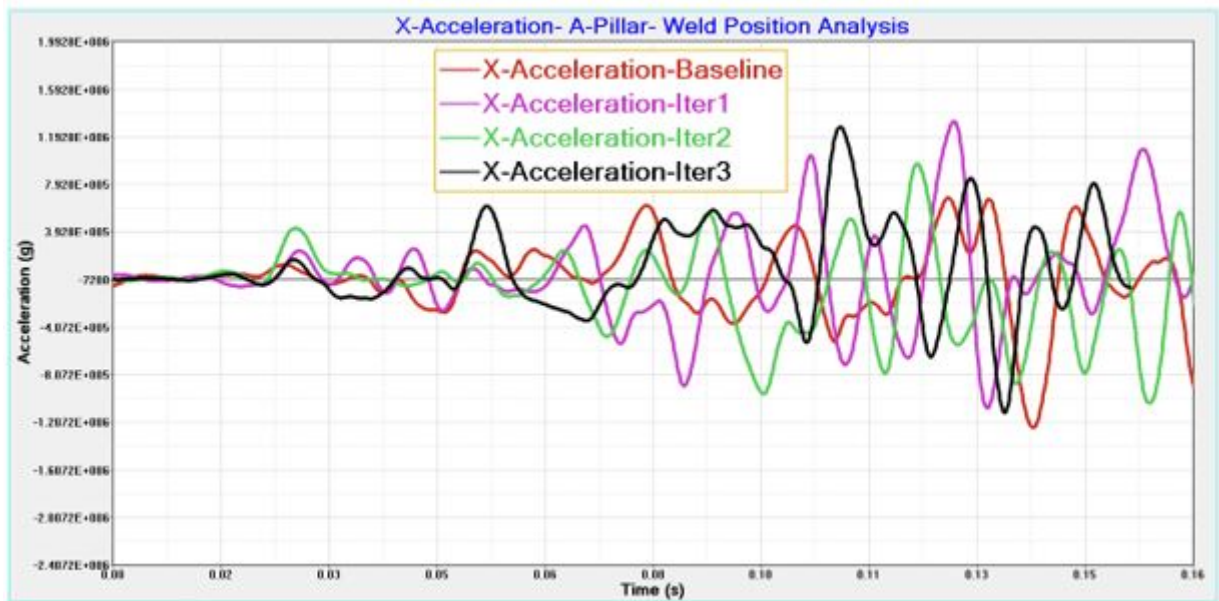

Figure E.30: X-Acceleration on A-Pillar for Weld Position Analysis

## E.6 Conclusions

The addition of UHSS steel members to a vehicle helps to improve structural integrity of the vehicle while also contributing to weight reduction of the vehicle. The strong material has its constraints while repairing the members and a knowledge about the influence of welding on these materials is crucial to ensure that safety performance is retained on the vehicle after a repair. This study brings to light the fact that the safety performance of a vehicle is modified after improper repairs are conducted on the vehicle as shown in Table E.32 The load path in the event of a crash is changed after structural UHSS members are welded. It is also observed that the impact of improper repairs on a vehicle is more sensitive in a few crash scenarios as opposed to some other loadcases. This study involves only welding at a single point on the A-Pillar, further research will be done in order to understand the influence of multiple welds on different UHSS members. It will include the study of impact of repairs on different structural members with respect to the crash loadcases. We plan to conduct a similar study on different vehicle types to understand if the impact of welding and improper repairs is higher on small vehicles or if it's same for all vehicle types.

Loadcase	Crash Performance Evaluation	
	Baseline	Weld Added to A-Pillar
IIHS Small-Overlap Frontal Barrier Test	✓	✓
NCAP Front Impact Test	✓	✓
IIHS Moderate Frontal Offset Test	✓	✓
IIHS Lateral Moving Deformable Barrier Test	✓	✓
Lateral NCAP Pole Test	✓	✓
NCAP Side Impact Test	✓	✓

	Meets Performance
	Acceptable Performance
	Marginal Performance
	Poor Performance

Figure E.32: Comparison of baseline vs modified vehicle crash performance across different loadcases

## E.7 Contact Information

Gulshan Noorsumar: [gulshan.noorsumar@uia.com](mailto:gulshan.noorsumar@uia.com) University of Agder, Norway

## E.8 Acknowledgments

The authors of this paper would like to acknowledge National Highway Traffic Safety Administration (NHTSA) and National Crash Analysis Center (U.S.) along with George Mason University for sharing access to the finite element models used during the study.

# References – Paper E

- [1] Paul Du Bois, Clifford C Chou, Bahig B Fileta, Tawfik B Khalil, Albert I King, Hikmat F Mahmood, Harold J Mertz, Jac Wismans, Priya Prasad, and Jamel E Belwafa. 2004.
- [2] Laetitia Theodora Aarts, JJ Commandeur, Ruth Welsh, S Niesen, Markus Lerner, Pete Thomas, Niels Bos, and Ragnhild Johanna Davidse. Study on serious road traffic injuries in the eu. *Luxembourg: Publications Office of the European Union*, 2016.
- [3] Zhaokai Li, Qiang Yu, Xuan Zhao, Man Yu, Peilong Shi, and Cilei Yan. Crash-worthiness and lightweight optimization to applied multiple materials and foam-filled front end structure of auto-body:. *Advances in Mechanical Engineering*, 9:1–21, 8 2017. ISSN 16878140. doi: 10.1177/1687814017702806. URL <https://journals.sagepub.com/doi/10.1177/1687814017702806>.
- [4] Guofei Chen and Aleksy A. Konieczny. Influence of ahss part geometric features on crash behavior. *SAE Technical Papers*, 4 2006. ISSN 0148-7191. doi: 10.4271/2006-01-1588. URL <https://www.sae.org/publications/technical-papers/content/2006-01-1588/>.
- [5] Advanced high-strength steel (ahss) definitions - worldautosteel, . URL <https://www.worldautosteel.org/steel-basics/automotive-steel-definitions/>.
- [6] Liang Huang, Min Kuo, and Benda Yan. Ahss application in roof strength. *SAE Technical Papers*, 2007. ISSN 26883627. doi: 10.4271/2007-01-0339.
- [7] Paul Kah, Markku Pirinen, Ramio Suoranta, and Jukka Martikainen. Welding of ultra high strength steels. *Advanced Materials Research*, 849:357–365, 2014. ISSN 1662-8985. doi: 10.4028/WWW.SCIENTIFIC.NET/AMR.849.357. URL <https://www.scientific.net/AMR.849.357>.
- [8] Uwe Schmortte. Crash-test results to analyse the impact of non-professional repair on the performance of side structure of a car. 2011.

- [9] Michael Schäffer, Ralf Sturm, and Horst E. Friedrich. Methodological approach for reducing computational costs of vehicle frontal crashworthiness analysis by using simplified structural modelling. *International Journal of Crashworthiness*, 24:39–53, 1 2019. ISSN 17542111. doi: 10.1080/13588265.2017.1389631.
- [10] Biswajit Tripathy and Sampath Vanimisetti. The beam-grid: Development of a full vehicle reduced order model for frontal, offset and side impact f2018/f2018-stn-024 - fisita. 10 2018.
- [11] Yucheng Liu. Development of simplified truck chassis model for crash analysis in different impact scenarios. *International Journal of Crashworthiness*, 15(5): 457–467, 2010.
- [12] Crash Simulation Vehicle Models | NHTSA, . URL <https://www.nhtsa.gov/crash-simulation-vehicle-models>.
- [13] H Singh, CD Kan, D Marzougui, and S Quong. Update to future midsize lightweight vehicle findings in response to manufacturer review and iihs small-overlap testing. *Report No. DOT HS*, 812:237.
- [14] IIHS. Small overlap frontal crashworthiness evaluation — crash test protocol, 2021.