



LTE- in Unlicensed Band: Medium Access and Performance Evaluation

by

Alexandre Kanyeshuli

Supervisor: Frank Y. Li

IKT 590 Master Thesis in Spring 2015

A Thesis Submitted in Partial Fulfilment of the Requirements for the Degree of Master of Science in Information and Communication Technology

Department of Information and Communication Technology
Faculty of Engineering and Science
University of Agder

Grimstad, 26 May 2015

Abstract

Long Term Evolution (LTE) technology is challenged by high data rate demanding services and increasing number of mobile phones which are equipped with Wi-Fi access capability. To respond to this challenge, 3rd Generation Partnership Project (3GPP) initiated a Study Item (SI) which investigates the co-existence of Wi-Fi and LTE technologies in the same unlicensed 5 GHz band. Given that Wi-Fi and LTE are originally designed to operate in totally different bands, unlicensed and licensed, it is difficult to achieve this coexistence for these two incompatible access technologies. Accordingly, 3GPP introduces the Listen Before Talk (LBT) mechanism to ensure the coexistence feasibility of both two access technologies in that band. This SI consists of License Assisted Access (LAA)-based LBT including Load Based Equipment (LBE) and Frame Based Equipment (FBE) mechanisms which may be designed to compete with Wi-Fi-based access mechanism towards a fair access on the shared channel.

In this thesis, we evaluate the performance of two newly proposed 3GPP medium access control (MAC) and Wi-Fi-based mechanisms under diverse scenarios with different parameter configurations. The evaluation is carried out through simulations and the considered performance parameters are Jain's fairness index (FI) and access opportunities obtained after multi-competitions on the shared channel. Furthermore, we propose two MAC mechanisms referred to as enhanced LBE (E-LBE) and enhanced FBE (E-FBE) and then evaluate and compare their performance with 3GPP MAC mechanisms.

Through extensive Matlab-based simulations, we observe that 3GPP mechanisms do not function well since, depending on scenario, some of them get higher opportunities while others are starved, leading to poor performance in terms of FI. At the same time, we observe that the performance of the proposed E-LBE mechanism varies, depending on the selected scenarios. On the other hand, the performance of the proposed E-FBE access mechanism increases the FI up to 47%, achieving an average FI of 97%. This result demonstrates that fair access and effective coexistence between MAC mechanisms are achieved by employing E-FBE. Correspondingly, end users can get benefits from the coexistence of LTE and Wi-Fi with fair access and equal opportunities.

Keywords: LTE and Wi-Fi, LAA-based LBT, unlicensed spectrum, coexistence and fair access, performance evaluation, enhanced access mechanisms

Preface

This thesis is based on the work performed for the IKT590 final year Master's thesis project which corresponds to 30 ECTS credits as part of the Master program in Information and Communication Technology at University of Agder. This work started from 2 January and ended on 26 May, 2015.

I would like to express my sincere thanks to my Supervisor Professor Frank Y. Li for his guidance and kind advices throughout this project. Through his supervision, I learnt lot of things related to research work in both technical and organizational aspects of the thesis project.

I also would like to express my gratitude to Mr. Sunday Joseph, and to other academic and administrative staff at the Department of ICT, University of Agder, classmates and friends for their help and encouragement during my Master's studies, especially those who contributed to the finalization of this thesis project.

May the Almighty God bless you all.

Alexandre Kanyeshuli

Grimstad

26 May 2015

Table of Contents

List of Figures.....	v
List of Tables.....	vi
Abbreviations.....	vii
1 Introduction.....	1
1.1 Background and Motivation.....	1
1.2 Problem Statement and Thesis Goals.....	3
1.3 Research Approaches and Solutions.....	4
1.4 Limitations and Key Assumptions.....	5
1.5 Thesis Outline.....	6
2 Theoretical Background.....	7
2.1 Licensed and Unlicensed Band.....	7
2.2 Coexistence of the LAA and Wi-Fi-based MAC mechanisms.....	7
2.2.1 Carrier sensing adaptive transmission.....	7
2.2.2 Requirements supporting Wi-Fi and LAA coexistence.....	8
2.3 LBT Enabling Techniques.....	8
2.4 Deployment Scenarios of LTE and Wi-Fi in Unlicensed Band.....	10
2.4.1 Other potential applications of the upcoming LTE-U band.....	10
2.4.2 LTE-U operation modes.....	11
2.4.3 Intended LTE and Wi-Fi deployment in the shared band.....	12
2.5 Jain's Fairness Index.....	12
2.6 CSMA/CA.....	13
2.6.1 CSMA/CA backoff mechanism.....	13
3 Implementation and Enhancement of LAA-based LBT Access Mechanisms.....	14
3.1 Background of the LAA-based LBT Access Mechanism.....	14
3.2 Matlab Implementation of the LTE-U MAC Mechanisms.....	14
3.2.1 Principle of the LBE-based access mechanism.....	14
3.2.2 Implementation of the LBE-based access mechanism.....	16
3.2.3 Principle of the FBE-based access mechanism.....	17
3.2.4 Implementation of the FBE-based access mechanism.....	18
3.2.5 Implementation of the CSMA/CA access mechanism.....	19
3.2.6 Implementation of hybrid access mechanism.....	20
3.3 Enhanced FBE: the Proposed Access Mechanism and its Implementation.....	20
3.3.1 Principle of the E-FBE-based access mechanism.....	21
3.3.2 Implementation of the E-FBE-based access mechanism.....	21
3.4 Enhanced LBE: Enlarged CW Size for LBE traffic.....	22
3.5 Chapter Summary.....	23
4 Performance Evaluation of LAA-based LBT Access Mechanisms.....	24
4.1 Scenarios and Evaluation Parameters.....	24
4.2 Scenario 1: Numerical Results of LBE-based MAC Mechanisms.....	25
4.2.1 LBE1 and LBE2-based combination with variable backoff scaler (q_1).....	25
4.2.2 LBE and Wi-Fi-based combination with variable Wi-Fi transmission time.....	27
4.2.3 LBE and FBE-based combination with variable channel occupancy time.....	28
4.3 Scenario 2: Numerical Results of FBE-based MAC Mechanism.....	30
4.3.1 FBE and other FBE-based combination.....	30
4.3.2 FBE and Wi-Fi-based mechanism with variable Wi-Fi transmission time.....	30
4.3.3 FBE and Wi-Fi-based mechanism with variable channel occupancy time.....	31
4.4 Scenario 3: Numerical Results for LAA-based LBT in Hybrid Scenario.....	31
4.4.1 Hybrid scenario with variable backoff scaler.....	31
4.4.2 Hybrid scenario with variable Wi-Fi transmission time.....	33
4.4.3 Hybrid scenario with variable channel occupancy time.....	34
4.5 Chapter Summary.....	36
5 Performance Evaluation of the Proposed Backoff Algorithms.....	37

5.1	Numerical Results of the E-FBE-based Mechanisms.....	37
5.1.1	E-FBE and other E-FBEs with variable channel occupancy time.....	37
5.1.2	E-FBE and original LBE with variable backoff scaler	39
5.1.3	E-FBE and LBE with variable channel occupancy time	40
5.1.4	E-FBE and Wi-Fi with variable channel occupancy time	42
5.1.5	E-FBE in hybrid scenario with variable backoff scaler	43
5.1.6	E-FBE in hybrid scenario with variable CoT and Wi-Fi transmission time	44
5.2	Numerical Results of E-LBE-based Access Mechanisms.....	46
5.2.1	E-LBE and other E-LBEs with variable backoff scaler	46
5.2.2	Performance of the E-LBE and Wi-Fi schemes with variable backoff scaler	47
5.2.3	E- LBE in hybrid scenario and other combinations.....	48
5.3	Performance Comparison: 3GPP versus the Proposed Access Mechanisms.....	48
5.3.1	Discussion on the comparison process.....	49
5.3.2	Performance comparison of 3GPP versus the E-LBE access mechanisms.....	49
5.3.3	Performance comparison of 3GPP versus the E-FBE-based mechanisms	51
5.4	Chapter Summary	52
6	Conclusions and Future Work.....	54
6.1	Conclusions.....	54
6.2	Contributions.....	55
6.3	Future Work.....	55
	<i>References</i>	56
	<i>Appendices</i>	58

List of Figures

Figure 2.1 CSAT mechanism for sharing of ISM band.....	8
Figure 2.2 Channel sensing strategies for interference avoidance.	9
Figure 2.3 Adaptive LBT operation mode in LTE-U system.....	10
Figure 2.4 Carrier aggregations for the operation in LTE-U system	11
Figure 2.5 Basic CSMA/CA backoff mechanism for Wi-Fi.....	13
Figure 3.1 Example of adaptive frame length and backoff period for LBE.	15
Figure 3.2 Principle of the LBE-based LBT with ECCA procedure	16
Figure 3.3 LBE procedure starting with random backoff counter.	17
Figure 3.4 Example of FBE with fixed frame period	17
Figure 3.5 Synchronous and asynchronous FBE-based LBTs	18
Figure 3.6 Operation mode of FBE-based LBT	19
Figure 3.7 Overview of medium sensing process for Wi-Fi.	19
Figure 3.8 Generic procedure of shared channel access for hybrid scheme.	20
Figure 3.9 Overview of E-FBE access mechanism.....	21
Figure 3.10 Implementation procedure of E-FBE-based LBT.....	22
Figure 4.1 Fairness for LBE1+LBE2 with variable backoff scaler	26
Figure 4.2 FI and access opportunities for LBE+Wi-Fi with variable transmission time.....	28
Figure 4.3 Channel opportunities and FI for LBE+FBE with variable channel occupancy time.....	29
Figure 4.4 Channel opportunities and FI for FBE+Wi-Fi with variable Wi-Fi transmission time.....	31
Figure 4.5 Access opportunities & FI in hybrid scenario with variable backoff scaler (case one).	32
Figure 4.6 Access opportunities & FI in hybrid scenario with variable Wi-Fi transmission time.	33
Figure 4.7 Channel opportunities & FI in hybrid scenario with variable channel occupancy time.	35
Figure 5.1 Channel opportunities and FI of two E-FBEs with variable channel occupancy time.....	38
Figure 5.2 Access opportunities and FI of the E-FBE and original LBE with variable backoff scaler...	40
Figure 5.3 Performance of the E-FBE+LBE with variable channel occupancy time ($q_2=32$).	41
Figure 5.4 Access opportunities and FI of the E-FBE+ Wi-Fi with variable channel occupancy time.	42
Figure 5.5 Access opportunities & FI of the E-FBE in hybrid scenario with variable backoff scaler. ...	44
Figure 5.6 Fairness of the E-FBE in hybrid scenario with variable channel occupancy time.	45
Figure 5.7 Channel opportunities & FI between two E-LBEs with variable backoff scaler.	47
Figure 5.8 Channel opportunities and FI for E-LBE and Wi-Fi with variable backoff scaler.....	48
Figure 5.9 Performance comparison: 3GPP versus E-LBE-based schemes	51
Figure 5.10 Performance comparison: 3GPP versus the E-FBE-based schemes.....	52

List of Tables

Table 3.1 Parameters used for the performance evaluation of the LTE-U mechanisms.....	22
Table 4.1 Scenarios and parameters used for evaluating the LAA-based mechanisms.	24
Table 4.2 FI indices and channel access opportunities for two LBEs ($q_2=32$).	27
Table 4.3 Numerical results for FI between LBE and Wi-Fi ($q_1=32$).	27
Table 4.4 Results for FI between LBE and FBE with variable channel occupancy time ($q_1=4$).	29
Table 4.5 Numerical results showing FI for FBE+Wi-Fi with variable Wi-Fi transmission time	30
Table 4.6 Numerical results of the hybrid scenario with variable backoff scaler q_1 (case one).	33
Table 4.7 Numerical results of the hybrid scenario with variable Wi-Fi transmission time.	34
Table 4.8 Numerical results of the hybrid scenario with variable channel occupancy time.....	35
Table 5.1 Access opportunities and FI of E-FBE1+E-FBE2 with variable channel occupancy time.....	38
Table 5.2 Numerical results of the E-FBE and original LBE with variable backoff scaler.	39
Table 5.3 Numerical results of the E-FBE+ LBE with variable channel occupancy time ($q_2=32$).	41
Table 5.4 Fairness indices for E-FBE+ Wi-Fi pair with variable channel occupancy time.	42
Table 5.5 Numerical results of the E-FBE in hybrid scenario with variable backoff scaler	43
Table 5.6 Access opportunities & FI in hybrid scenario with variable channel occupancy time.	44
Table 5.7 Numerical results of two E-LBEs with variable backoff scaler.....	46
Table 5.8 Numerical results of E-LBE and Wi-Fi with variable backoff scaler.....	47
Table 5.9 Summary of all numerical results generated based on FI.....	49
Table 5.10 Performance of 3GPP versus the E-LBE-based mechanisms.....	50
Table 5.11 Numerical results of 3GPP versus E-FBE-based mechanisms.....	51

Abbreviations

3GPP	3rd Generation Partnership Project
ABS	Almost Blank Subframe
ACK	Acknowledgment
AIFS	Arbitration Inter-frame Space
ALBT	Adaptive Listen-Before-Talk
AP	Access Point
CA	Carrier Aggregation
CCA	Clear Channel Assessment
CoT	Channel Occupancy Time
CS	Carrier Sensing
CSMA/CA	Carrier Sense Multiple Access with Collision Avoidance
CW	Contention Window
DCF	Distributed Coordination Function
DFS	Dynamic Frequency Selection
DIFS	Distributed Inter Frame Space
DL	Downlink
ECCA	Extended CCA
EDCA	Enhanced Distributed Channel Access
E-FBE	Enhanced Frame Based Equipment
E-LBE	Enhanced Load Based Equipment
eNodeB	Evolved Node B
ETSI	European Telecommunications Standards Institute
FBE	Frame Based Equipment
FDD	Frequency Division Duplex
FI	Jain's Fairness Index
FTD	Flexible Transmission Duration
ISM	Industrial, Scientific and Medical
LAA	Licensed Assisted Access
LBE	Load Based Equipment
LBT	Listen-Before-Talk
LTE	Long Term Evolution
LTE-U	LTE in Unlicensed band
MAC	Medium Access Control
RAT	Radio Access Technology
SI	Study Item
SINR	Interference plus Noise Ratio
STA	Station
TCG	Tuneable Coexisting Gap
TDD	Time Division Duplex
TDMA	Division Multiple Access
TxWiFi	Wi-Fi Transmission Time
UE	User Equipment
U-NII	Unlicensed National Information Infrastructure
WLAN	Wireless Local Area Network

1 Introduction

Currently, there are intensive discussions about the demand for additional bandwidth in LTE-based technology in order to satisfy high data rate demanding services. To address this problem, 3GPP initiated a study related to the exploitation of Industrial, Scientific and Medical (ISM) band in line of making LTE and Wi-Fi-based technologies to coexist and operate together in 5 GHz spectrum band. The LBT has been initiated and tested for supporting the afore-mentioned coexistence. However, lots of questions are still asked about this coexistence feasibility of the two systems which are almost incompatible. In this chapter, we explore the background overview of this study, explain the main focus of this thesis work which evaluates and enhances the MAC mechanisms in LTE-U band.

1.1 Background and Motivation

The LTE wireless technologies have been designed to operate in licensed band with the main goal of maximizing spectral efficiency and optimizing user experience [1] while unlicensed band was unsuitable for technology using that band. Also, the ISM band is currently hosting 802.11 (Wi-Fi) and (Bluetooth) and 802.15.4 (ZigBee) within 2.4 GHz and Unlicensed National Information Infrastructure (U-NII) in 5 GHz bands [1]. However, due to the current services demanding large spectrum band, 3GPP started the study which will allow licensed access technologies to be hosted in unlicensed band and co-operate together in that shared band. But this requires careful design as it may completely block Wi-Fi-based access networks originally operating in unlicensed and favors LAA-based access technologies.

Wi-Fi was originally designed to operate in unlicensed band. And it uses contention-based algorithm to mitigate interferences with other Wi-Fi access technologies, either from the same or different operators. Hence, the new integrated LAA-based should also follow the same procedures in 5 GHz band according to the requirements defined in European Telecommunications Standards Institute (ETSI) [2]. And this will lead to the best coexistence and performance of LAA and Wi-Fi systems in that band. Although LAA-based mechanisms operate with primary carrier for arguing the transport of data traffic, Wi-Fi also works with secondary carrier in ISM band and will still have the ability to share the spectrum with other systems including LAA-based systems through its polite contention-based algorithm. That is, Wi-Fi will have to use Carrier Sense Multiple Access (CSMA) for listening to the channel in order to sense if the channel is idle or not by using LBT. As mentioned earlier, this mechanism also has to be adapted by LAA-based systems for better coexistence and efficient performance of both LAA and Wi-Fi based mechanisms in the shared 5 GHz band [3], [4].

According to [2], the adaptive LAA-based system consists of two LBT schemes such as LBE and FBE which are considered to give better performance for eNodeB or UEs once deployed in unlicensed band and meet the goals defined by 3GPP [5]. In addition to this, different countries use different requirements for LBT to access spectrum band [3]. This enabled 3GPP study to standardize the defined objectives and set parameters which suit better coexistence of Wi-Fi and other LAA-based MAC mechanisms in the shared band. Therefore, different studies have been done by different companies and researchers towards the achievement of this better coexistence and ensure fair spectrum access for both wireless access technologies in considerations.

The LBT is the mechanism which is based on energy detection. However, some studies do not show clear details about it and consider some other parameters. Regarding this matter, the work in [6] considers two thresholds of antenna power transmitter, where one is for identifying transmissions related to Wi-Fi stations (STAs) and another for LTE user equipments (UEs) in line of interference avoidance and better coexistence of these two mechanisms. Also, this study demonstrates the performance of coexisting LTE and Wi-Fi where smaller cells (pico, femto cell) and wireless local area network (WLAN) were deployed for office scenarios at the same band of 900 MHz band. For these deployments, the system level based simulation results showed that LTE systems can perform

better than Wi-Fi which is considerably impacted and forced by LTE to remain in listen mode for long time [6], [7].

Similarly, Wi-Fi STAs usually transmit with maximum power and when they get opportunity to access channel, they may interfere with LAA nodes on the shared channel. On the other hand, LAA-based systems possess subframes with significant power which may block Wi-Fi systems operating on the same shared channel. It can also be added that there is no way considered for coordinating mutual interference between LAA and Wi-Fi systems. Because of the above reasons, the authors of [6] introduced the concepts of Interference plus Noise Ratio (SINR) at each node engaged in transmission and Almost Blank Subframes (ABS) [8] which mute some frames in one layer and prevent the interference in others. In this way, these systems ensure a better coexistence once combined with other existing coordinated strategies [7]. However the well-defined access algorithms such LBT (which are not considered for this existing work) would be taken into considerations as it allows a deep study related to the frame control; which definitely, ensures better coexistence for both two access technologies as defined by 3GPP.

Regarding the demand for high bandwidth, the study in [9] claims that the growth of current complex equipments degrade the overall user throughput for Wi-Fi due to packet collisions. However, this can be adjusted by the increase of Contention Window (CW) length which may favor a larger number of Wi-Fi users by enabling large completion space (large CW). But again, this may lead to the higher overhead which in turn lowers the overall throughput. On the other hand, the number of users can be limited by lower power of STAs rather than APs. According to [9], the diversion of some traffics to other access networks can solve the afore-mentioned problems. And this is achieved by deploying simultaneous Wi-Fi and LAA-based access networks since both have the capability of easily adopting CSMA algorithms towards capacity and coverage enhancement as well as better coexistence. In addition to this, the authors of [9] pointed out the benefit of Wi-Fi and LTE related to the provision of data offloading for both up and downlinks which gives trust to the possibility and better performance of Wi-Fi and LTE allocated onto the shared band. As specified in [2], [10] and briefly explained in [1], the spectrum band of 5 GHz is considered to be the best band which can support this coexistence. Therefore, we expect the user experience and performance improvement to users in real world applications since Wi-Fi and LAA-based systems have different characteristics and capabilities once deployed in the 5 GHz shared band.

The study of coexistence is the foundation of the LAA and Wi-Fi access mechanisms deployment in the same band. For this issue, WLAN and LTE have been evaluated in [11] for downlink (DL) traffics about that coexistence on the license-exempt band (5 GHz). However, in the most evaluated cases, LTE showed the best performance over WLANs since WLANs are based on Carrier Sense Multiple Accesses with Collision Avoidance (CSMA/CA) while in LTE, the bandwidth is divided into blocks and assigned to different users by eNodeB. And this allow WLANs to have access to the channel by reducing the time allocated to LTE [11].

Many other studies pointed to the above mentioned coexistence, but there is no work about the performance of LBT mechanism for both LAA-based LBT and Wi-Fi systems in the unlicensed 5 GHz band; which originally, is considered to be the main foundation to control the transmission time (frame length) in order to allow a better coexistence and fair access to the shared spectrum. In this work, we explore the adaptive channel access mechanisms such as LBT in which devices are allowed to access the channel, if there are no other devices present on the same channel, i.e, the transmission is prevented for other devices if the channel is busy [2], [5]. For this work, we will consider LAA-based LBT mechanisms which are more likely to provide the fairest channel access and effective coexistence with other LAA-based as well as Wi-Fi systems in the shared band. More specifically, our focus is based on two main LTB mechanisms such as LBE-based and FBE-based MAC systems contending for the channel access on the shared channel with other LTE-U MAC mechanisms including Wi-Fi. We will evaluate the performance of each scheme individually as well as hybrid scenarios towards the best coexistence of LAA and Wi-Fi systems as explained in the following

section. Therefore, for the application purpose, not only the fairest access and best coexistence are achieved; by also, the avoidance of inter-technology handover between Wi-Fi and LTE- based access technologies. Furthermore, there are many works done related to this topic as previously mentioned. However, given the requirements for LTE-U coexistence and the goals to achieve, we observe that what have done is not enough. Also, for the studies already done and the ongoing activities, the work on how to design the MAC mechanisms which can be used in LTE-U band is not clear. Then, these two observations trigger our motivation to study this subject.

1.2 Problem Statement and Thesis Goals

The exponential increase of services demanding higher data rate has a big impact on both wireless access technologies such as LTE and Wi-Fi systems. Correspondingly, users are affected since they want services to be accessed anywhere and at any time. This causes the spectrum users to claim for improving capacity in those wireless network technologies and for additional spectrum which is now becoming more insufficient [7], [12], in order to ensure better coverage and fair access to the channel. Currently, 3GPP is addressing this problem through the proposed SI [2], [13] to occupy the unlicensed band which has enough spectrum band capable of supporting both LAA and Wi-Fi systems at 5 GHz.

Although unlicensed band has been unsuitable for licensed frequency, it has been shown in some research work that it is possible for Wi-Fi and LTE to coexist in the same shared band and produce better performance in response to the above described problem. In addition to this, data offload in LTE-U band is currently carried out by Wi-Fi to the cellular network [9] which promises the possibility of Wi-Fi to better coexist with LAA-based systems in the LTE-U shared band. Another example is the LTE small cell deployed as the complement to LTE macro cell for addressing the need for higher capacity [8], [9]. In the shared LTE-U band, this can also be applied where APs may be incorporated within LTE small cell or deployed in the neighbour areas separately. From the above, we can confirm the possibility of Wi-Fi and LAA-based system deployment in 5 GHz band. Therefore, we have to evaluate the coexistence feasibility of these two wireless access technologies as the first step of this study, even though LAA-based system was shown to provide better coverage and spectral efficiency than Wi-Fi when they are operating in the shared LTE-U band [9]. In addition to this, regulations and requirements have to be applied to achieve the target of making these mechanisms “good neighbours”, which lead to better coexistence between them, fair access and equal opportunities on the shared channel.

As licensed LTE is traditionally focussing on maximizing spectral efficiency and optimizing user experience; in LTE-U band, it should be designed in such way that there is no impact on Wi-Fi or other Radio Access Technology (RAT) services such as data, videos and voices [5]. Hence, other parameters including throughput, latency, jitter and some others should be counted in order to be sure that the targeted fair access and effective coexistence are achieved. However, in our thesis, we will only determine how fair the channel is by exploring channel access opportunities in order to meet better co-channel coexistence.

Different channel sensing mechanisms have been adopted in different works, where UEs or STAs have the capability of detecting other RAT networks during transmission or reception of packets in LTE-U band. Therefore, in this thesis we adopt LBT procedure defined in [2] and study the performance of two adaptive LAA-based mechanisms namely LBE and FBE as well as Wi-Fi systems in the shared band. In this study, we are targeting to know how many times and to which extent each access technology can reach the shared channel without impacting others. This is done through competitions for the channel access.

We have previously mentioned that LAA-based LBT consists of two adaptive equipments with different working principles and use the CSMA mechanism to detect energy level before initiating their respective transmissions. This is done through the application of Clear Channel Assessment

(CCA) time for the channel observation [2]. Since LBE, FBE and Wi-Fi schemes adopt Carrier Sensing (CS) mechanism, equipments using similar schemes can also use the same CS mechanism to co-exist and equitably share the same 5 GHz band. It is also important to note that Wi-Fi uses CSMA/CA which adopts DCF algorithm. This work is carried out towards the solutions of problems related to unfairness faced by users operating in the shared band. We are interesting in determining how to achieve the improvement of both co-existing wireless access network and how to ameliorate them for better coexistence. Hence, the main goals of this thesis work are to evaluate the performance of two popular schemes proposed by 3GPP and to propose the enhanced mechanisms in line of achieving a fair access and effective coexistence in LTE-U band. More specifically, the goals of this thesis are summarized hereafter as follows:

- Study and summarize the principle of LTE-U/LAA mechanisms and compare them with CSMA/CA.
- Investigate and compare MAC mechanisms proposed by 3GPP under various LTE-U and Wi-Fi scenarios with different configurations.
- Propose MAC mechanisms to improve the performance of LTE-U/LAA which suit better under a specific scenario.
- Evaluate the performance of the proposed MAC mechanism analytically and by simulation.

Although the CSMA is applied to all three schemes differently, their deployment in the shared band ensures fair access to the channel in the LTE-U band; and this insurance concerns not only the coexistence between Wi-Fi and LAA-based mechanisms but also between hybrid LTE-U mechanisms. Here, hybrid LTE-U deployment is referred to as the combination of LBE, FBE and Wi-Fi-based equipments operating simultaneously in the same LTE-U band.

1.3 Research Approaches and Solutions

To address the problem of unfairness in the shared LTE-U band, we initially started with literature related to this field where we found very few research papers related to this idea, since it is a fresh SI initiated from around 2013 by 3GPP. Many discussions and researches about this SI are still going on and it is intended to be implemented in 2017 for Release 13 which is not finalized yet. For this matter, reports and concluding documents for the ongoing 3GPP meetings about this SI are mostly used to accomplish this thesis work. Here, the main part is based on the newest proposals from CableLabs [14] and Ericsson [15] companies of November 2014 and February 2015 respectively.

While evaluating the above mentioned coexistence of LAA-based LBT with Wi-Fi and other access technology networks, we observed the unfairness of the proposed mechanisms where some of them are quite completely blocked if they attempt to access the channel. The example given is the licensed LAA-based system which does not leave the channel [3] and continuously transmits signaling and channel information, allowing it to always have priority on channel access and blocks Wi-Fi schemes.

Also, by considering the packets sizes and their operation mode, results from Matlab simulation demonstrate that equipment using FBE schemes have difficulties to compete with others, especially when they compete with Wi-Fi schemes which is mostly blocked. That is, if FBE transmission is successful, it is likely for the next transmission to be successful again. If the transmission fails, the next transmission also fails; and the problem becomes worse if the packet size is very large. Regarding the operation mode, FBE-based equipment uses a CCA for every fixed frame; and it transmits from 1 to 10 ms if the channel is free ($CCA \geq 20 \mu s$) while it stays silent for the whole fixed period for a failed CCA. For LBE, a random backoff number N is selected from $[1, q]$ where q is the backoff scaler selected from [4, 32], and it adopts a CSMA during backoff mechanism. The after, it transmits for $(13 \times q)/32$ ms, i.e if the applied CCA fails, it defers until the channel becomes idle again and can transmits if N reaches zero [15]. Similar approach is done by Wi-Fi which uses

CSMA/CA based DCF algorithm. However, Wi-Fi follows exponential backoff mechanism. Due to the above described procedures, hybrid LTE-U can be affected during channel access.

We observed that LAA-based mechanisms do not comply with defined 3GPP regulations and requirements [4]. Therefore, the adjustment of q parameter for channel occupancy time could be one solution for that. Ericsson in [15] showed that LBE can perform better if it initially starts the competition with a random backoff counter. Through Matlab simulation, we will verify this observation, and further propose the improved schemes which will be consisting of enlarging LBE CW size, by setting another q interval from 64 to 100. Within this new interval, simulations showed that LBE-based mechanism can perform well. In addition to this, FBE-based LBT is not flexible with other FBEs if all equipments are synchronized. This is because both equipments use the same CCA of at least $\geq 20 \mu\text{s}$; hence, once synchronized, they can attempt to access the channel simultaneously and result in serious collisions. This problem is noted and further addressed by proposing the introduction of random backoff mechanism into FBE-based MAC mechanism, which produces better performance. With these two proposed solutions, the fairness between equipments is greatly ameliorated. This is also confirmed by Jain's fairness index (FI) introduced to evaluate the fairness between all schemes in order to achieve our goals. Note also that FI is measured in percentages (%); hence, our target is to achieve FI by 100% which indicates the fairest access and effective coexistence of both schemes on the shared band.

To come up with this conclusion, extensive Matlab simulations are used to implement both 3GPP and the proposed schemes. These are further compared to assess the fairness between them as well their coexistence status on the shared channel. We therefore evaluate all schemes including hybrid LTE-U, since the results show that if one of them has poor performance, the whole hybrid LTE-U system is affected. We have also checked and realized that there is no other work done for the performance comparison of LBE, FBE and Wi-Fi based mechanisms for the equipments operating in 5 GHz band; which is our primary focus. Based on the Matlab results, we are convinced that, the mentioned effective coexistence and fair access can be achieved which also solve the problem of data offloading, inter-technology handover as well as high demand for channel capacity in the shared band.

1.4 Limitations and Key Assumptions

The scope and assumptions of this thesis are described as follows:

Throughout this thesis work, we primarily focus on performance evaluation and comparison of adaptive LAA-based LBT. Those are LBE, FBE and Wi-Fi MAC mechanisms for the sake of efficient and fair channel access as well as enabling better coexistence between them as defined by 3GPP regulations. In this study, we do not discuss the deployment scenarios; rather, we solely highlight the performance of APs/STAs or eNodeBs/UEs for the matter of fairness.

Regarding requirements, several high level functionalities are defined [13]. Those are Dynamic Frequency Selection (DFS), LBT protocol for adaptive channel access and fairness, and Flexible Transmission Duration (FTD) to enable a global solution. In our work, we focus on adaptive LBT mechanisms rather than other targets in [13]. Also, some studies consider Enhanced Distributed Channel Access (EDCA) algorithm as one of the options for LBTs. In our case, we limit this work to DCF algorithm which is followed by Wi-Fi, and can also be adopted by LBE scheme in a different way but by keeping the same idea.

Another assumption is about the energy detection before data transmission. Here, we assume that the energy level is above threshold value for a busy channel while for an idle channel, the threshold energy is the highest. More importantly, we assume that transmissions for any of all mechanisms are successful once eNodeBs/UEs or APs/STAs have chance to access channel, and also that acknowledgements (ACKs) are successfully received. For Wi-Fi, this assumption means that, the transmissions are successful in the first Contention Window, i.e, $[0, CW_{min}]$ where $CW_{min} = 15$

time slots. For easing the complexity of this study for any transmissions, we again consider that every user engaged in competition for the channel access has always packet to send. It is also important to emphasize that the work done during this master thesis project is not a real life implementation. Rather, it is based on Matlab simulation.

1.5 Thesis Outline

While Chapter 1 gives the overall introduction for the whole work carried out throughout this thesis, the remaining chapters of this thesis are organized in the following way:

- Chapter 2 presents other related background technologies which enabled the generic insight of this work including ISM services and wireless access mechanisms.
- Chapter 3 consists of the detailed description of principles and implementation of LTE-U access mechanisms. Here, we explain how these mechanisms are implemented including both 3GPP and new proposed mechanisms.
- Chapter 4 presents the performance of the LAA-based LBT mechanism, and highlights the weak points which need improvement in order to achieve the targets.
- Chapter 5 describes in details the performance of the new proposed MAC mechanisms towards the enhancement of both LAA-based LBT and Wi-Fi mechanisms in the shared band. It also provides the performance comparison between 3GPP and the new proposed MAC mechanisms for all combinations and scenarios considered throughout this thesis.
- Chapter 6 concludes the thesis by providing the overall summary of this thesis and points leading to the contributions and future work.

2 Theoretical Background

A massive growth of mobile data traffics which require high data rate in wireless networks enables a today's technology to also grow quickly. The proposed 3GPP project about the coexistence of LTE with Wi-Fi is considered to be a solution to the demand of bandwidth which satisfies this amount of services. In this chapter, we present the main background from which this new study is based on.

2.1 Licensed and Unlicensed Band

Depending on the operator, most of the best current services are given by licensed spectrum particularly in low-frequency bands [16]. Due to the large number of end users, this band is facing a rapid exhaustion caused by the growth of channel demand by large number of subscribers [17]. On the other hand, the unlicensed spectrum is considered by cellular operators as a complementary tool to increase their services [10]. Hence, the industry is currently claiming to take advantages of deploying LTE technologies in unlicensed spectrum of 5 GHz as proposed by 3GPP in its SI initiated around 2013 [4]. This is in line of identifying the necessary requirements for LTE to coexist with Wi-Fi within the same 5 GHz band. While LTE is designed to operate in licenced band, Wi-Fi is also designed to operate in unlicensed spectrum; also known as ISM band [12]. However, the coexistence of these two most used broadband wireless access networks in the same spectrum requires a careful study as it may results in degradation of the performance for one of them [4], [12], since they are not only dissimilar but also incompatible when operating in the same band [12].

2.2 Coexistence of the LAA and Wi-Fi-based MAC mechanisms

While designing Wi-Fi and LAA-based mechanisms to efficiently coexist in unlicensed 5 GHz band, it is of paramount important to be careful since one of the mechanisms may be impacted by others [1]. The requirement set by 3GPP in the Release 11 about LTE standards will allows Wi-Fi and other LTE-U access network to peacefully coexist and operate in the same ISM band. Even though, the standard assumptions push those network mechanisms to harmoniously use the same spectrum band, the intended LTE fairness seems to be impractical since LTE does not renounce its licensed spectrum heritage with LTE-U, because it still uses it for continuous transmission of signalling and channel control signals [3]; and it is also responsible of carrier aggregation which ensures the best coexistence [1]. The requirements should be respected to ensure that LAA-based schemes be "good neighbours" of Wi-Fi in the shared band. And it has been shown in [1] that one of the mechanism supporting this coexistence is the channel selection which allows the interference avoidance by application of medium sensing mechanisms [1].

In addition to this, STAs and APs use DCF, as a Wi-Fi default channel access mechanism to exchange data, control, and frame management [12]. DCF uses a contention-based protocol known as CSMA/CA [7]. In these protocols, nodes sense the channel before any transmission by using CCA and backoff procedures to know the status of the channel (busy or idle) and defer their transmissions accordingly; which in turn lowers the probability of collisions [3], [7]. There are other mechanisms supporting Wi-Fi and LAA coexistence in LTE-U band which will be discussed in the following sections.

2.2.1 Carrier sensing adaptive transmission

The Carrier-Sensing Adaptive Transmission (CSAT) is one of the algorithms used to allow the coexistence of Wi-Fi and LTE-U small cells in unlicensed spectrum if there is no clean channel available and when there is a hyper-dense deployment [1]. This means that the increase in channel demand results in reduction of duty cycle. This algorithm is based on channel measurement and allow access networks in consideration not to interfere with each other; rather, it allows the adaptation of its duty cycle based on medium utilization [1] and favors fair sharing of the channel by

tuning on and off the LTE signal; occupies the channel for some period of time and leave the channel free for other networks to take advantage [1]. This process is illustrated in Figure 2.1.

In addition to this, CSAT senses the traffic in the network and identifies how frequent traffics occur. Depending on the traffic amount, It allows LTE-U to schedule them during those time intervals when other traffics are not present [3]. Also, similar to some other sensing mechanisms like CSMA/CA, this algorithm is aiming at providing coexistence of Wi-Fi and LTE-U in the same concept of Time Division Multiple Access (TDMA). This coexistence is based on medium sensing [1]. Hence, CSAT is almost similar to CSMA but it differs from the latter mechanism by the possession of longer latency and longer medium sensing capability of around 10 to 200 *ms* than that of CSMA which is around 10 *ms* [1].

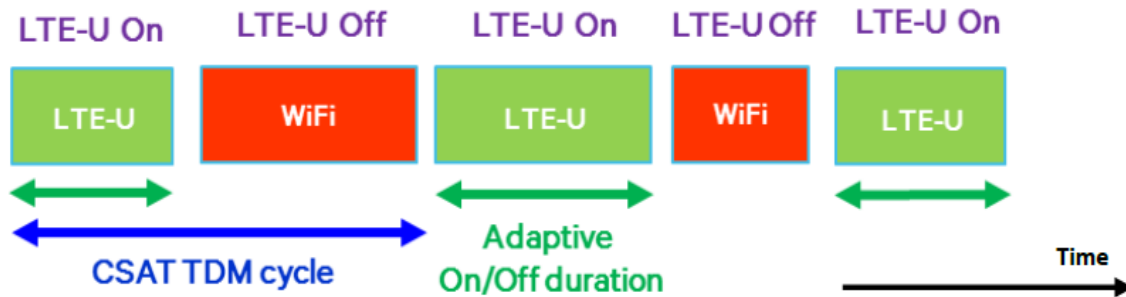

Figure 2.1 CSAT mechanism for sharing of ISM band [1].

2.2.2 Requirements supporting Wi-Fi and LAA coexistence

For a better operation in unlicensed band, there are some functionalities supporting fairness metrics and criteria [18] in addition to those defined in [2], and this allows an effective coexistence of LAA with other RATs including Wi-Fi or with other LTE systems in the shared band. One of those functionalities is the compliance with the regulatory requirements for which fair usage of unlicensed band must respect regional regulatory bodies which include system bearer with the help of DFS, LBT for channel sensing through CCA application [18] etc. LAA coexistence and compatibility with other systems is another parameter which should also be taken into account.

In addition to this, the requirements should also be designed so that they argue the flexibility for the region or global inter-network implementation [18]. For example, the initial LBT was originally supported in Japan and Europe while it was not available in US and Korea [3]. About deployment scenarios, the intended LAA design specifications shall support both indoor and outdoor deployments since there have been some restrictions in power limit and indoor use. Also, only small cells deployment should be targeted by LAA and reuse scenarios from the study of small cell enhancement [18]. This is in line of ensuring better coverage and responding to the high demand of addition capacity by end users.

2.3 LBT Enabling Techniques

LBT mechanisms have been studied in the earlier research works for medium detection. Studies in [19] and [20] highlight the importance of LBT mechanisms in sensing the primary signal opportunities by secondary users, i.e, secondary users decide if they have opportunity to the channel access before transmission; and this is in line of interference avoidance. That is, if secondary users communicate successfully without violating interference constraints, the channel is said to be opportunistically detected according to [19]. This primary sensing by secondary users was studied under the presence of noise and fading; and it has been shown that even if perfect detection were done, the spectrum opportunity remained subjected to error [19]. However, the authors of the study in [20] tried to improve this mechanism by allowing secondary users to opportunistically and intelligently have access to the under-utilized primary band when secondary users have multiple

packets to send after a single channel detection. This work introduces the threshold concept which is compared to the incoming signals. Authors, show that the time for sensing has to be long enough in order to achieve the required detection performance; hence, weak signals need a very long sensing time, which may degrade opportunities for secondary transmissions [20]. Figure 2.2b illustrates the primary sensing by secondary users (A and B) and the communication is initiated upon presence of primary users. That is, the users A and B can communicate only if the transmission from A does not interfere with any primary user in red cycle, while at the same time, the reception at B does not have impact on the primary user in blue cycle [19].

Similarly, the work in [21] discusses about the spectrum or dynamic sharing where different access systems have the capability of managing interferences between them and try to transmit if they have enough information about the status of the channel got through sensing mechanism. In this study, the interference limitation is a major concern since the system may fail to achieve the capacity if there is a poor interference management [21]. The authors consider heterogeneous networks where two strategies of interference management can be applied: one being the treatment of interference as noise, where each adjacent transmitter can reach a certain level of information depending on the channel quality. However, many existing works consider opportunistic spectrum access based on packet-level sensing [20] as shown in Figure 2.2a. Another strategy is the LBT which is based on perfect channel sensing. Although, this may depend on the traffic burstiness, it showed the best performance compared to the first strategy because of CW use; especially when the number of nodes sharing the medium is larger [21].

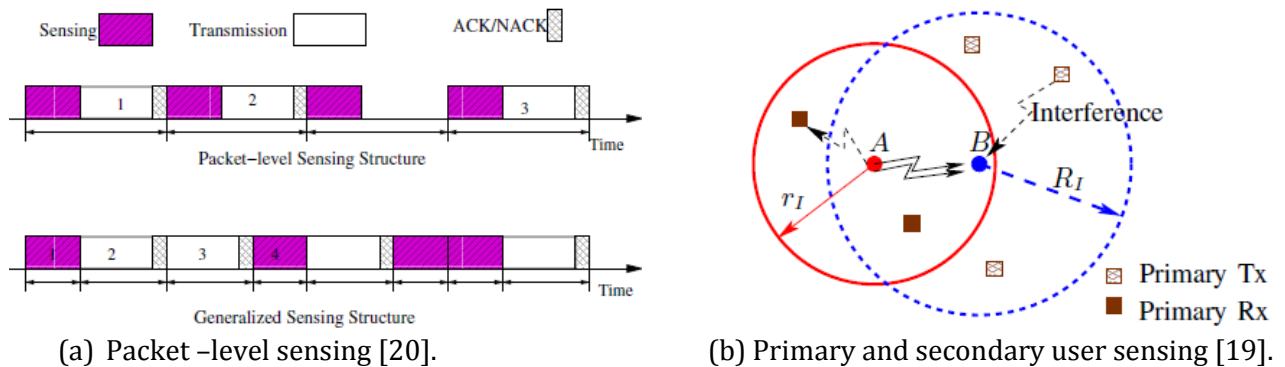

Figure 2.2 Channel sensing strategies for interference avoidance.

The CW utilization and the support of large number of users allow LBT-based mechanism to be currently adopted in wireless access technology networks. For example, in the shared unlicensed band, multiple LTE and Wi-Fi users can share and use equitably the spectrum band of 5 GHz through the use of LBT backoff mechanism, although LTE was designed to operate in licensed band [7], [22] as suggested by 3GPP. The current LBT-based mechanism can easily follow CSMA algorithms by detecting energy levels of other users before any transmission. This has the advantages of effectively solve coexistence issues of access technologies in the shared spectrum as it ensures the interference avoidance between Wi-Fi and LAA in the shared band. In addition to this, studies in [22] insists that fair coexistence can be achieved through both non-coordinated and coordinated scenarios. Here, authors propose the evolved LBT backoff mechanism known as Adaptive LBT (ALBT) which assesses the channels and leave behind a certain number of gaps referred to Tuneable Coexisting Gaps (TCG), and this may allow ALBT to easily deals with available channels in LTE-U band which will be pooled together [22]. The TCGs and LBT mechanism are illustrated in Figure 2.3.

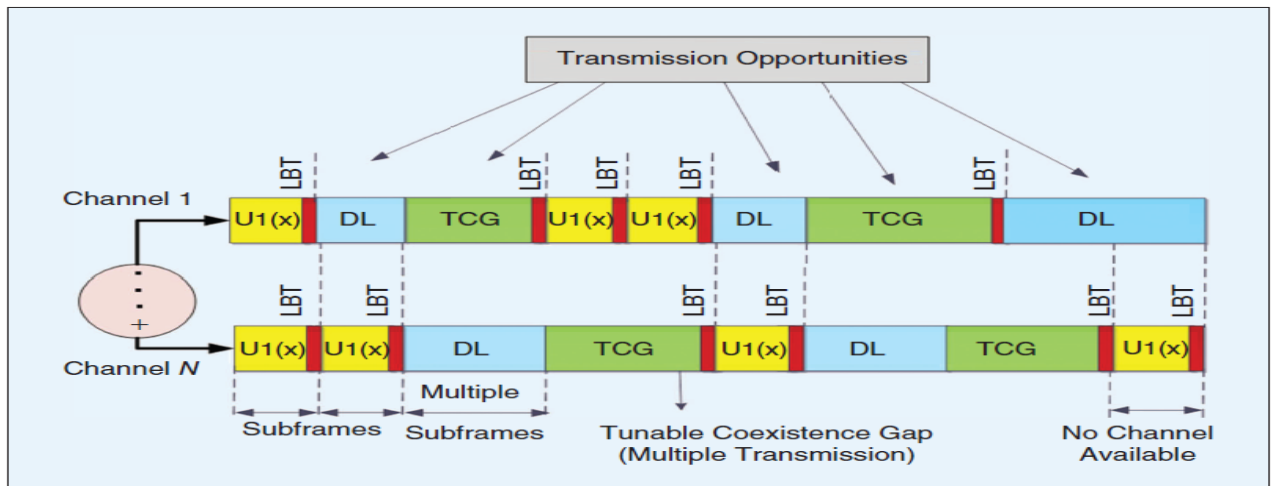

Figure 2.3 Adaptive LBT operation mode in LTE-U system [22].

Here, LAA-based system switches between a given number of available channels in order to avoid their selfishness of always occupying the channels. That is, LAA-based equipment will continuously sense the channel by checking if there are some other users occupying the shared channel; and if the channel is deemed to be unoccupied, LAA-based equipment transmits. But later, after transmission, it rescans the channel again. If a new channel is identified as idle, LAA-based equipment moves to that new channel and leaves behind a coexisting gap for other access technologies such as Wi-Fi to take advantage and peacefully occupy the left channel [22]. It is important to note that, once gaps are left behind, LTE systems will stay offline and do not initiate any transmissions for both data, control and reference signals in the left gaps. Rather, it continues using other new channels; which will increase the opportunity for Wi-Fi systems to grab the channel. If Wi-Fi has multiple frames to send, LTE-U allows a TCG long enough to satisfy those Wi-Fi multi-frame transmissions.

2.4 Deployment Scenarios of LTE and Wi-Fi in Unlicensed Band

As described in [4], the deployment of small cell, macro cell should consider carrier aggregation in order to comply with requirements and efficiently coexist with Wi-Fi systems in the shared band. The performance of shared Wi-Fi and LAA-based mechanisms will also be impacted by the level of synchronisation from either intra-operator or inter-operator synchronisations, where synchronous or asynchronous schemes can be considered. However, it has been shown that in most cases, asynchronous schemes with other radio access technologies are considered for requirement compliancy as specified by 3GPP. In the following section, we briefly explain the proposed deployment scenarios and other hidden reasons for the future shared spectrum.

2.4.1 Other potential applications of the upcoming LTE-U band

The shared LTE-U band has some other higher potential applications in addition to that responding the demand for additional spectrum discussed above. As found in [23], some of them are achieved because of the higher data rate resulted from the improved spectral efficiency as a result of better coverage in the unlicensed deployment area. Regarding the network management, the shared LTE-U band is intended to be a better solution for the network set up. Through the exploitation of the this band, multi-solution management leading to security and authentication will be avoided, since every subsystem of existing individual access technology was treated and managed separately before integration of the two access technologies [23].

Since LAA-based mechanisms will be transparent to core network for LTE, the need for upgrading any evolved packet core element will be prevented [23]; hence, it will be easier to perform the network maintenance, as it will use integrated technologies in shared band. Note here that, all these advantages have been shown either experimentally or by simulations. Also, there is no LTE installation permission required since LTE networks are able to achieve higher capacity than Wi-Fi, and eNodeB can easily operate in aggregation mode with other existing LTE eNodeBs. In addition to this, LTE-U principle depends on existing LTE core network and it will use the same security and authentication mechanisms, i.e, there is no modification of core network domain required for the shared 5 GHz band [23]. Furthermore, this study is intended to enable cellular networks to co-operate with Wi-Fi communication systems without any priority and co-exist together in the shared band without any discrimination between users; either primary or secondary users [8].

2.4.2 LTE-U operation modes

LAA and Wi-Fi operation modes are importantly supported by carrier aggregation mechanism developed in Release 10 up to Release 12. For this integrated technology, the associated unlicensed carrier works as secondary carrier under control of the primary carrier for licensed LTE. This allows a feasible and flexible offloading between both licensed and unlicensed carriers [24] as shown in Figure 2.4. The only difference between these carriers resides on the primary carrier which has the responsibility of transmitting control and signaling information which includes system acquisition, authentication, mobility management as well as paging, access and registration [3]. Also, regardless of the presence of primary carrier in the shared band, the unlicensed band can allow simultaneously Time Division Duplex (TDD), both UL and DL or only DL carrier. However, Frequency Division Duplex (FDD) is supported by LTE where eNodeB and LTE mobile users can communicate simultaneously through different frequencies [3].

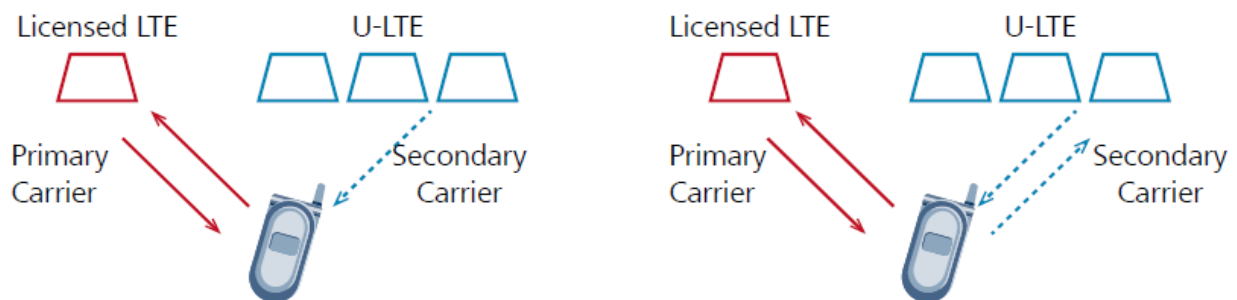

Figure 2.4 Carrier aggregations for the operation in LTE-U system [24].

In order to comply with Wi-Fi, LAA system is friendly hosted in the shared band if it uses TDD in almost the same way as Wi-Fi does and adapts its operation mode in 5 GHz band [3]. This can be done in a couple of ways: either LAA system uses TDD duplex in similar way as LTE uses it in licensed band or LAA system utilises supplemental downlink feature [1], [3]; where the downlink paths between UEs and eNodeB are given by a block of spectrum, but in this case there is no UL channel. Because of this, LTE strengthens UL channel and associates it with another different FDD spectrum. That means, supplemental downlink allows the possibility of having the bandwidths for both asymmetric UL and DL channels.

For the application purposes, supplemental downlink works as carrier aggregation for LTE downlink [3]. Since the licensed primary cell always maintains connections between eNodeB and end users, the LTE eNodeB can itself ensure effective communication through continuous checking for the idleness of the channel or for a channel which is slightly loaded, hence LBT is applied prior to any transmission [23]. And by considering loads on the channel, LTE can perform better than Wi-Fi in case of high load. Other parameters that support unlicensed band operation are feedbacks when UEs are located in the shared LTE-U coverage area. This includes channel quality information which allows the determination of the quality to achieve in the unlicensed band [23].

2.4.3 Intended LTE and Wi-Fi deployment in the shared band

Since the operation mode of LAA-based LBT mechanism in the shared band depends on the licensed primary and unlicensed secondary carriers, their deployment will also depend on the carrier aggregation mechanism. The first targeted deployment scenarios consist of small cells operating in the unlicensed spectrum by following the concepts of CA [4], [24]. These deployments include both indoor and outdoor deployments, as well as non-co-located and co-located small cell deployments within primary and secondary carriers. In this case, one or more licensed primary or secondary unlicensed carriers can be used during small cell deployments [4].

Additionally, the non-ideal or ideal backhaul can be considered in some cases since small or macro cells consider CA for better operation in unlicensed band; hence for both unlicensed and licensed operation, backhaul should also have that ideality [4]. However, in most cases, high percentage of spectrum is given to LAA-based schemes while leaving less spectrum to unlicensed band; and this means that, in most of the time, the primary users have the right to the spectrum band than secondary users leading to the interference avoidance which may be caused by lower priority users [23]. This issue must be taken into account during the study, as it leads to unfairness between two access technologies and destroys our target of achieving fair and effective coexistence.

2.5 Jain's Fairness Index

In wireless communication systems, sharing services and resources is of paramount important since all users are considered to have equal opportunities for channel access through MAC mechanisms. Fairness is one of metrics to measure or estimate whether users have achieved fair shares of services or not. This is calculated by considering Jain's FI [25] in line of determining fairness to the channel access and maximizing throughput. However, FI is not used only for throughput; other parameters can be estimated depending on the target of the systems under considerations. These include channel access probabilities, resource allocations, energy consumption and so on. In this thesis, we apply FI to compare channel access opportunities in the shared band. According to [25], this FI can be calculated using Equation (2.1).

$$FI = \frac{(\sum_{i=1}^n x_i)^2}{n \sum_{i=1}^n x_i^2} \quad (2.1)$$

where x_i is the normalized values and they are calculated as $x_i = \frac{T(i)}{O(i)}$; with $T(i)$ and $O(i)$ being the measured and optimal values for any given parameter under study, and n denotes the number of users. According to [25], and for any given parameter, FI considers all users in any given system, including those who may have been assigned less resources. For example, the FI for the resource allocation of the competing hosts in [25], is the number which measures whether resources are distributed fairly or unfairly among users, and this is deemed to be long-term fair if every user has access to those resources by a probability of k/n for an effective long time.

In addition this, FI should be independent of any scale and continuous over that long time period, and also bounded between 0 and 1. Therefore, depending on number of users (n); $1/n$ is estimated to be the worst case whereas 1 (100%) is the best index. For example, using Equation (2.1) for three users; if 80% of resources are allocated in a fair way, 20% are unfairly allocated. And this can be extended to n users or for multi-competitions experiment.

2.6 CSMA/CA

In Wi-Fi-based systems, STAs and APs use DCF, to exchange data, control, and management frames. This DCF uses CSMA/CA mechanism which is a CW-based protocol [7], [2], where nodes sense the channel before they initiate any transmission. They use a procedure called CCA which is continuously applied to the channel to determine if it idles or busy. If CCA is not successful, the channel is declared as busy, hence the transmission is deferred. While it adapts the back off mechanism, once the channel has been idle, and is idle for Distributed Inter-frame Space (DIFS). This mechanism allows the reduction of collisions with Wi-Fi and other coexisting mechanisms in ISM band [7], [6]. On the other hand, LTE-U possesses a high flexibility for resource allocation and doesn't use carrier sensing mechanism before transmission. That is, the LTE eNodeB allocates the radio communication sub-channels in order to continuously estimate the channel status [7] and transmit signalling and control channel information, such as system acquisition and mobility management; which makes the shared LTE-U to be referred LAA [3].

2.6.1 CSMA/CA backoff mechanism

The use of random backoff number before data transmission has a paramount importance of reducing collisions in the contended channel [26]. As briefly discussed above, the CSMA/CA mechanism for Wi-Fi-based systems uses the concept of backoff mechanism where a uniform random backoff number is selected from a certain range $[0, CW_{min} - 1]$ [27], [26] where CW_{min} is the minimum CW ranging from 15 time slots to the maximum CW (CW_{max}) of 1023 time slots [26]-[28]. For all protocols using 802.11, the priority for wireless access is controlled by inter-frame space (IFS) between transmission of frames [27].

Initially, if a channel is idle for the shortest CCA and idle for DIFS, an STA can transmit immediately as illustrated in Figure 2.6. If a channel is occupied, an STA generates a uniform random backoff number from $[0, CW_{min} - 1]$ before transmission. The random backoff counter is decremented if the channel is sensed to be free and frozen if the channel is busy. The process will be resumed when the channel is sensed to be idle again for more than a DIFS period and the transmission is initiated once the back-off counter reaches zero [27], [28]. Earlier work assumed that frames are successfully received and no Acknowledgment (ACK) is sent while the current study considers ACK as a proof of successful reception of frames. For other work, the use of RTS/CTS also known as four way hand shake is considered to mitigate collisions and avoid hidden terminal problems [26], [27]. The failed transmission causes the STA to double the CW up to a maximum value for the next backoff stage, and then a new random backoff number is selected using the process described above. Note here that the selected random backoff number follows the binary exponential distribution. The same process is repeated until the frame is successfully transmitted. If the frame is still not received up to a $RetryLimit$, it will be dropped [27].

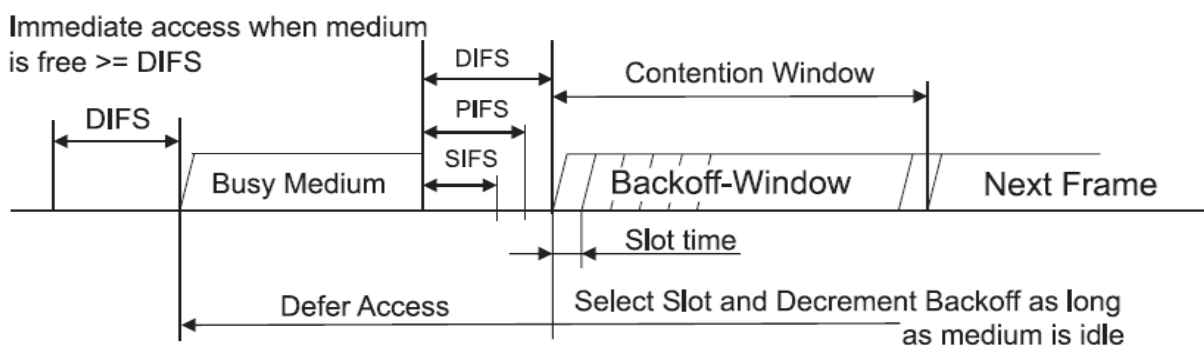

Figure 2.5 Basic CSMA/CA backoff mechanism for Wi-Fi [29].

3 Implementation and Enhancement of LAA-based LBT Access Mechanisms

Backoff mechanism is very crucial in wireless access technologies especially for channel access procedures when users are aiming at achieving fair allocation of services and resources. The study of LBT as one of the backoff algorithms used by LAA-based equipments in the shared 5 GHz band enforces LBT MAC mechanism to be applied efficiently in order to achieve better coexistence between other LAA and Wi-Fi-based access mechanisms. As mentioned earlier, we used Matlab simulation to implement this mechanism and demonstrate its feasibility. Therefore, in this chapter, we give the detailed descriptions of the LAA-based LBT mechanisms and show how the implementation is carried out for both 3GPP and new proposed MAC mechanisms in line of achieving the best fairness between them once applied in the shared band.

3.1 Background of the LAA-based LBT Access Mechanism

For the view point of channel resource allocation, we refer LBT procedure as the mechanism where eNodeBs or UEs have the capability of applying CCA to sense if the channel is occupied or not, by using energy detection. In this work, we have used parameters specified in [2] and [15] to apply this CCA in unlicensed spectrum. According to the requirement, CCA used in LBT is equivalent to at least $20 \mu s$ for both LAA-based LBT mechanisms. That is, the channel is observed for the period equivalent to CCA and then the power level of the equipment is assessed and compared to the threshold value. In [2], threshold power is set to -75 dBm .

During the channel scanning, if $CCA \geq 20 \mu s$, the threshold power exceeds the power in the channel, the channel is deemed to be unoccupied, otherwise the channel is considered to be busy. Since we have used Matlab simulation, we only considered one condition that if the channel is sensed for $CCA \geq 20 \mu s$, the channel is deemed to be idle and busy otherwise. This process is used in LAA-based LBT mechanism to check the idleness of the channel during the competitions with other LAA or Wi-Fi access schemes. CCA is used to sense the channel in different ways depending on the type of equipment used as it will be described in the following sections. On the other hand, Wi-Fi uses CSMA/CA mechanism to compete with other equipments using LAA-based mechanisms. We implemented different schemes for both mechanisms and evaluated their performance by considering different combinations.

3.2 Matlab Implementation of the LTE-U MAC Mechanisms

As mentioned above, the backoff mechanism under study consists of both LBE and FBE-based equipments. We implemented these schemes in Matlab based on the work in [15] and [14] and this implementation is in line of meeting the requirements initiated by 3GPP [4] towards the effective and fair coexistence of all schemes in the shared band. During this implementation, we let LAA-based and Wi-Fi schemes compete for the channel and we evaluate how many times the individual scheme has got opportunities to access channel. In the following, we explain every scheme individually. We also give details on how it is implemented as well as parameters considered during the simulation.

3.2.1 Principle of the LBE-based access mechanism

User Equipments using LBE scheme adopt the contention algorithm by using CCA application. For LBEs, the channel is occupied for an adaptive transmission time defined as "Channel Occupancy Time (CoT)", which also determines the size of frame being transmitted because the frame structure is not fixed for LBE systems. CoT is calculated using Equation (3.1), where N is the random backoff counter selected from 1 to q . That is, $N \in [1, q]$ where q is a fixed backoff scaler selected from 4 to 32 and it is fixed for any given equipment [29]. The CW for LBE depends on the random number N . Since the

time slot is fixed for $20 \mu s$, CW is therefore determined by $20 \times N$. For our simulation, we used the uniform distribution to determine this random backoff number (N).

$$CoT = \frac{13 \times q}{32} \tag{3.1}$$

Figure 3.1 shows an example of variation of LBE contention window and frame size depending on the values of N and q respectively. According to this example as it is shown in Figure 3.1a, we assume that UE has occupied the channel for 1.625 ms calculated using Equation (3.1) for a fixed $q = 4$. Immediately after transmission, a new random counter $N = 3$ is selected from q varying from 1 to 4 since q is fixed for any given UE. Here, we assume that a UE selects a random number as long as it has a packet to send and initiates the next transmission cycle. In Figure 3.1b of the same example, CoT is evaluated using the same equation as 6.5 ms for random counter $N = 8$ and for q value fixed at 16. Hence, this variation of CoT and random counter N , indicate that the frame size and CW also vary depending on the values of q . We followed the proposals in [15] where initial CCA check is immediately followed by Extended CCA (ECCA) check prior to any transmission in order to achieve efficient coexistence with Wi-Fi and LAA-based systems.

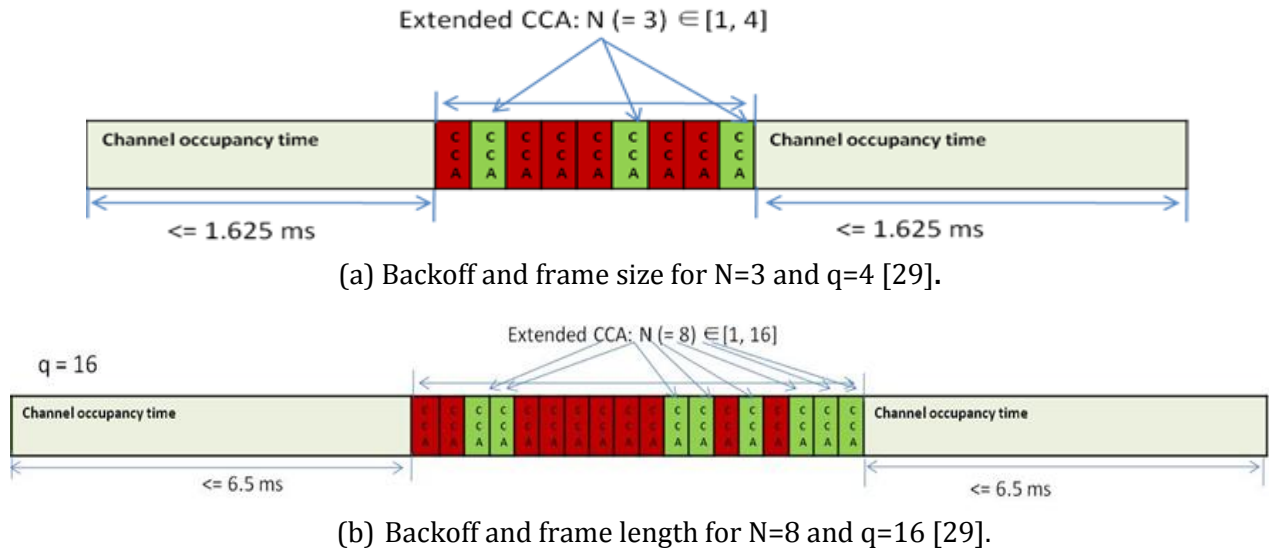

Figure 3.1 Example of adaptive frame length and backoff period for LBE.

The procedure of implemented backoff mechanism for LBE is shown in Figure 3.2. We adopted the algorithm in [15], where LBT procedure always begins with a random backoff counter N selected from interval 1 to q as it is already mentioned above; and by following the uniform distribution. For the simulation of this scheme, we allow equipments using LBE algorithm to scan the channel by applying an initial CCA check (T_0). Once this CCA is unsuccessful, it means that the channel is busy; and then CCA is continuously repeated until it is successful, indicating that the channel is idle for other users to enter competition [15]. An initial CCA which is successful is immediately followed by an ECCA check with T_1 duration and adopts the contention window procedure using the selected backoff counter (N). The CW for LBE is evaluated as $CW = 20 \times N$. If the channel is considered unoccupied during ECCA, the backoff counter N is decremented by one; and it is frozen if the channel is busy.

Following the above procedure, the equipment performs a continuous sensing, and if the backoff counter reaches zero ($N = 0$), the data is transmitted immediately; and a new random number is selected before another new initial CCA is again applied to start the next transmission. In this case, if we deeply analyze the described situation, it means that a successful transmission can happen after at least $N+1$ time slots, including the initialization CCA. Since all slots in LBE contention window have equal length ($20 \mu s$), two consecutive slots ($T_0 + T_1 = 2T_0$) are observed as unoccupied before

any transmission. Thus, this ensures the long deferring period for other competitors to take advantage. For example, $2T_0 = 40 \mu\text{sec}$ can be considered to be enough to open room for Wi-Fi whose DIFS is $34 \mu\text{s}$ and time slot is $9 \mu\text{s}$ in the unlicensed shared band, i.e., $(34 + 9) \mu\text{s}$. Therefore, this long CW will allow Wi-Fi users to better coexist with other LAA users in the shared band [15]. It can also be noted that, after each transmission, the LBT procedure resumes with a new random counter N and follows the above described process of applying initial CCA and ECCA respectively.

3.2.2 Implementation of the LBE-based access mechanism

By following the principle explained above, we implemented LBE-based access mechanism using the flowchart illustrated in Figure 3.2, which shows the procedure and all steps used during this implementation. This mechanism follows CSMA with linear CW depending on the selected uniform backoff counter N .

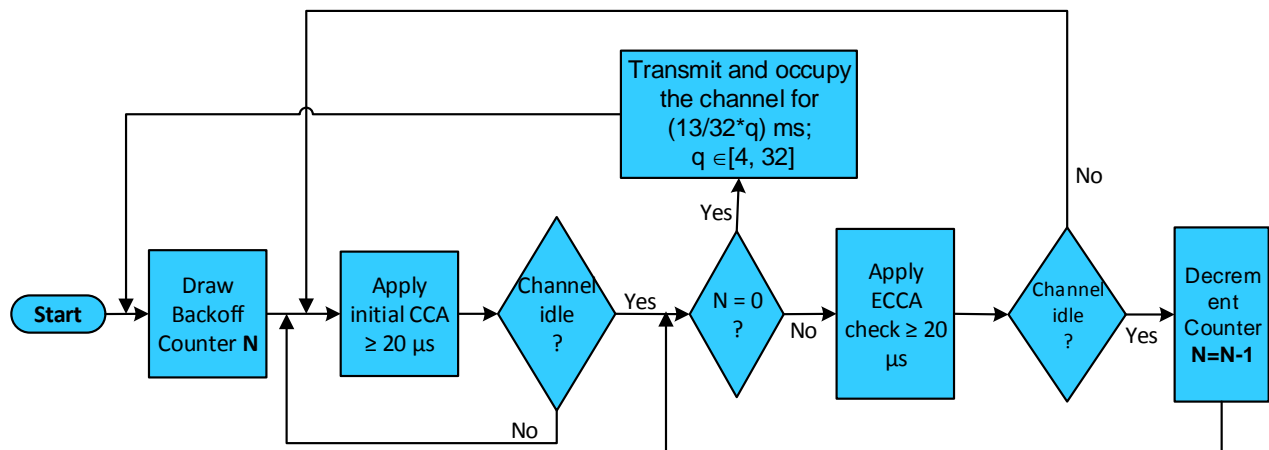

Figure 3.2 Principle of the LBE-based LBT with ECCA procedure [15].

The following is the summary of steps showing the implementation of the LBE-based LBT:

- The algorithm starts by selecting the random backoff counter N from the interval 1 to q , where q is a positive integer ranging from 4 to 32; meaning that this random backoff counter must also be integer value.
- After selecting a random backoff counter, initial CCA check is applied to the channel for $CCA \geq 20 \mu\text{s}$, to check for the idleness of the that channel. If it is not idle, CCA is applied again, otherwise the process continues to the next step.
- Having sensed the channel and found it idle for $CCA \geq 20 \mu\text{s}$, the algorithm checks if the counter N has reached zero; if it is the case ($N=0$), the LBE-based equipment transmits immediately and it occupies the channel for a duration equivalent to CoT calculated by Equation (3.1), and then the process reverts and restarts with a new counter N . For the other case ($N \neq 0$), it enters the next steps.
- ECCA ($\geq 20 \mu\text{s}$) is applied to the channel. If ECCA is successful, the random backoff counter is decremented by one; otherwise it defers and the process checks channel's idleness again by using initial CCA. The steps are repeated until the data is successfully transmitted.

The illustration in Figure 3.3 shows an example of LBE transmission procedure which starts by selecting a random backoff number $N = 4$. It can be seen that, if CCA fails, the equipment freezes while it continuously applies ECCA. Over the time, the new random number is selected after each transmission.

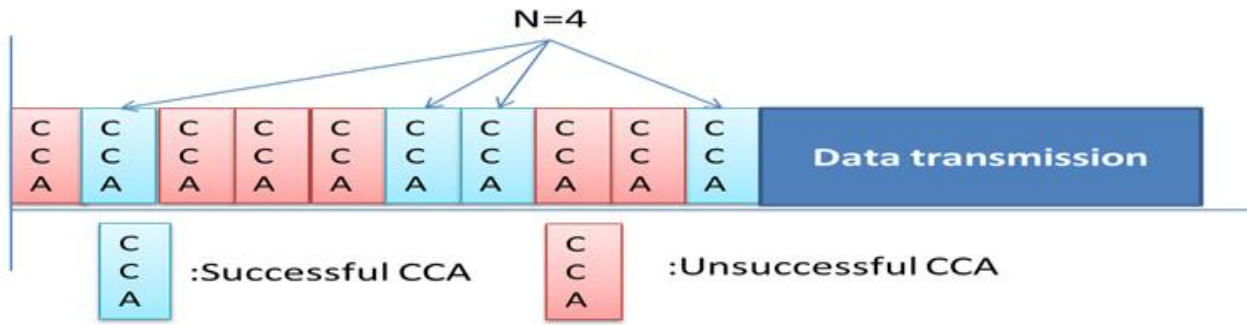

Figure 3.3 LBE procedure starting with random backoff counter.

3.2.3 Principle of the FBE-based access mechanism

In FBE-based LBT schemes, equipments are allowed to perform CCA to sense if the channel is idle, and this is done for every fixed frame period [15]. Similar to LBE, equipments using this scheme observe the channel for CCA time duration to detect energy level of other transmitters already occupying the channel which is compared to a pre-defined threshold value. If the channel is detected for a time equivalent to $\geq 20 \mu s$, the threshold energy is considered to be higher than that of the channel; hence the channel is reported as idle; and the equipment can immediately initiate its data transmission. For FBE schemes, the transmission time is fixed and it ranges from 1 to 10 ms [4], [15]. Therefore, if the equipment has a chance of accessing the channel, it occupies it for a fixed time period, also known as CoT specified by the operator, and then waits for a period equal to 5% of CoT, for the next transmission [15].

Similarly, the channel is reported as occupied by other users, if the threshold value is found exceeded by the power level of the channel; and this happens for the observation time less than CCA. That is, if $CCA < 20 \mu s$, the channel is reported as busy since the power of equipment occupying the channel exceeds the threshold power level. In this case, the equipment defers for the whole next fixed frame period, and there will be no transmission during that fixed frame period [15],[29]. However, once the channel is accessed, it will be occupied immediately upon successful CCA, up to 10 ms; meaning that for FBE, the data of maximum frame size can be transmitted in 10 ms. An example of FBE procedure is illustrated in Figure 3.4.

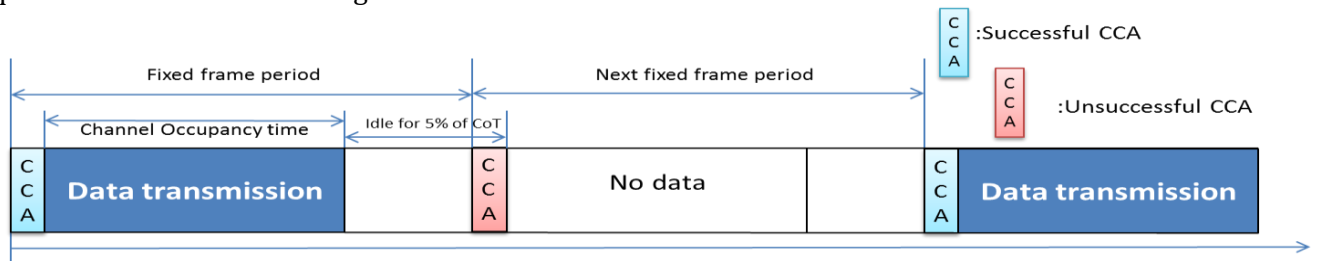
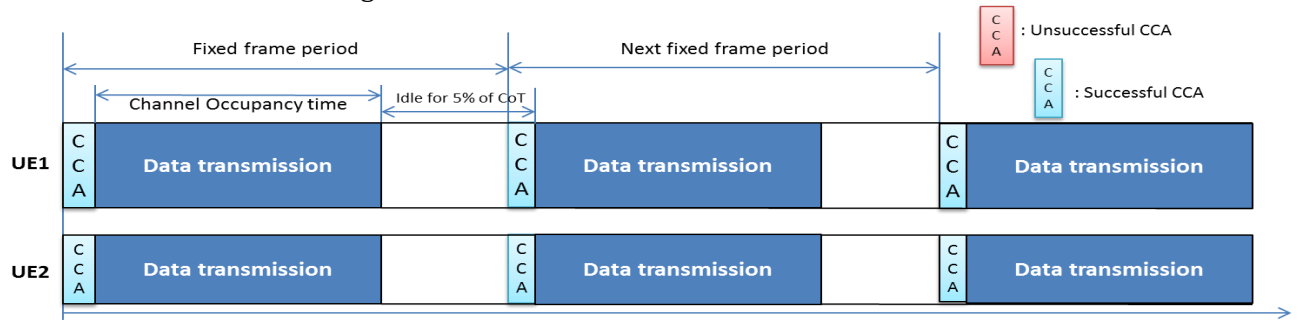

Figure 3.4 Example of FBE with fixed frame period [29].

It has been shown in [15] that FBE-based LBT schemes have advantages fitting with LTE frame structure, however it is more difficult for them to compete with other LAA-based LBT and Wi-Fi schemes for channel access in the shared band. The main reason is that FBE-based mechanisms apply CCA once while LBE and Wi-Fi depend on the CW to initiate a new transmission. The problem is worsened for a longer fixed frame size and if there is higher traffic on the channel.

Synchronization is also another challenge for FBE-based LBT during channel access. Since the duration of CCA is the same for FBE-based schemes, FBE equipments may find the free channel at the same time if they are synchronized; and this leads to the high probability of collisions, as the equipments can transmit simultaneously. On the other hand, if equipments are asynchronous, some of them get definitive access to the channel while others are completely blocked [15]. Figure 3.5a and Figure 3.5b illustrate those challenges for FBE-based LBT mechanisms. In our simulation, we

implemented asynchronous FBE scheme and show its impact on other LAA and Wi-Fi schemes if they are operated in the same band. However, to address this problem, we propose a new FBE-based scheme as it is explained later in the next sections. For FBE, it is assumed that if one UE is transmitting, another one is waiting until the channel is made available for other competitors. However, in most of time, the equipment which is able to grab the channel before another always becomes the winner since the size is fixed and there is a high possibility for CCA to be always successful as the waiting time is large. As results, one UE definitively occupies the channel and blocks others as it is illustrated in Figure 3.5b.



(a) Synchronized CCA for FBE based LBT: Collision [15].

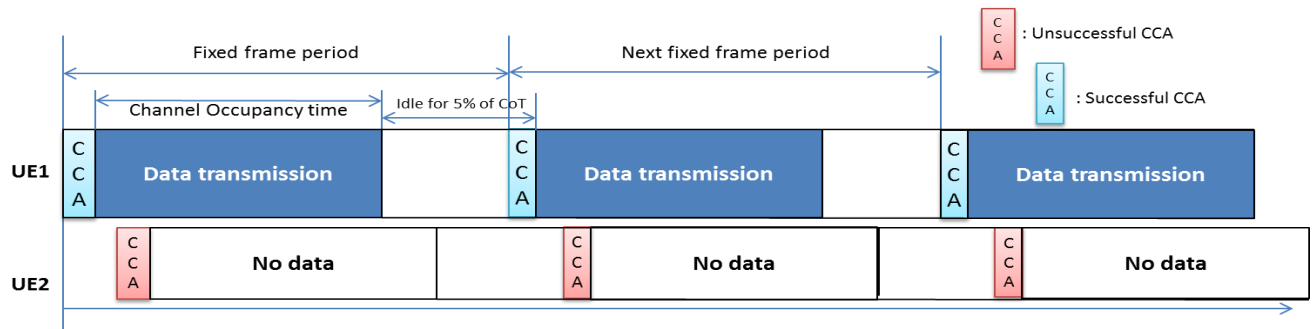

(b) Asynchronous CCA for FBE based LBT: Only UE1 transmits [15].

Figure 3.5 Synchronous and asynchronous FBE-based LBTs.

3.2.4 Implementation of the FBE-based access mechanism

In order to show the impact of FBE-based mechanisms with other access mechanisms, we implemented this scheme using the algorithm illustrated in Figure 3.6. The procedure used is briefly summarized as follows:

- Initially, CCA is applied to the channel to detect the energy level for a period equivalent to $CCA \geq 20 \mu s$.
- The channel is tested; if it is not idle; indicated by $CCA < 20 \mu s$, the equipment remain silent for whole duration of the next fixed frame, including next CCA check, otherwise, it enters the next step.
- If the channel is free; specified by the successful $CCA \geq 20 \mu s$, an equipment starts its transmission immediately and occupies the channel for a fixed CoT of 1 to 10ms depending on the frame size to be transmitted.
- Then, the equipment stays silent for a period equivalent to 5% of CoT, and applies a new CCA just at the end of 5% idle period to resume the process.

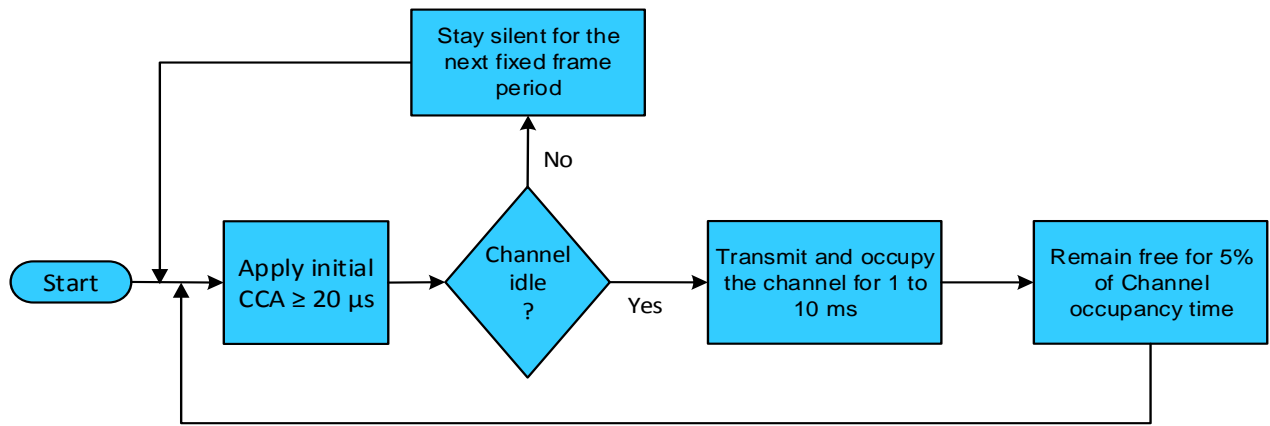

Figure 3.6 Operation mode of FBE-based LBT [14].

3.2.5 Implementation of the CSMA/CA access mechanism

In this work, we have also implemented Wi-Fi scheme; another wireless network which solely designed to operate in unlicensed band by utilization of carrier sensing to coexist with other medium access technologies or to access the shared band during the competition. As previously mentioned, this scheme utilizes CSMA/CA mechanism to detect energy level through channel sensing operation before any transmission of data packets in the shared band [30]. Similar to LAA-based mechanisms, APs or STAs use a threshold energy level, to which the detected energy is compared and then the status of the channel is reported as free or occupied by other users. In our simulation, we assumed that the channel has been idle, and we apply the initial CCA for DIFS period. But in real world and practical applications, CCA of $4 \mu\text{sec}$ should be applied. After a successful DIFS, the transmitter using Wi-Fi scheme follows the backoff mechanism to reduce collisions which may accidentally appear during co-channel competition. A transmission is immediately enabled if, after backoff (random counter $N=0$), the equipment senses that there is no one using the channel [30]. On the other hand, the transmission defers until the channel is declared as unoccupied; and the process restarts again. Figure 3.7, demonstrates the process followed during the Matlab simulation.

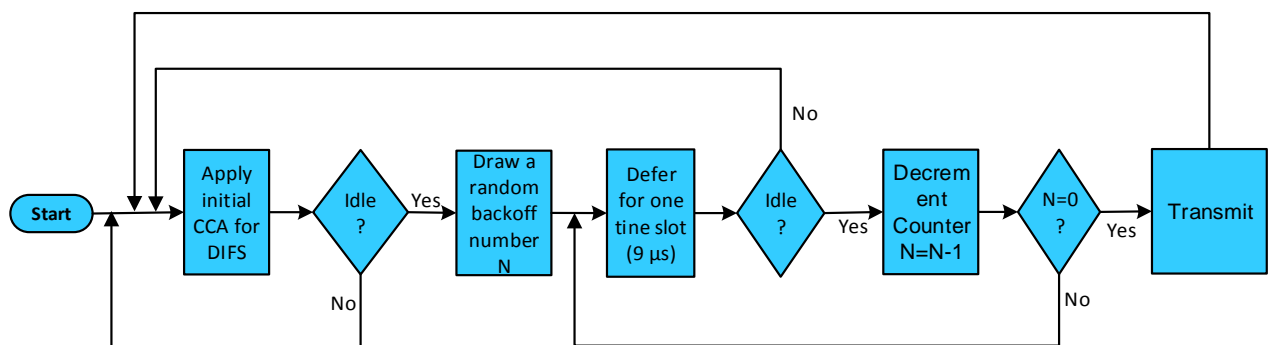

Figure 3.7 Overview of medium sensing process for Wi-Fi.

We used uniform distribution to define the random backoff number for Wi-Fi. Also, during competition, we realized that DIFS and backoff numbers have direct effect on other Wi-Fi and LAA-based LBT systems in the shared band. Therefore, DCF parameters must be designed carefully, since they may impact the overall performance of these access technologies in the shared band. For our simulation, we applied CCA for DIFS period of time equals to $34 \mu\text{s}$ while the backoff is measured in time slots with one time slot equivalent to $9 \mu\text{s}$ [30] when Wi-Fi users are operating in shared 5 GHz band. The following are the steps used to implement Wi-Fi scheme according to the algorithm in Figure 3.7.

- With the assumption that the channel has been idle, CCA is applied to the channel to detect idleness for DIFS period equivalent to $34 \mu\text{s}$.
- If the channel is idle for DIFS, a uniform random backoff number is selected. If the channel is reported as busy, CCA is applied to check again.
- The equipment defers for $9 \mu\text{s}$ while scanning the channel to check if it is idle or not. If it is deemed to be occupied, the system allows the CCA to be applied again for DIFS period; otherwise, it enters the next step.
- If the Channel is free for a duration of one time slot ($9 \mu\text{s}$), the counter N is decremented by one time slot ($N = N - 1$). If it reaches zero, the frame is transmitted immediately.
- The process is resumed by resetting the contention window to CW_{min} (15 time slots) and by applying CCA again.

For all mechanisms described above, we always assume that the data transmission is successful once the equipment has a chance to access the channel. We also assume that ACK is successful for any transmitted data. Parameters used during the simulation for both schemes are summarized in Table 3.1.

3.2.6 Implementation of hybrid access mechanism

The hybrid scheme is implemented by allowing a simultaneous competition of all equipments using either one of three schemes on the shared band. The competition follows the same process for LBE, FBE and Wi-Fi-based equipments as described above. Figure 3.8 shows the general procedure of both MAC mechanisms during channel access competition. From this figure, it can also be noted that both Wi-Fi and LBE-based schemes use random backoff counters whereas FBE-based equipment does not have it. Also, LBEs and FBEs utilize the same CCA differently while Wi-Fi utilizes CCA for DIFS period during the channel scanning.

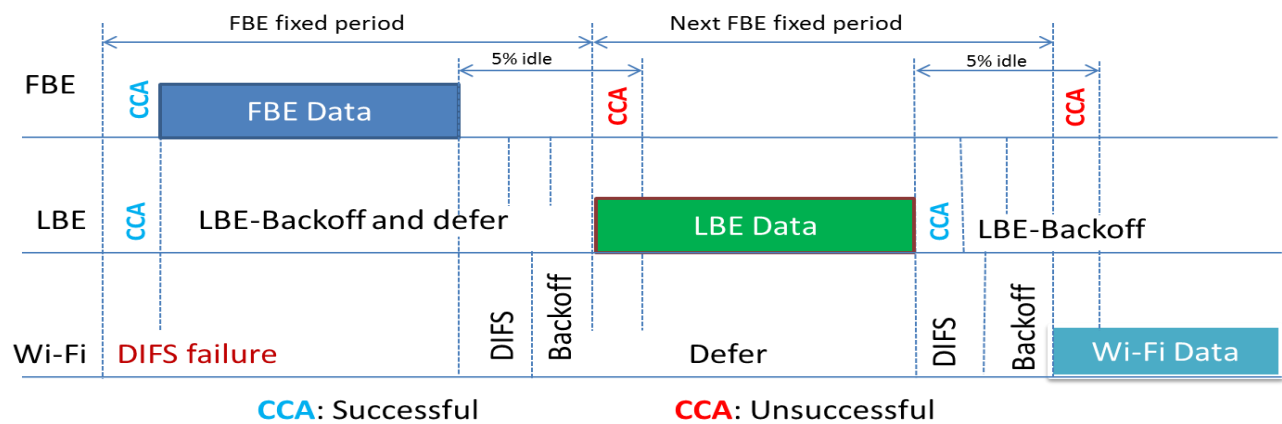

Figure 3.8 Generic procedure of shared channel access for hybrid scheme.

3.3 Enhanced FBE: the Proposed Access Mechanism and its Implementation

During simulation, we observed that some of the mechanisms present worse performance related to channel resource allocation in the shared band, while others are found impacted by them due the requirements defined by 3GPP [2] which do not meet the real world applications. Therefore, we proposed to Enhance FBE (E-FBE) mechanism, which is found to impact other schemes and LBE-based mechanism in order to reduce their effects with Wi-Fi-based scheme since it always presents poor performance because of those impacts from its competitors.

3.3.1 Principle of the E-FBE-based access mechanism

Originally, FBE was designed as a scheme having a fixed structure with fixed timing [2], even if it may change its configuration due to the idle period of 5% calculated depending on the selected CoT. However, due to the short CCA which is applied once during the channel scanning while the competition is going on, it has been shown that it is practically difficult for FBE-based equipment to compete with others in order to get the same channel opportunities. The main reason here lies on the fact that others follow CW mechanism while FBE does not have. This makes FBE to win for most of the time, while others are kept at lower level of performance. During our simulation, we introduced the new method of addressing the above stated problem which consists of letting FBE-based equipments adopt CW mechanism like LBE-based mechanism.

Since FBE is a LAA-based mechanism and may also compete with other LAA schemes, we adopt the same CW mechanism used in LBE MAC mechanism and apply it to FBE access mechanism. That is, the E-FBE-based scheme follows the same mechanism and uses the same parameters as they are used in LBE-based schemes. It will also continue to have its 5% idle period and CoT ranging from 1 to 10 ms as it is originally defined in [2]. However, the long period of waiting for the whole fixed period for an unsuccessful CCA was removed and replaced by CW length as illustrated in Figure 3.9. For the example shown in this figure, a random backoff counter N ($N = 3$ in this case) is selected from 1 to q ; where q is selected from 4 to 32. The transmission is initiated if the backoff counter $N = 0$ as previously explained, and the equipment stays silent for a period equivalent to 5% of CoT including the initial CCA for the next transmission which again followed by a new random backoff counter.

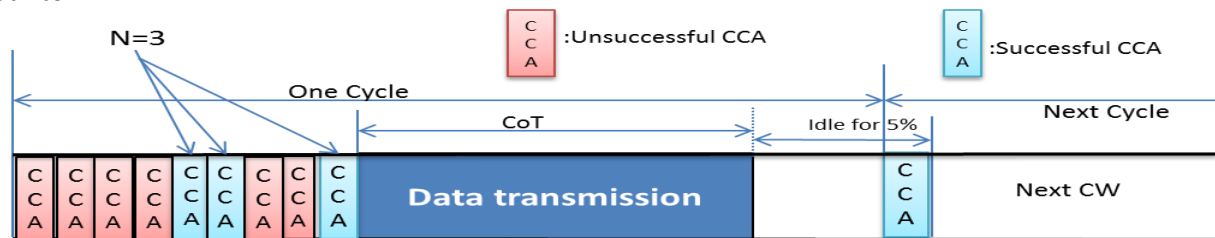

Figure 3.9 Overview of E-FBE access mechanism.

3.3.2 Implementation of the E-FBE-based access mechanism

Using Matlab simulation, we implemented E-FBE-based mechanism by following the principle explained above. Figure 3.10 illustrates the process followed during that E-FBE implementation. Same as other mechanisms considered in this work, we also used the uniform random distribution to implement this scheme and we assume the transmission to be successful once the equipment gets a chance to access the channel. The generated results related to this implementation will be later presented in Chapter 5. The following is a summary of how E-FBE-based mechanism is implemented according to the Figure 3.10.

- The simulation starts and a positive uniform random number N is selected from the range formed by interval of 1 to q ; with q being a positive integer also selected from 4 to 32.
- We apply an initial CCA for at least $20 \mu s$ to scan the channel and check its current status of idleness. Once the channel is reported as busy, we allow CCA to be applied again until the condition is fulfilled. If the channel is sensed as idle, the algorithm enters the next step.
- We let the program check if the random counter has reached zero ($N = 0$) and allow the improved FBE to immediately transmit its data packets for a fixed period ranging from 1 to 10 ms, depending on the corresponding CoT. Then it calculates the idle period of 5% of CoT which includes a new CCA to be applied again to start a new process. However, if the counter haven't yet reached zero ($N \neq 0$), the program enters the next step.

- For $N \neq 0$, a channel is scanned again for a time duration equivalent to $ECCA$ ($20 \mu s$), and if $ECCA$ is successful (i.e, $ECCA \geq 20 \mu s$), the counter N is decremented by one, and the program checks again if it has reached zero. On the other hand, if $ECCA$ is not successful ($ECCA < 20 \mu s$), the program freezes, and returns back to resume the process with a new initial CCA. The above three steps are then repeated until the transmission is successful.

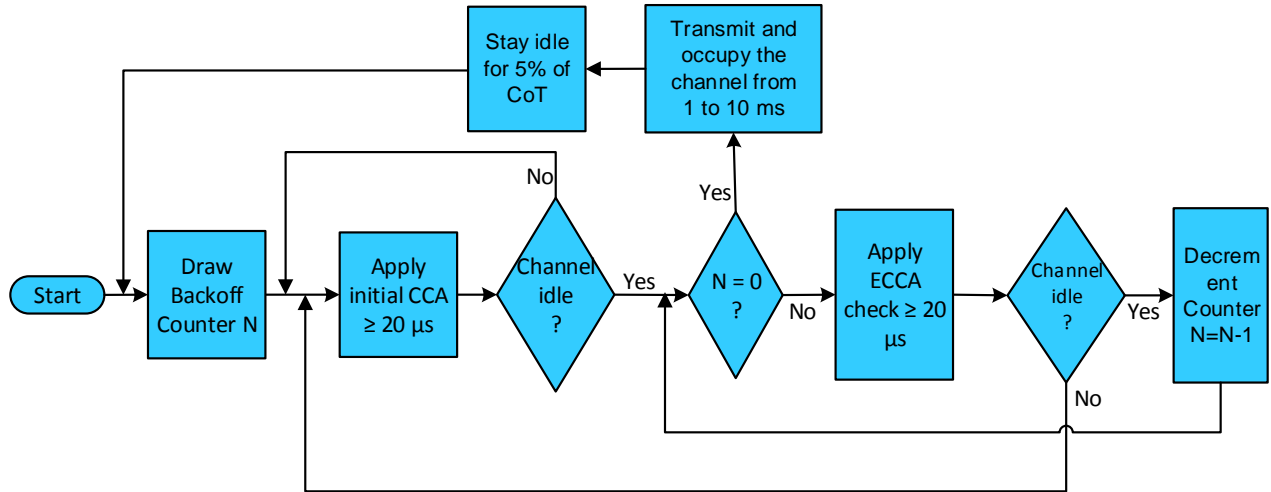

Figure 3.10 Implementation procedure of E-FBE-based LBT.

3.4 Enhanced LBE: Enlarged CW Size for LBE traffic

Having realized that the performance of both schemes has considerably increased through the application of the E-FBE-based mechanism; even in case of hybrid scenarios, we looked for other point which can further increase the performance of LBE access mechanisms to nearly 100%. As both schemes depend on CW, we introduced another new insight of extending the CW for LBE-based MAC mechanism by proposing another range of q values which yielded the best performance. We tried several q values during our simulation in order to look for the values that can generate the best performance compared to the current performance later shown in Chapter 5.

Therefore, the q values for the introduced Enhanced LBE (E-LBE) access mechanism are selected from the interval from $q = 64$ to $q = 100$. Below this range, the performance was shown as it was not intended; although it was better, while beyond this range, the performance was shown improved with almost the same results like those shown in the new proposed range (see results to be presented in Chapter 5). Throughout this simulation, we use the parameters summarized in Table 3.1 for both schemes including 3GPP and improved mechanisms.

Table 3.1 Parameters used for the performance evaluation of the LTE-U mechanisms.

Parameters	FBE	LBE	Wi-Fi	E-LBE	E-FBE
CCA (μs)	20	20	CCA as DIFS	20	20
CoT (ms)	1 to 10	1.625 to 13	0.400 to 2.400	1.625 to 13	1 to 10
Off period	5% of CoT	Depends on CW	Depends on CW	Depends on CW	5% of CoT and CW
CW	-	Extended CCA= $20 \times N$	$CW_{min} = 15$ to $CW_{max} = 1023$	Extended CCA= $20 \times N$	Extended CCA= $20 \times N$
Slot time	-	$20 \mu s$	$9 \mu s$	$20 \mu s$	$20 \mu s$
DIFS	-	-	$34 \mu s$	-	-
q range	-	4 to 32	-	64 to 100	4 to 32

3.5 Chapter Summary

In this chapter, we explained the principle and implementation of LTE-U access mechanism including both 3GPP and the new proposed schemes. As it is explained above, both LAA-based mechanisms proposed by 3GPP apply CCA for the same duration ($CCA \geq 20 \mu s$), but in a different way; i.e, FBE-based equipment senses the channel for CCA period and transmits immediately upon successful CCA while LBE-based equipment follows the linear backoff mechanism, where it is allowed to transmit if the selected backoff counter reaches zero, otherwise it freezes. Also, Wi-Fi based equipment follows exponential backoff mechanism through the CSMA/CA adaptation.

However, the Matlab simulation shows that FBE-based scheme can always perform better than others during competition. And this is because of the CCA which is applied once for deciding the transmission, while LBE-based and Wi-Fi are still sensing. Therefore, to overcome this challenge, we proposed E-FBE which consists of inserting backoff mechanism. To increase the performance, we also proposed E-LBE which consists of defining a new range from which q parameter is selected. Hence, with these new insights, we are convinced that these two enhanced schemes can give better performance even in hybrid scenarios as shown by results presented hereafter in Chapters 4 and 5.

4 Performance Evaluation of LAA-based LBT Access Mechanisms

From the above discussions, we now present the results generated based on the above simulation descriptions and assumptions of both mechanisms proposed by 3GPP such as LBE and FBE as well as Wi-Fi-based mechanisms. This assessment of results is done in order to achieve better fairness and friendly coexistence with other LAA and Wi-Fi based systems in the shared band. Therefore, we present the performance results in terms access opportunities to the channel acquired by each scheme during the competition. Since, the simulation is based on multi-competition scenarios, we show this performance by exploiting Jain's fairness index, and investigate the percentage of fairness of both schemes; either between pairs of users competing for accessing the channel or between multi-user (or hybrid) competitions.

Through the considered multi-trial competitions for different users, we extended Jain's fairness formula shown in Equation (2.1) that originally takes into account the number of users to Equation (4.1). The newly extended Equation (4.1) considers both number of users and the number of competitions attempted by the user respectively. This formula is applied to all mechanisms presented here in this thesis work.

$$I_{Tot} = \frac{1}{M} \times \sum_{j=1}^M FI_j \quad (4.1)$$

where I_{Tot} is Jain's fairness index for all considered competitions in a given range. FI indicates the individual fairness index of n users evaluated for 10 trials ($M=1$) and calculated using Equation (2.1); and M is the number of variable parameters (or number of indices) along the considered range. Therefore, for every M parameter (or every FI), we have 10 competitions. This also indicates the variability of the individual FI calculated for any given individual frame size (or transmission time). We extended this formula because we have to calculate the average fairness for 10 competitions considered for a given range of parameters (M) and for a given scenario through Matlab simulation.

4.1 Scenarios and Evaluation Parameters

The results generated are based on two-equipment combinations (or pairs) where two selected equipments compete for the channel access, and hybrid combination combining all three schemes. Combinations and scenarios considered in this evaluation are shown in Table 4.1. For each combination, we vary the corresponding parameters depending on the mechanisms under considerations. For example, in the hybrid mechanism, we consider that all three LTE-U-based mechanisms are simultaneously competing for accessing the channel. Therefore, we will determine the access possibilities of every scheme on the channel which are determined in terms of number of access opportunities by varying either the backoff scaler q_1 for LBE, CoT for FBE or TxWiFi for Wi-Fi.

Table 4.1 Scenarios and parameters used for evaluating the LAA-based mechanisms.

Scenarios	MAC mechanisms	Combinations	Variable parameters	Performance parameters
Scenario 1	LBE-based mechanisms	LBE1+LBE2	q_1 for LBE1	FI and channel access opportunities
		LBE+FBE	q_1 for LBE	
			CoT for FBE	
LBE+Wi-Fi	q_1 for FBE			
	TxWiFi for Wi-Fi			
Scenario 2	FBE-based mechanisms	FBE1+FBE2	CoT for FBE1	
		FBE+Wi-Fi	CoT for FBE	
			TxWiFi for Wi-Fi	
Scenario 3	Hybrid mechanisms	LBE+FBE+Wi-Fi	q_1 for LBE	
			CoT for FBE	
			TxWiFi for Wi-Fi	

Similarly, having determined those access opportunities, we do the general assessment and we evaluate fairness of the whole combination by determining the FI between the concerned schemes using Equation (4.1). This also is done through the variation of one of the parameters q_1 , CoT and TxWiFi for LBE, FBE and Wi-Fi-based mechanisms respectively. This parameter variation also reflects the variation of frame size for the corresponding mechanism. Under these considerations, we then evaluate the performance of every combination shown in Table 4.1 and present results herein the next sections. However, due to the presentation priority, we postpone some of the results to the appendices.

4.2 Scenario 1: Numerical Results of LBE-based MAC Mechanisms

One of the pairs considered for LTE-U based mechanisms of scenario 1 is the combination of LBE-based scheme with other schemes using FBE or Wi-Fi based systems. In our simulation, various CoTs and Wi-Fi transmission times (TxWiFi) were used and made variable in some cases in order to observe the behaviours of their corresponding mechanisms during competitions; and thereafter evaluate the possibilities of fairness which gives the general picture of efficient coexistence between them once deployed in the shared 5 GHz band. We varied the transmission time in order to be consistent with proposed 3GPP requirement for adaptive transmission for LBE-based schemes.

4.2.1 LBE1 and LBE2-based combination with variable backoff scaler (q_1)

A pair of two LBE-based equipments is firstly evaluated in our simulation. Throughout this discussion, we will denote those equipments by LBE1 and LBE2 respectively. We also consider that both two equipments competing for channel access use LTE systems and are both based on backoff mechanisms described in the above sections. Several runs are made in order to check for their fairness on channel access. We fix one LBE-based equipment at different values of q_2 while q_1 parameter of another equipment is kept variable from $q_1 = 4$ to $q_1 = 32$. According to Equation (3.1), these values of q_1 and q_2 reflect the variation of CoT, CWs as well as frame size variation for both equipments. Generally, the results for this scenario, show that the fairness increases as the variable q_1 of LBE1 gets closer to the fixed value of $q_2=32$ of LBE2. That is, after the equipment is allowed to occupy the channel because of the followed backoff algorithm explained above, and if the value of q_2 is large; this gives a long range of CW from which the backoff counter (N) is selected. This opens enough free space for other competitors (LBE1) to access the channel. Moreover, if frame sizes of both LBEs in competition are approximately equal, the fairness is also shown to be the best since both equipments adopt CSMA mechanism. It is again important to note that N is selected from 1 to the fixed q values ($N \in [1, q]$). Results shown in Figure 4.1 illustrate the fairness of this scenario under these considerations at $q_2=4$, $q_2=17$ and $q_2=32$ respectively with variable q_1 .

As mentioned above, our simulation is based on multi-trial competitions. We allow equipments competing for 10 times following CSMA mechanisms described above. And then we calculate how many times LBE2 and LBE1 have been allowed to occupy the channel. Therefore, as shown in Figure 4.1c and in Table 4.2, the fairness becomes better and better as q_1 gets closer to $q_2=32$; since there is a larger CW for both LBEs to select random backoff counter and their frame sizes are also approximately close to each other. This will allow them to almost have the same opportunities to access the channel as it the case for $q_1=27$ to $q_1=32$; where both LBEs occupy the channel for 5 times each. At q_2 close to the minimum values of q_1 ($q_1 = 4$), LBE2 is suffered. And this is because the CW for LBE1 is very short while that of LBE2 is wide. And it is very easy for LBE1 having shorter q_1 to select a smaller N while it is likely difficult for LBE2 having large q_2 to select a shorter backoff counter N . As a result, LBE1 always occupies the channel as shown in the same figure and table at $q_1=4$ to $q_1=8$ and so on. Similar results are shown at a fixed $q_2=4$; where both LBEs are found to also have nearly equal opportunities for q_1 values close to $q_2=4$. Again, LBE1 is starved for q_1 values close to 32, since LBE2 will have the shortest CW length from where the counter N is selected. These results are shown in Appendix A.1.

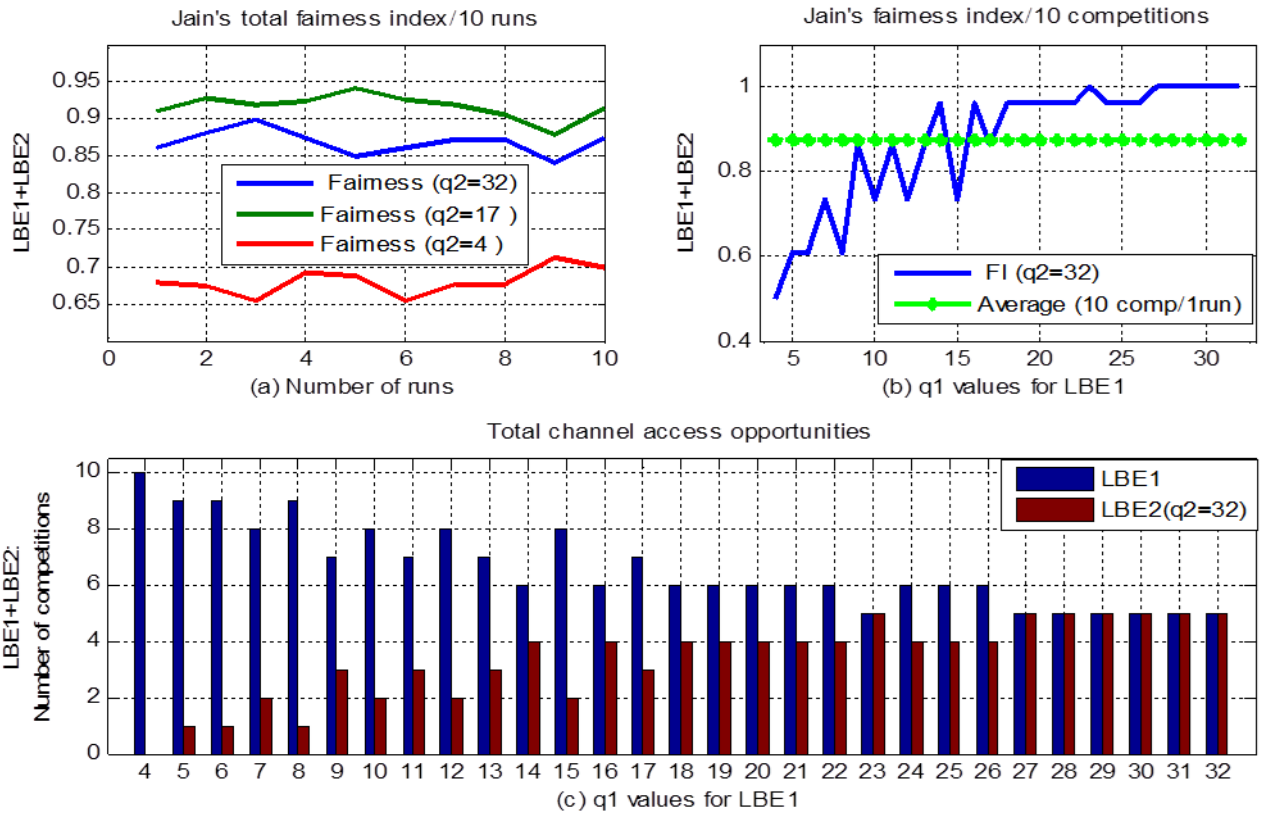

Figure 4.1 Fairness for LBE1+LBE2 with variable backoff scaler

At $q_2=17$ which is almost in the middle of the range of backoff scaler q_1 , channel opportunities are concentrated in the middle whereas LBE1 is shown with less number of channel access opportunities at the values of q_2 close to $q_1=4$ and $q_1=32$ than for the middle values. Since the approach is the same as that shown at $q_2=32$ above, we do not show results for channel opportunities here, rather; we show how these opportunities vary in terms of Jain's FI together with the case of $q_2=32$ and $q_2=4$ in Figure 4.1a. The FI is calculated using Equation (4.1) and is considered for 10 trials at every q_1 position of Figure 4.1c. The calculation also takes into account the number of users which are two ($n = 2$) in this case at any q values. Here M corresponds to the number of LBEs which takes different values of q_1 , i.e, $M = 29$ in this case.

The FI calculation is done at any of q_1 values; meaning that we have M indices which further are averaged to check the behaviours of the whole system in terms of FI. And this gives a general picture about the overall fairness index between LBE-based equipments under considerations. Figure 4.1b shows the variation of fairness between LBE2 at the fixed $q_2=32$ and LBE1 with variable q_1 . The same figure shows also the average FI of this pair under similar conditions. Similar to above discussion about opportunities, the fairness is also shown to increase as q_1 gets closer to 32. For this results LBE1 and LBE2 have equal opportunities to the channel at $q_1=27$ to $q_1=32$; hence the FI increases to 100%. The worse case appears at $q_1=4$, where the $FI = 50\%$. The Average FI for one run is evaluated at $FI = 87.36\%$ while it increased to $FI=87.81\%$ for 10 runs at $q_2=32$.

As we are showing the results at $q_2=4$, 17 and 32, we also calculate the corresponding average FI for both cases at one run and run again for 10 times (10 runs). The results for these 10 runs are shown in Figure 4.1a and they reflect the same observations; i.e, as q_1 increases, fairness also increases. However, from the same figure, FI at $q_1 = 17$ is shown to be larger because $q_1=17$ is almost in the middle of the whole range considered for q_1 , which increases the fairness around it. As explained above, the main reason lies in the CWs of both LBEs for q_1 and q_2 values which tend to be balanced and allow the equipments using q values close to the middle to select random N from approximately the same range. Note also that, equipments using q values close to the middle, can likely transmits with almost equal CoTs. Table 4.2 shows FI and access opportunities of both LBEs when $q_2 = 32$.

Table 4.2 FI indices and channel access opportunities for two LBEs ($q_2=32$).

q1 values	4	5	6	7	8	9	10	11	12	13	14	15	16	17	18
LBE1	10	9	9	8	9	7	8	7	8	7	6	8	6	7	6
LBE2	0	1	1	2	1	3	2	3	2	3	4	2	4	3	4
FI_index	0.5	0.61	0.61	0.735	0.61	0.862	0.735	0.862	0.735	0.862	0.962	0.735	0.96	0.86	0.962
q1 values	19	20	21	22	23	24	25	26	27	28	29	30	31	32	
LBE1	6	6	6	6	5	6	6	6	5	5	5	5	5	5	
LBE2	4	4	4	4	5	4	4	4	5	5	5	5	5	5	
FI index	0.962	0.962	0.962	0.962	1	0.962	0.962	0.962	1	1	1	1	1	1	
Average /10 Competitions													0.8736		
Average /10 runs													0.8781		

4.2.2 LBE and Wi-Fi-based combination with variable Wi-Fi transmission time

Another evaluated pair of equipments is a combination of Wi-Fi and LBE competing for accessing the channel. Here, we consider the variation of Wi-Fi transmission time from 400 μ s to 2400 μ s and different fixed q_1 values for LBE-based equipment. In other words, we vary the frame size for Wi-Fi and fix the frame size for LBE which may be derived from Equation (3.1) for a given data rate, and the values of q_1 also fixed at $q_1=4, 18$ and 32. Similar to above discussion, we also allow these two schemes compete for 10 times and assess how many times each of them has accessed the channels. It is also of paramount importance to note that both two schemes follow the backoff mechanism where LBE backoff counter $N \in [1, q]$ and Wi-Fi follows exponential backoff with $CW_{min} = 15$.

The general evaluation of results under these considerations shows that as q_1 increases, both LBE and Wi-Fi equipment tends to have equal opportunities on the channel as shown in Figure 4.2c. This can also be explained by the increase of LBE CW and the selected random counter. That is, as q_1 is larger, it is likely for LBE to also select a larger backoff counter (N) since the range for its CW also gets larger depending on the selected counter N ; hence Wi-Fi can take advantages and transmits within that long CW. Also, since Wi-Fi adopts exponential backoff mechanism, it can choose a shorter random counter which may expire first to confirm the access to the channel. This is illustrated in Figure 4.2c and shown in Table 4.3 for $TxWiFi = 2400 \mu$ s where both schemes get equal share of access opportunities equivalent to 5 times each. There is an imbalance of channel opportunities at $TxWiFi$ close to 400 μ s because of large q_1 values which reflects the long CoT for LBE. That is, once LBE occupies the channel, it keeps it for long time as well as it has larger frame size. The following table shows the distribution of channel opportunities for both Wi-Fi and LBE based schemes. It also shows the evaluated FI between them as it is explained hereafter.

Table 4.3 Numerical results for FI between LBE and Wi-Fi ($q_1=32$).

TxWiFi	400	600	800	1000	1200	1400	1600	1800	2000	2200
LBE	8	3	9	9	6	2	6	8	6	5
Wi-Fi	2	7	1	1	4	8	4	2	4	5
FI index	0.735	0.862	0.61	0.61	0.962	0.735	0.962	0.735	0.962	1
Average /10 Competitions									0.8142	
Average /10 runs									0.8278	

The same results are also reflected by the Figure 4.2b, where we determine FI for the whole system for one run. This figure shows that FI increases with the increase of $TxWiFi$. However, the decision for this observation is taken by the parameter q_1 of LBE scheme. Therefore, we consider the average FI in this case. Here, the simulation is done at $q_1=32$ and the average FI for one run is calculated as

$FI = 81.42\%$. To confirm this general conclusion, we extended this simulation to 10 runs with different q_1 values fixed at $q_1=4, 18$ and 32 . And as shown in Figure 4.2a, the total average FI for 10 run is elevated from 66.32% , 76.23% and 82.78% calculated at $q_1=4, 18$ and 32 respectively. Hence, we can conclude that LBE and Wi-Fi can get almost equal opportunities as q_1 increases when $TxWiFi$ is made variable.

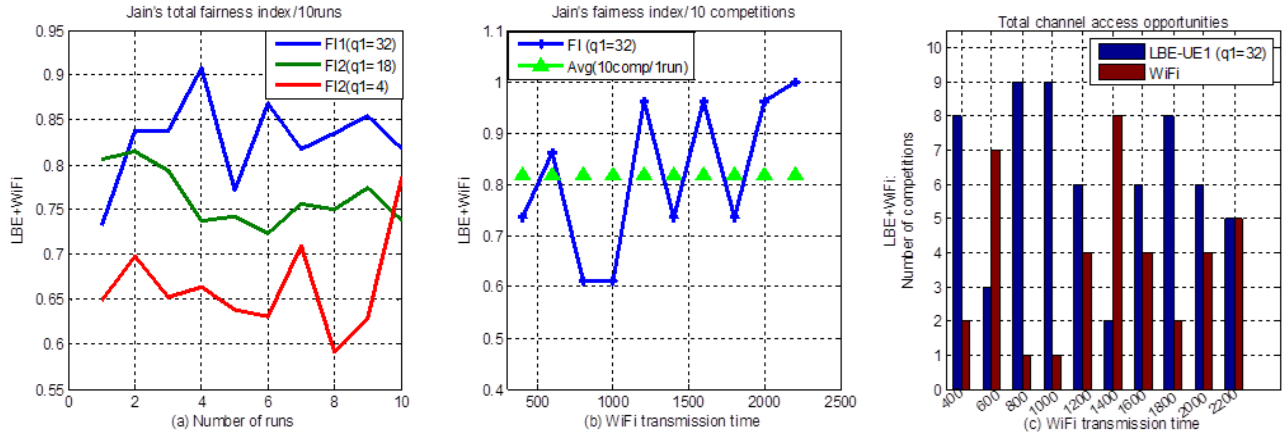

Figure 4.2 FI and access opportunities for LBE+Wi-Fi with variable transmission time.

During our Matlab simulation, we also considered another LBE and Wi-Fi combination where the backoff sclaler q_1 of LBE is made variable from $q_1=4$ to $q_1=32$, with fixed Wi-Fi transmission time at $TxWiFi = 400 \mu s$, $TxWiFi = 800 \mu s$ and $TxWiFi = 1000 \mu s$. In both cases, the results demonstrate that the average FI varies between 75% to 77% and these averages are approximated to the $FI = 76\%$ calculated at $TxWiFi = 400 \mu s$ for one run, i.e, average FI is always bounded to around $FI = 76\%$. However, in both cases LBE always gets more opportunities than Wi-Fi. This indicates that the variation of $TxWiFi$ has no impact on the general observation for this combination. Results for this combination are found in Appendix A.2.

4.2.3 LBE and FBE-based combination with variable channel occupancy time

The remaining combination for scenario 1 considered in our simulation is the combination of LBE and FBE equipments. As discussed above, the principle of LBE is based on CSMA adopting CW mechanism. However, FBE does not follow any of the mechanisms using CW. For this combination, we have two different cases described as follows:

Case one: this case consists of LBE fixed at $q_1=4, 18$ and 32 with variable of FBE's CoT from $1000 \mu s$ to $10000 \mu s$. In all cases where FBE is applied, it is important to be reminded that FBE stays silent for 5% of its CoT after a successful transmission and during the whole next fixed period if the transmission is unsuccessful. Therefore, since both LBE and FBE apply initial CCA for sensing the channel idleness, LBE will have more opportunities for channel access in that 5% and in the idle fixed period of failure transmission. Alternatively, FBE takes more advantages in a long CW of LBE schemes. Note also that LBE has to follow CSMA to draw random backoff counter. We therefore take into account the described parameters to explain our simulation results under different cases.

The evaluation of results for the scheme described in the previous paragraph is shown in Figure 4.3. Similar to above cases, results are shown in terms of channel access opportunities and FIs for the whole system. This FI is calculated using Equation (4.1) for two users such as LBE and FBE-based equipments ($n = 2$) at every individual CoT. It is afterall extended to $M = 10$ corresponding to the number of CoT variations (i.e FI for M counts). Regarding channel access opportunities, we solely show them at $q_1 = 4$ for LBE and let FBE CoTs vary from $1000 \mu s$ to $10000 \mu s$. Considering CW, LBE will select backoff counter N from 1 to $q_1 = 4$ in which FBE will apply its CCA. Since this CW range is very short, it is likely possible for LBE to take advantages of the idle periods for FBE as the

selected N will also likely be shorter although FBE has more chances to transmit upon successful CCA sensing period. This results in almost better distribution of channel opportunities. Although FBE is always given high priority because of its CCA which is applied once, there are some cases where both are shown with equal opportunities of 5 times each, namely at $CoT = 3000 \mu s$, $CoT = 7000 \mu s$ and at $CoT = 10000 \mu s$ as illustrated in Figure 4.3c and shown in Table 4.4. But this does not happen always, since N is random. However, there are cases which are shown with equal opportunities at every run, not necessarily at the stated CoTs.

Table 4.4 Results for FI between LBE and FBE with variable channel occupancy time ($q_1=4$).

CoT	1000	2000	3000	4000	5000	6000	7000	8000	9000	10000
LBE	4	3	5	2	3	2	5	2	3	5
FBE	6	7	5	8	7	8	5	8	7	5
FI index	0.962	0.862	1	0.735	0.862	0.735	1	0.735	0.862	1
Average /10 Competitions									0.8754	
Average /10 runs									0.9212	

We generalize this observation by FI calculation at $q_1 = 4$ where the average FI for one run is calculated as 87.54%; meaning that this scheme is fair at $q_1=4$ as shown in Figure 4.3c although FBE has more chances because of the same reasons explained above. We again extend this scenario by running it for other 10 times and show how fair this scheme is at $q_1 = 18$ and $q_1 = 32$ compared to $q_1 = 4$. The calculated average FIs are 53.34% at $q_1 = 32$, 57.18% at $q_1 = 18$ and FI is boosted to 92.12% at $q_1 = 4$. Indicating that the average FI degrades as q_1 increases because of the same reason explained above. These results are illustrated in Figure 4.3a.

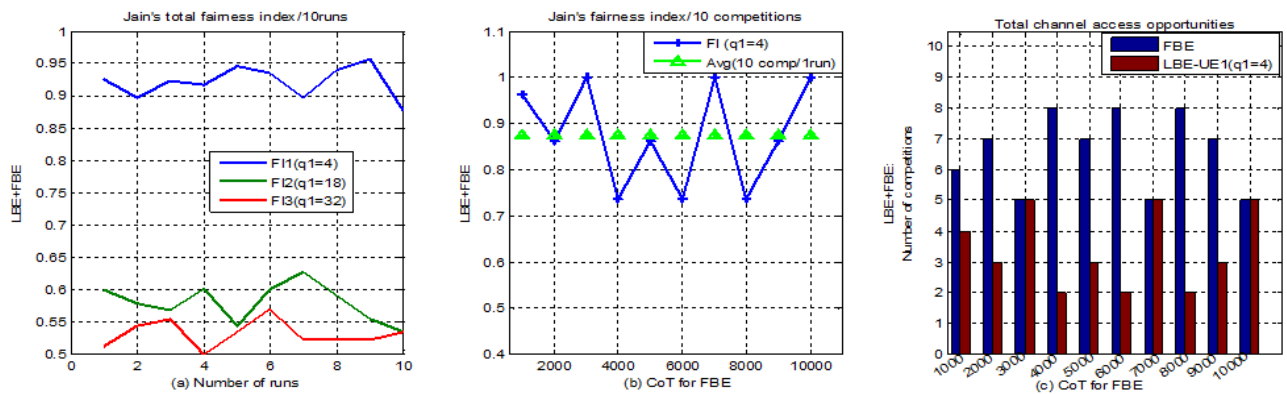

Figure 4. 3 Channel opportunities and FI for LBE+FBE with variable channel occupancy time.

Case two: another case of LBE and FBE-based equipments is considered by varying q_1 parameter for LBE and fix CoTs for FBE to $CoT = 1000 \mu s$, $CoT = 5000 \mu s$ and $CoT = 10000 \mu s$. We follow the same evaluation procedure during our Matlab simulation. Results of this combination are found in Appendix A.3. However, in general, this scheme demonstrates the poor performance where; in both cases, the average FIs vary from 61.56% for $CoT = 10000 \mu s$, 61.86% for $CoT = 5000 \mu s$ to 62.24% for $CoT = 1000 \mu s$. This means that the average FI remains bounded around the average FI of 62.24% calculated at $CoT = 1000 \mu s$ for one run. Therefore, the general observation of these results indicates that the FI is not affected with any variation of CoTs. According to the results, FI is increased for q_1 values close to 4 because it is at this value where the LBE CW is minimum and can take advantage to transmit in the idle periods of FBE. There, LBE-based equipment may likely select shorter backoff number.

4.3 Scenario 2: Numerical Results of FBE-based MAC Mechanism

FBE can compete with other LAA-based schemes such as LBEs and other FBEs as well as Wi-Fi for equipments deployed in the shared band. In this scenario 2, we present only the results of FBE combination with Wi-Fi as well as other FBE-based mechanisms since other combinations are already presented above together with LBE pairs.

4.3.1 FBE and other FBE-based combination

FBE-based equipments competing with other FBEs has been shown to be problematic for implementation purpose. As previously mentioned, if FBEs are competing for accessing the channel, they result in collisions if they are synchronized. Also, if these equipments are made asynchronous, the equipment which grabbed the channel for the first time will always transmit while others are completely starved [15], because they simultaneously apply the same initial CCA for sensing the channel idleness as previously illustrated in Figure 3.5. Here, we do not show results for the synchronous FBE combinations. Rather, we only mention the results of asynchronous FBEs, where two FBE-based equipments (FBE1 and FBE2) compete for accessing the channel. However, only FBE1 is shown with maximum opportunities while FBE2 is completely starved (with zero chance). By calculating FI of this combination, we observe that the average FI remains at 50% for both single and 10 runs. These results are shown in Appendix A.4. For the sake of efficient coexistence, we further propose the ameliorated scheme presented in Chapter 5, towards the improvement of fairness between other FBE-based combinations as well as other access mechanisms.

4.3.2 FBE and Wi-Fi-based mechanism with variable Wi-Fi transmission time

In this combination, we conducted the simulation and display results for FBE competing with Wi-Fi based access mechanisms. We considered two schemes for this combination. For the first one, we fix FBE's CoT at $CoT = 1000 \mu s$, $CoT = 5000 \mu s$ and $CoT = 10000 \mu s$ and let the transmission time for Wi-Fi vary from $400 \mu s$ to $2400 \mu s$. Since Wi-Fi follows the backoff mechanism, it has been shown that, while Wi-Fi keeps on decrementing its backoff number, FBE grabs the channel and transmits, because it applies its CCA for one time and decides its data transmission accordingly. And if CCA is successful, FBE immediately sends its frame. Note also that we use CCA for $DIFS = 34 \mu s$ and $9 \mu s$ for one time slot, which makes a total waiting time of $43 \mu s$ for Wi-Fi to transmit if its selected backoff counter $N = 1$; while $CCA = 20 \mu s$ for FBE. This means that FBE may transmit 2 times before Wi-Fi is allowed to transmit. Since N is random for Wi-Fi, this leads to large number of access opportunities for FBE than Wi-Fi-based schemes. The following table shows the numerical results for this FBE pair.

Table 4.5 Numerical results showing FI for FBE+Wi-Fi with variable Wi-Fi transmission time

TxWi-Fi	400	600	800	1000	1200	1400	1600	1800	2000	2200	2400
FBE	10	8	10	7	10	9	8	10	8	9	10
Wi-Fi	0	3	0	3	0	1	3	0	4	0	0
FI index	0.5	0.829	0.5	0.862	0.5	0.61	0.829	0.5	0.9	0.5	0.5
Average /10 Competitions									0.639		
Average /10 runs									0.6566		

The results shown in terms of channel opportunities illustrated in Figure 4.4c and in Table 4.5 indicate that always FBE has more chance compared with Wi-Fi scheme. For our simulation, we let these equipments compete for 10 trials and evaluate how many times one of them has access to the channel. The figure shows that always Wi-Fi is kept at lower level and it may also happen that it is completely starved as it is the case for $TxWi-Fi = 400 \mu s$ and $TxWi-Fi = 800 \mu s$ and so on. We evaluate FI to check how fair this scheme is when FBE $CoT = 1000 \mu s$ for only one run as shown in

Figure 4.4b. By assessing the results for different runs, we observe that the average FIs oscillates between 62% to 79% which are around the average FI of 63.9% calculated at $CoT = 1000 \mu s$. We extend this FI calculation to 10 runs at different CoT values, and the results reflect the same conclusion. Figure 4.4a depicts this consideration and it is shown that the averages of FI are computed as 65.53%, 65.66% and 66.47% CoT evaluated at $CoT = 1000 \mu s$, $CoT = 5000 \mu s$ and $CoT = 10000 \mu s$ respectively. Again, the average FI is found to oscillate around 65.66% calculated at $CoT = 1000 \mu s$ for 10 runs.

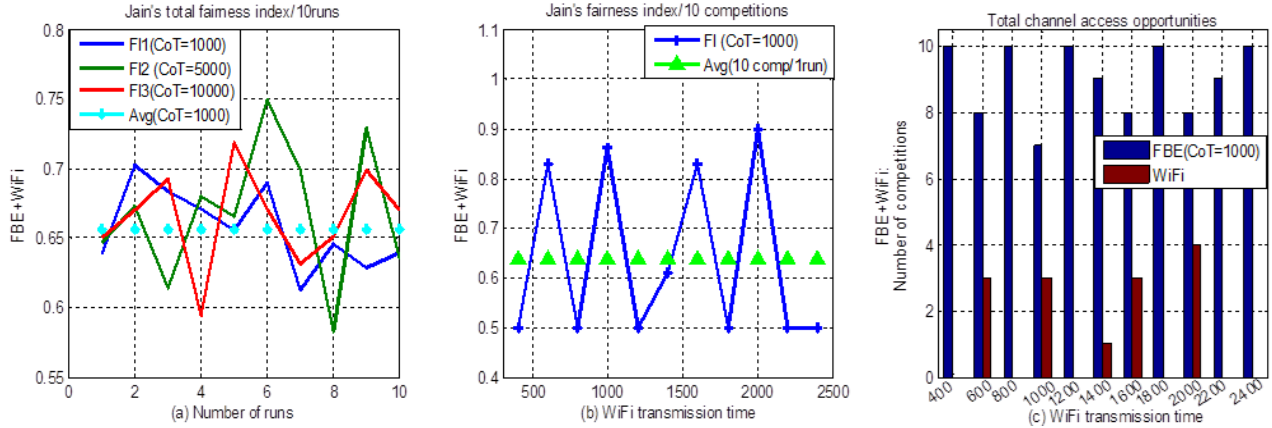

Figure 4.4 Channel opportunities and FI for FBE+Wi-Fi with variable Wi-Fi transmission time.

4.3.3 FBE and Wi-Fi-based mechanism with variable channel occupancy time

The second FBE combination is evaluated at variable $CoTs$ from $1000 \mu s$ to $10000 \mu s$ with Wi-Fi transmission time fixed at $TxWiFi = 400 \mu s$, $TxWiFi = 800 \mu s$ and $TxWiFi = 1000 \mu s$. And in general, we realized similar observations as in the case of FBE and Wi-Fi combination with $TxWiFi$ variable presented above. But in this case, the average FI is found balancing between 64% to 77% for several runs. However, the average FI was computed as 66.01% and 66.56% for one run and 10 runs for both cases when they are evaluated at $TxWiFi = 400 \mu s$ respectively. Regarding channel opportunities, results show that Wi-Fi opportunities are considerably degraded due to the same reasons previously explained. Results for this scenario are shown in Appendix A.5.

4.4 Scenario 3: Numerical Results for LAA-based LBT in Hybrid Scenario

The evaluation of hybrid scenario is based on assessing the channel resource allocation among LBE, FBE and Wi-Fi based equipments competing for accessing the channel simultaneously. We also perform these assessment by allowing involved parameters to change in the considered ranges while fix some of them at certain values as it detailed here in the following discussions.

4.4.1 Hybrid scenario with variable backoff scaler

In this hybrid combination, we evaluate the results got from Matlab simulation, by allowing the values of backoff scaler $q1$ for LBE-based equipment to change from 4 to 32. Since we have three schemes in this combination, we also consider two cases as it is explained below.

Cases one: one case consists of fixing Wi-Fi transmission time at $TxWiFi = 400 \mu s$, $800 \mu s$ and $1000 \mu s$, and at the same time, we fix CoT for FBE at $CoT = 1000 \mu s$. Then, we vary $q1$ parameter of LBE in the given range (from $q1 = 4$ to $q1 = 32$). Through Matlab simulation, we observed that the results of these two cases are quite the same. The results of this first case are illustrated in Figure 4.5 and shown in Table 4.6 here in this discussion. Regarding, the number of channel access opportunities shown in Figure 4.5c, FBE-based equipment is shown with more chances on the shared channel than others throughout the whole range of $q1$ values. As explained above, both Wi-Fi

and LBEs use the concept of CW by drawing their random backoff counters. Therefore, FBE based equipments take advantage of that CW for both LBE and Wi-Fi schemes. Note also that the initial CCA for FBE is applied only once to decide the transmission while other competitors are waiting to decrement their backoff counters. This yields the higher number of channel opportunities for FBE as shown in Figure 4.5. On the other hand, LBE and Wi-Fi get chances in the long idle periods of FBE such as 5% of CoT and the whole fixed frame period if there is no FBE transmission.

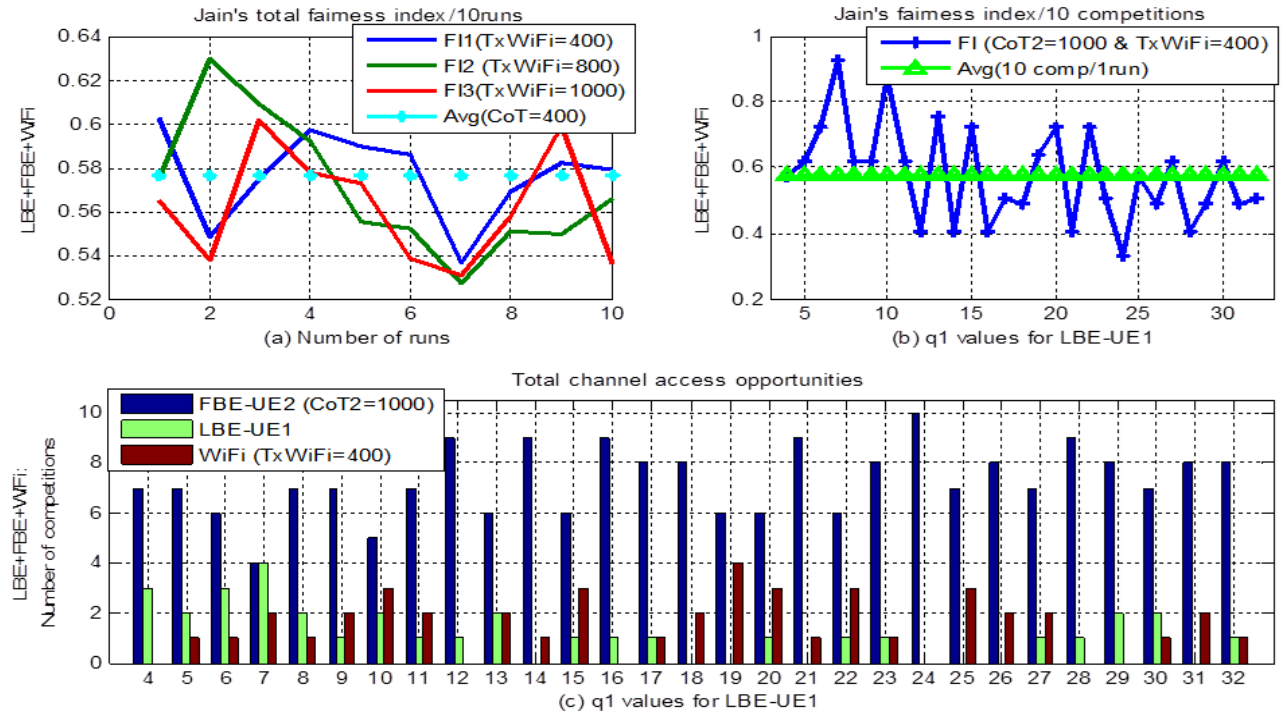

Figure 4.5 Access opportunities & FI in hybrid scenario with variable backoff scaler (case one).

The results of this combination is also evaluated by considering the Jain's FI calculated for one run at $TxWiFi = 400 \mu s$ and $CoT = 1000 \mu s$ for FBE as illustrated in Figure 4.5b. The assessment of results indicates that the FI oscillates around the average of 57.91%. These three schemes could be considered as fair if one of them gets opportunities by 33.33%, which could have boosted the overall FI to almost 100%. However, the overall average FI is 57.91% for three users because FBE-based equipment gets more chances than others for reasons explained above. Furthermore, the simulation is then run for 10 times to check the variation of FI for several runs and at different fixed Wi-Fi transmissions (indicating different frame lengths). But in general, we observed the results which reflect the same conclusion as above. That is, the average FI s oscillate between 51% and 69%. And this is also indicated by the average FI s shown in Figure 4.5a calculated at 57.67%, 57.07% and 56.17% when Wi-Fi transmissions are fixed to $TxWiFi = 400 \mu s$, $TxWiFi = 400 \mu s$ and $TxWiFi = 400 \mu s$ respectively. Note also that these results are generated by letting $q1$ parameter of LBE-based schemes as a variable.

Case two: another case for this combination is evaluated by choosing different values of CoT for FBE and fix them at $CoT=1000 \mu s$, $5000 \mu s$, and $1000 \mu s$ while letting $TxWiFi$ fixed at $400 \mu s$. Again, we vary the backoff scaler $q1$ for LBE. We assessed the results of this case and found also that they again reflect the same conclusion under the same conditions as described above; i.e, always the overall FI s balances between 51% and 69%, because FBE-based equipment is always the winner. The reasons for this conclusion are also the same as described above. Since, these two cases show results leading to the same conclusion; we only show here the results of the first whose results are illustrated in Figure 4.5 and shown in Table 4.6.

Table 4.6 Numerical results of the hybrid scenario with variable backoff scaler q1 (case one).

q1 values	4	5	6	7	8	9	10	11	12	13	14	15	16	17	18
LBE	3	2	3	4	2	1	2	1	1	2	0	1	1	1	0
FBE	7	7	6	4	7	7	5	7	9	6	9	6	9	8	8
Wi-Fi	0	1	1	2	1	2	3	2	0	2	1	3	0	1	2
FI_index	0.57	0.62	0.72	0.93	0.62	0.62	0.88	0.62	0.41	0.76	0.41	0.72	0.41	0.51	0.49
q1 values	19	20	21	22	23	24	25	26	27	28	29	30	31	32	
LBE	0	1	0	1	1	0	0	0	1	1	2	2	0	1	
FBE	6	6	9	6	8	10	7	8	7	9	8	7	8	8	
Wi-Fi	4	3	1	3	1	0	3	2	2	0	0	1	2	1	
FI index	0.64	0.72	0.41	0.72	0.51	0.33	0.57	0.49	0.62	0.41	0.49	0.62	0.49	0.51	
Average /10 Competitions													0.5791		
Average /10 runs													0.5767		

4.4.2 Hybrid scenario with variable Wi-Fi transmission time

For the simulation of hybrid scenarios, we also considered the case where Wi-Fi transmission time is made variable. We conducted different runs by considering various cases. However, we only present here in this thesis the results of two cases evaluated differently for some selected *CoT*s of FBE and q1 of LBE-based schemes separately.

Case one: this case consists of results generated at some fixed q1 values such as q1=4, 18 and 32 respectively while keeping Wi-Fi transmission time variable. As described in the previous sections, q1 values are helpful in the calculation of *CoT* for LBE, which also reflects the frame size to be transmitted. Recall also that the transmission of both Wi-Fi and LBE -based schemes depend on their generated random backoff counters. Therefore, under these described conditions, we first generated results in terms of channel access opportunities at q1=4, and with *CoT* for FBE fixed at 1000 μ s. By looking at the Figure 4.6c and Table 4.7, we can conclude that always FBE gets more chances than Wi-Fi and LBE-based schemes, since it does not follow the backoff mechanism like LBE and Wi-Fi. It immediately occupies the channel upon successful CCA of 20 μ s while others are waiting for their random backoff to reach zero during the backoff process. However, if q1 is shorter LBE and Wi-Fi increase their chances especially when TxWiFi gets larger. And this is because, as q1 gets smaller, the *CoT*s of LBE calculated by Equation (4.1) tend to be balanced by that of FBE (1000 μ s) and Wi-Fi, since the minimum *CoT* for LBE is 1625 μ s. Hence, under these conditions, LBE and Wi-Fi based schemes increase their opportunities by taking advantages of idle periods of FBE although FBE is generally the winner as shown in Figure 4.6c.

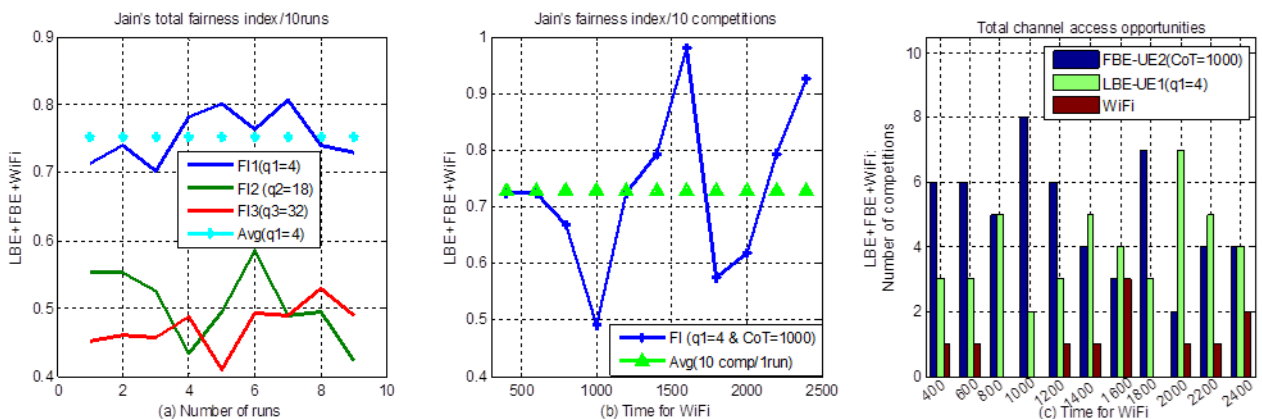

Figure 4.6 Access opportunities & FI in hybrid scenario with variable Wi-Fi transmission time.

The assessment done for this combination also considers the variation of FI for all three users. We evaluate the *FI* of 10 competitions done by both schemes for one run at $q_1=4$ and CoT of FBE equivalent to $1000 \mu s$. These results are shown in Figure 4.6b where the individual FI for every TxWiFi is shown to vary between 49% to 79%. However, the average FI of all three schemes for that single run, is evaluated at 72.88%. We also extend this evaluation by considering 10 runs of both mechanisms, but in this case, we fix different q_1 values at $q_1=4, 18$ and 32 . Under these considerations, the general observation for the results shown in Figure 4.6a, indicates that as q_1 is degraded, the *FI* increases. To be more specific, we calculated the average *FIs* at the respective q_1 values as 75.34%, 50.55% and 47.41% computed at $q_1=4, 18$ and 32 respectively. And these reflect the same conclusion as above; i.e, as q_1 decreases the overall *FIs* increases. During simulation, we also observed that, whatever CoT values of FBE in the considered range ($1ms$ to $10ms$), the same conclusion remains valid.

Table 4.7 Numerical results of the hybrid scenario with variable Wi-Fi transmission time.

TxWiFi	400	600	800	1000	1200	1400	1600	1800	2000	2200	2400
LBE	3	3	5	2	3	5	4	3	7	5	4
FBE	6	6	5	8	6	4	3	7	2	4	4
Wi-Fi	1	1	0	0	1	1	3	0	1	1	2
FI index	0.725	0.725	0.667	0.49	0.725	0.794	0.98	0.575	0.617	0.794	0.926
Average /10 Competitions									0.7288		
Average /10 runs									0.7534		

Case two: to further generalize the conclusion under the same considerations, we also considered another case where channel opportunities are calculated at $q_1=32$ and CoT of FBE fixed $1000 \mu s$. Results demonstrate that FBE scheme maximizes opportunities by almost 93% while others are kept at a lower levels with least chances, but they also have a very high probability of being starved. This high q_1 value causes the CW for LBE to increase. And it is likely possible for LBE to choose a large N, which opens a large space for FBE to always transmit. These results are extended by evaluating *FI* for one run with average degraded to 43.83% at $q_1=32$ and CoT of FBE fixed $1000 \mu s$, while for 10 runs, the average *FIs* are calculated at 50.37%, 53.90% and 77.51% computed at $q_1=32, 18$ and 4 respectively. Hence the same conclusion remains valid for this case also. All results related to these considerations are shown in Appendix A.6.

4.4.3 Hybrid scenario with variable channel occupancy time

Another hybrid scenario considered during our simulation consists of the combination of both Wi-Fi and LAA-based equipments. Here, we vary the *CoTs* for FBE-based schemes from $1000 \mu s$ to $10000 \mu s$, and choose some other values of $q_1=4, 18$ and 32 for LBE and fix $TxWiFi = 400 \mu s$ for Wi-Fi. Similar to the above discussion, we evaluate the results related to the channel access opportunities and further compute the overall Jain's FI for the whole system. Under the same conditions, we perform the overall results assessment for $q_1=4$ as one case and at $q_1=32$ as the second case of this scenario.

Case one: regarding the channel opportunities of the first case, as shown in Figure 4.7c, where FBE-based schemes is again found to be the leader of competition since it has more opportunities than others. This also can be explained in a couple of reasons. At $q_1=4$ (case one); the minimum transmission time is $1625 \mu s$ and it closer to lower CoT values of FBE ($1000 \mu s$). And because of the backoff time adopted by Wi-Fi and LBE-based equipments, FBE can transmit more times while others are waiting for their backoff counters to reach zero as described above. However, since FBE's CoT is variable, the silent periods are widened as CoT increases, since they are decided based on the elapsed CoT. At the same time, TxWiFi is fixed at $400 \mu s$ while q_1 value is fixed and correspondingly CoT is also fixed for LBE. Therefore, if FBE's CoT is getting larger, Wi-Fi and LBE only

take advantages in the wide idle periods for FBE and transmit. This is the case for FBE's $CoT = 6000 \mu s$ and $CoT = 7000 \mu s$ depicted in Figure 4.7c. Other opportunities are computed in the same way depending on the random counters selected.

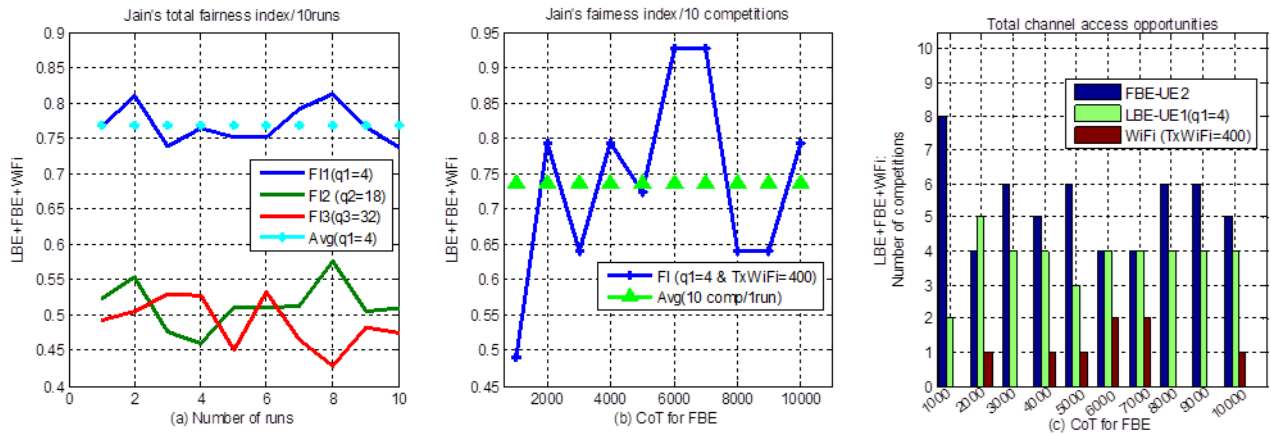

Figure 4.7 Channel opportunities & FI in hybrid scenario with variable channel occupancy time.

The above results are also evaluated in terms of FI at $q1=4$ and $TxWi=400 \mu s$ for one run. And as previously mentioned, the fairness increases as the CoT also is getting larger. However, using the same parameters, the average FI for one run is evaluated as 73.71% as illustrated in Figure 4.7b. We continue this results assessment of this case by extending the calculation of FI for 10 runs. But, in this case, we consider the overall FIs at $q1=4, 18$ and 32 . By observing the Figure 4.7a, we come up with the general conclusion that the lower is the $q1$ values the higher is the FI . This observation is also supported by the average FIs such as 76.89%, 51.39% and 48.92% calculated at $q1=4, 18$ and 32 respectively. It has been shown that for different values of $TxWiFi$, the conclusion remains the same. The following Table 4.8 shows numerical results for the above detailed combination.

Table 4.8 Numerical results of the hybrid scenario with variable channel occupancy time.

CoT2	1000	2000	3000	4000	5000	6000	7000	8000	9000	10000
LBE	2	5	4	4	3	4	4	4	4	4
FBE	8	4	6	5	6	4	4	6	6	5
Wi-Fi	0	1	0	1	1	2	2	0	0	1
FI index	0.49	0.794	0.641	0.794	0.725	0.926	0.926	0.641	0.641	0.794
Average /10 Competitions										0.7371
Average /10 runs										0.7689

Case two: another case, considered for simulation in this combination is the evaluation of results under same conditions, but in this case, we keep the value of $q1$ at the maximum value ($q1=32$). According to the results, FBE grabs most of the channel access opportunities than others. In some cases, Wi-Fi and LBE-based are completely starved. The corresponding FI is also found oscillating up and down around the average FI of 47.55% for a single run. The overall FIs for 10 runs give clear picture than one run and reflect the same conclusion as above, as it also indicated by the computed average FIs , such as 50.21%, 54.15% and 75.45% evaluated at $q1=32, 18$ and 4 respectively. Hence, the same conclusion is again confirmed. That is, as $q1$ increases, the FI degrades. These results are shown in Appendix A.7.

4.5 Chapter Summary

In this chapter, we have described the performance of LAA-based MAC mechanism proposed by 3GPP in order to make them coexisting with each other or with Wi-Fi-based access mechanism in the shared 5 GHz band. We have also presented the results generated by Matlab simulation for every scheme through their combinations, in pairs; when two-by-two equipments compete for the channel access. We also evaluated the performance of different combinations of hybrid scenarios constituted by three equipments competing for channel access simultaneously.

The evaluation was performed by varying the different considered parameters such as q_1 , TxWiFi and CoT of LBE, Wi-Fi and FBE-based mechanisms respectively. The variation of these parameters reflects the variation of their transmission time as well as their corresponding frame sizes. Through simulations, we presented their performance in terms of channel access opportunities and generalized it in terms of Jain's FI which gives the general and a clear picture of the considered combinations.

Regarding results, we demonstrated that always FBE schemes get more opportunities on the shared channel in all combinations where it is involved. This is because of its initial CCA of at least 20 μ s, which is applied once during competitions and decides the transmission accordingly; while other schemes such LBE and Wi-Fi wait for their backoff numbers to reach zero for any transmission decision. This waiting time opens room for FBE-based schemes and allows them to transmit in most of the time. On the other hand, Wi-Fi and LBE-based mechanisms have chance to transmit if they take advantage in the idle periods of FBE during competition.

However, although FBE schemes get more opportunities than others, it has been shown that its performance with others FBEs is very poor, as they prone to serious collisions in the case of synchronous scenarios. On the other hand, only one equipment (FBE1) maximizes the channel opportunities in case of asynchronous schemes which yield the lowest average FI of 50%. These two points were noted and further improved in the next chapter.

5 Performance Evaluation of the Proposed Backoff Algorithms

As discussed earlier, FBE-based schemes have been shown with better performance than others. And this performance can impact other access mechanisms during channel access competitions. In addition to this, in some cases the performance of LBE-based mechanisms is also critical, especially when they compete with other non LBE-based schemes. Since our main target is to allocate equal shares of channel opportunities to all access mechanisms, we propose here in this chapter, the improved FBE and LBE-based mechanisms; referred to as E-FBEs and E-LBEs respectively. These proposed schemes perform better than the original mechanisms, even in the cases of multi-user scenarios. Parameters in Table 4.1 are also used in this chapter, in order to generate improved performance for each corresponding combination. Similar to the above discussion, the performance is also shown in terms of channel access opportunities and Jain's FI. Note here that the higher level of FI indicates the best performance. Also, some of the results are postponed to appendices due to the presentation priority.

5.1 Numerical Results of the E-FBE-based Mechanisms

The proposed E-FBE access mechanisms consist of the introduction of backoff mechanism to the original FBE schemes. In order to be consistent with other LAA-based mechanisms, we kept the same range of backoff scaler q from 4 to 32. The E-FBE random counter N is therefore selected from 1 to $q = 32$, i.e. ($N \in [1, q]$) as it is the case for LBE schemes. The proposed backoff mechanism for E-FBE eliminated the long idle period appeared for a failed transmission of original FBE as well as the selfishness of getting more channel opportunities than others. The transmission of the new proposed E-FBE is for now decided by the random counter N depending on its CW length. However, the silent period of 5% evaluated after transmission of original FBE was kept intact for the new E-FBEs.

Generally, the performance of E-FBE increased considerably compared to that of the original FBE schemes. In the following, we present results of E-FBE-based equipment, when it competes with other E-FBE, original LBE or Wi-Fi-based mechanisms. Similar to the above discussion, we also consider different E-FBE combinations of equipments assumed to compete for the channel access. Also, we assume that all mechanisms engaged in competitions have originally packets to send.

5.1.1 E-FBE and other E-FBEs with variable channel occupancy time

For this pair of equipments, we consider two E-FBE-based equipments competing for accessing the channel. We mentioned earlier that we didn't show results of a collision case for two original FBEs, in synchronous mode. We also mentioned that one of them (say FBE1) can keep on maximizing all opportunities in asynchronous cases. These two weaknesses are eliminated by the combination of two E-FBEs which adopt backoff mechanism during competition. We denote E-FBE1 and E-FBE1 to indicate those two E-FBE-based equipments. Recall also that both schemes follow the backoff mechanism as mentioned above. Regarding parameters used during the simulation, we considered both q_1 values of E-FBE1 and q_2 values of E-FBE2 to be select from the interval $I_0 \in [4, 32]$. And their respective backoff random counters N_1 and N_2 are selected from interval $I_1 \in [1, q_1]$ for E-FBE1 and $I_2 \in [1, q_2]$ for E-FBE2. The scheme whose backoff counter reaches zero first during competition, initiates its transmission immediately as illustrated in Figure 3.10. The performance related to this scenario is depicted in Figure 5.1 with numerical results shown in Table 5.1.

To evaluate the performance of results related to this combination, we fix some q_1 values to $q_1 = 32, 18$ and 4 for E-FBE1 while keep q_2 fixed to $q_2 = 32$ and the $CoT = 1000 \mu s$ for E-FBE2. The variation parameter is CoT of E-FBE1 which varies from $1000 \mu s$ to $10000 \mu s$. The results generated for this scenario under these conditions are shown in Figure 5.1c which shows the channel opportunities gained by any of the E-FBEs using this access system. According to this figure, although some disparities are observed, it is shown that both schemes got almost equal chances on channel access for 10 competitions set during our simulation. Note here that our target is to allocate equal opportunities of channel access by 5 times for each scheme.

Table 5.1 Access opportunities and FI of E-FBE1+E-FBE2 with variable channel occupancy time.

CoT1	1000	2000	3000	4000	5000	6000	7000	8000	9000	10000
E-FBE1	5	5	6	4	4	6	4	3	5	5
E-FBE2	5	5	4	6	6	4	6	7	5	5
FI index	1	1	0.962	0.962	0.962	0.962	0.962	0.862	1	1
Average /10 Competitions									0.967	
Average /10 runs									0.9727	

The experienced inequality of access opportunities can be explained by the random counters $N1$ and $N2$ selected by both schemes. That is, although $N1$ and $N2$ are selected from the same range of q values, it is likely impossible for both schemes to select the same counters. If $N1$ is shorter, E-FBE1 can have higher probability of having more opportunities than E-FBE2 as it is the case for $CoT1 = 4000 \mu s$ and $CoT1 = 7000 \mu s$. On the other hand, for a larger $N1$, E-FBE2 gets more chances to the channel since it may have selected a random number ($N2$) shorter than $N1$. The latter case is shown for $CoT1 = 5000 \mu s$, $CoT1 = 6000 \mu s$ and $CoT1 = 9000 \mu s$ of Figure 5.1c. In addition to this, $CoT2$ is fixed to $1000 \mu s$; meaning that the 5% idle period is also fixed for E-FBE2 while that of E-FBE1 is variable since it depends on the variable $CoT1$. Therefore, E-FBE2 can take advantage of that long waiting time for decrementing its counter $N2$, which may reach zero first and confirms its transmission.

The performance of this combination is also shown in terms of FI evaluated by utilizing Equation (4.1) in order to generalize the performance of the whole system for one run. Figure 5.1b illustrates the behaviour of FI calculated at fixed $q1 = 32$, $q2 = 32$ and $CoT2 = 1000 \mu s$ with variable $CoT1$. As shown by the same figure, the FI increases depending upon the channel opportunities got by both E-FBE1 and E-FBE2. The average FI is raised to 96.70% for only one run. The simulation is further extended to 10 runs in order to assess the overall FI behaviours for different q values as shown in Figure 5.1a. In this case, we fixed $q1=4, 18$ and 32 and vary $CoT1$ for E-FBE1 while $q2$ and $CoT2$ of E-FBE2 are also fixed to $q2 = 32$ and $CoT2 = 1000 \mu s$ respectively. Also, by considering same parameters and fix q values at $q1=4, q2=4$ and $CoT2 = 1000 \mu s$ similar results are generated. Under these considerations, we realized that the FI increases as $q1$ and $q2$ tend to have equal values. This is proved by average FI s evaluated for this combination which are 59.79%, 90.10% and 97.27% computed at $q1 = 4, q1 = 18$ and $q1 = 32$ respectively. And these average FI s reflect the same observation that the more $q1$ value gets closer to $q2$, the higher the average FI . For the application purposes, this indicates the fairness between equipments operating on the shared channel under these considerations. We also verified that any change of $CoT2$ of E-FBE2 does not affect the general observations.

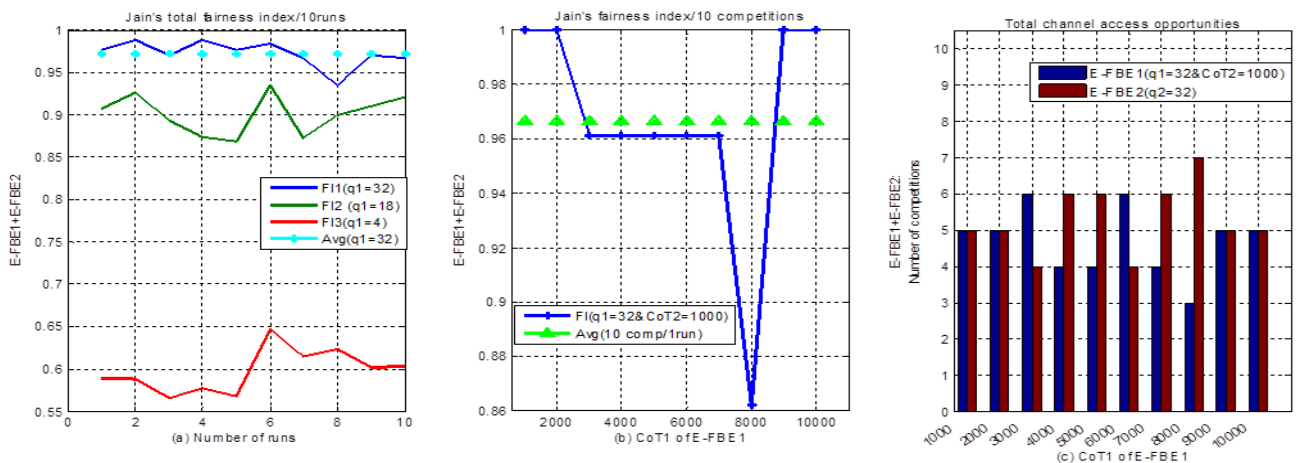

Figure 5.1 Channel opportunities and FI of two E-FBEs with variable channel occupancy time.

Moreover, if there is a large difference between q_1 and q_2 , the E-FBE equipment with shorter backoff scaler will be always the winner and occupies the channel with large number of chances. We evaluate access opportunities of this case at $q_1=4$ and $q_2=32$ with the same parameters as above. Since there is an imbalance between q_1 and q_2 , results also present large disparities between channel access opportunities and the corresponding average FI degrades to 65.07% for only a single run while it becomes 58.75% for 10 runs. Again, at $q_1=18$ and $q_1=32$, the average *FIs* are evaluated as 89.43% and 96.57% respectively which also reflect the same observation. Results illustrating the disparate access opportunities between E-FBE1 and E-FBE2 are shown in Appendix B.1.

5.1.2 E-FBE and original LBE with variable backoff scaler

During the simulation, we also assessed the performance of the E-FBE and original LBE access mechanisms. For this evaluation, we assume E-FBE and LBE equipments compete for the channel access by following their respective backoff mechanism described above. Similar to the previous combination, we also assume that the random numbers of both schemes are selected from the same range Io of q_1 and q_2 for E-FBE and LBE-based equipments respectively, i.e, $Io \in [4, 32]$. Therefore, depending on the random counter selected, the transmission is initiated if it is decremented and reaches zero first for one of these mechanisms. Results of this combination are shown in Figure 5.2 and Table 5.2

For this evaluation of channel access opportunities, we consider q_2 and CoT_2 for E-FBE to be fixed at 32 and 1000 μs respectively and then vary q_1 for the original LBE scheme. As shown in Figure 5.2c, these schemes have the tendency of getting almost equal chances as q_1 increases from $q_1=4$ to $q_1=32$. LBE-based scheme maximizes all opportunities for q_1 values close to $q_1=4$ while E-FBE is shown starved. This is because the range from which, LBE random counter is selected is minimum compared to that of E-FBE scheme. At this value ($q_1=4$), LBE always selects shorter counter N from 1 to $q_1=4$ while E-FBE has high probability of selecting a large random counter since its q_2 value is fixed to 32, i.e, the counter for E-FBE is chosen from 1 to $q_2=32$; and this always favors LBE scheme. On the other hand, as q_1 gets closer to $q_2=32$, these schemes tend to have approximately equal CW length, which may allow both schemes to also get approximately equal chances as shown Figure 5.2c and Table 5.2 for $q_1 = 27$ to $q_1 = 31$. In addition to this, E-FBE schemes stay silent for 5% of its CoT_2 after a successful transmission, while LBE schemes do not have this idle period. Therefore, LBEs can also benefit from this gap and occupy the channel which can also increase their number of access opportunities.

Table 5.2 Numerical results of the E-FBE and original LBE with variable backoff scaler.

q1 of LBE	4	5	6	7	8	9	10	11	12	13	14	15	16	17	18
LBE	10	9	9	9	9	9	9	7	7	7	7	7	7	7	7
E-FBE	0	1	1	1	1	1	1	3	3	3	3	3	3	3	3
FI_index	0.500	0.610	0.610	0.610	0.610	0.610	0.610	0.862	0.862	0.862	0.862	0.862	0.862	0.862	0.862
q1 of LBE	19	20	21	22	23	24	25	26	27	28	29	30	31	32	
LBE	5	7	5	6	6	5	5	6	5	5	5	5	5	4	
E-FBE	5	3	5	4	4	5	5	4	5	5	5	5	5	6	
FI index	1	0.862	1	0.962	0.962	1	1	0.962	1	1	1	1	1	0.962	
Average /10 Competitions														0.8539	
Average /10 runs														0.8569	

By considering the same parameters, we also evaluated the performance of this combination in terms of *FI*, i.e, for $q_2 = 32$ and $CoT_2 = 1000 \mu s$ with variable q_1 for a single run. As shown in Figure 5.2b, the results reflect similar observations that *FI* increases as the q_1 values increases with average *FI* boosted to 85.39%. By repeating the same simulation experiment, we extended the competition to 10 runs in order to globalize this observation for this combination. Similar to the previous case, we consider $q_2=32$ and variable q_1 , by also fixing other two extra q_2 values to 4 and 18 for more

clarifications. Results illustrating this consideration are shown in Figure 5.2a. The average *FIs* evaluated by considering those parameters are computed to be 85.69%, 91.01% and 72.55% calculated at $q_2 = 32, 18$ and 4 respectively. However, the average *FI* at $q_2 = 18$ is showed to be the highest of this scenario because it is located at the middle of q_1 range. Hence, as the variable q_1 gets closer to the fixed $q_2 = 18$ (middle value), *FI* increases on both sides towards the fixed $q_2=18$, while at both ends of q_1 range, the *FI* degrades. But in general, by looking at Figure 5.2 and Table 5.2, we observe that the *FI* increases as the variable q_1 increase to the maximum value of the range. Throughout this simulation, we also verified that any change of CoT_2 for E-FBE, has no impact on the general observations.

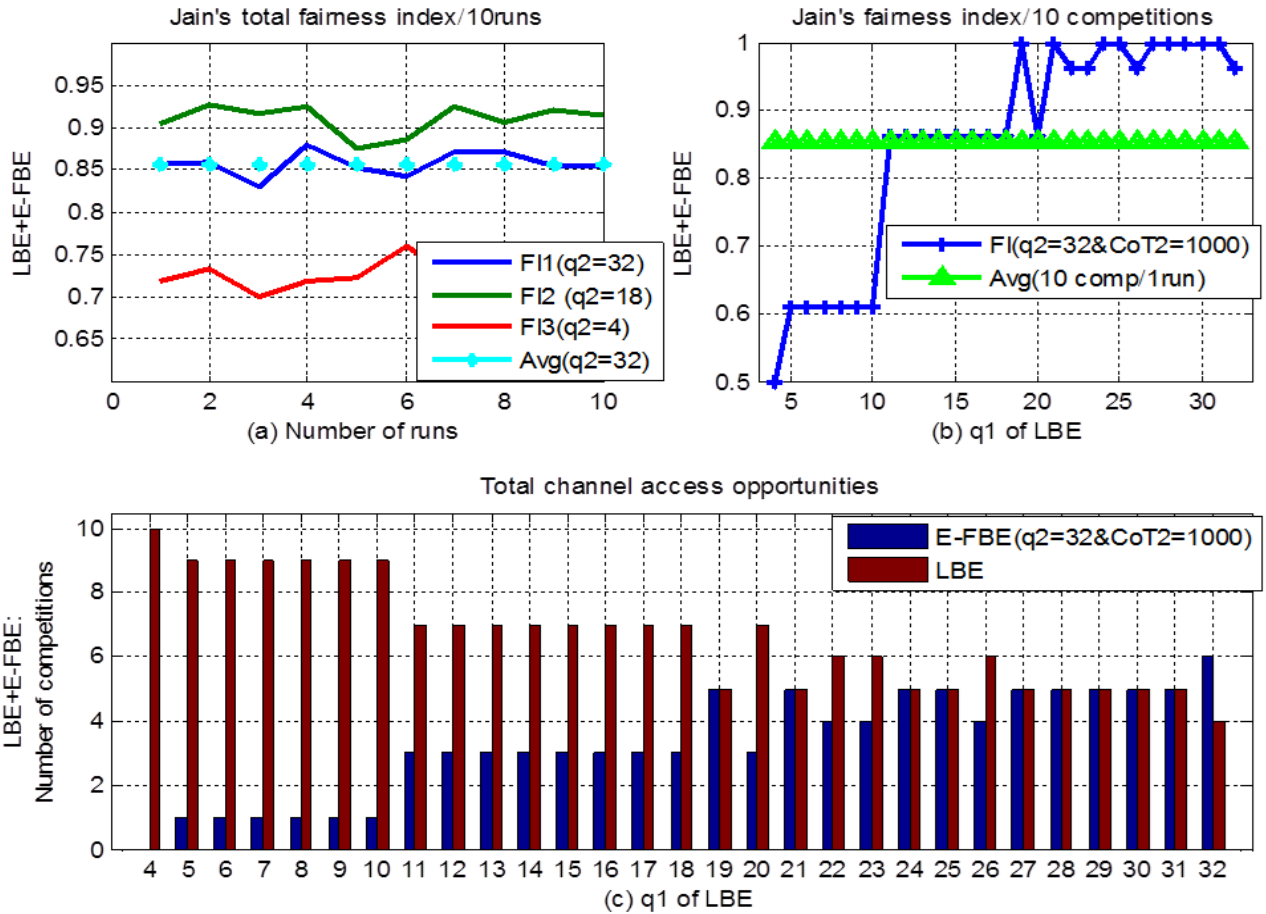

Figure 5.2 Access opportunities and FI of the E-FBE and original LBE with variable backoff scaler.

To be more specific for this consideration, we also show extra results in Appendix B.2 by considering similar parameters but in this case with q_2 value fixed at 4 and variable q_1 . The evaluation of this case shows that E-FBE is always the winner since it has shorter range of random counter N (1 to 4), and LBE scheme is shown starved at the end of q_1 range. The average *FI* is evaluated as 69.88% for one run, while it increases to 72.52% , 89.95% and 85.77% for 10 runs when *FI* is computed at $q_2=4, 18$ and 32 respectively. Again, the same observation is reflected for this scenario and the *FI* at $q_2=18$ is shown to be the largest because of the same reason explained above.

5.1.3 E-FBE and LBE with variable channel occupancy time

From the previous combination, we now present results of improved FBE and the original LBE when the CoT_1 of the E-FBE is changing from $1000 \mu s$ to $10000 \mu s$. For this simulation, we fixe both q_1 and q_2 to 32 ; meaning that both schemes are assigned the same range where their respective random numbers are selected from. Regarding channel opportunities generated under these considerations as shown in Figure 5.3c and in Table 5.3, we observe that both schemes get almost equal chances to access the channel. Disparities experienced are caused by the random counters which may be

different for both schemes. However, they may also be caused by the silent period of 5% for E-FBE which opens free space for original LBEs and favors them during competitions.

To assess the performance of the whole system, we performed the Matlab simulation for a single run, to check for which extent the system is fair. We therefore computed the FI depicted in Figure 5.3b where the average FI is 95.32%. This FI is higher since both q_1 and q_2 are set to the same value. After that, we performed several single simulations by choosing different values of q_1 and q_2 . At the end, we observe that similar average FI is achieved if q_1 is equivalent to q_2 for whatever value of q_1 or q_2 ($q_1 = q_2 = q$, either short or large value) chosen from the given range. That is, if E-FBE and LBE based equipments are assigned the same q value, their random counters are therefore selected from the same range (1 to q). And this can increase the FI between them and allow them to likely get equal opportunities to the channel access. However, the general observation indicated that as q_1 increases, FI also increases as explained hereinbelow.

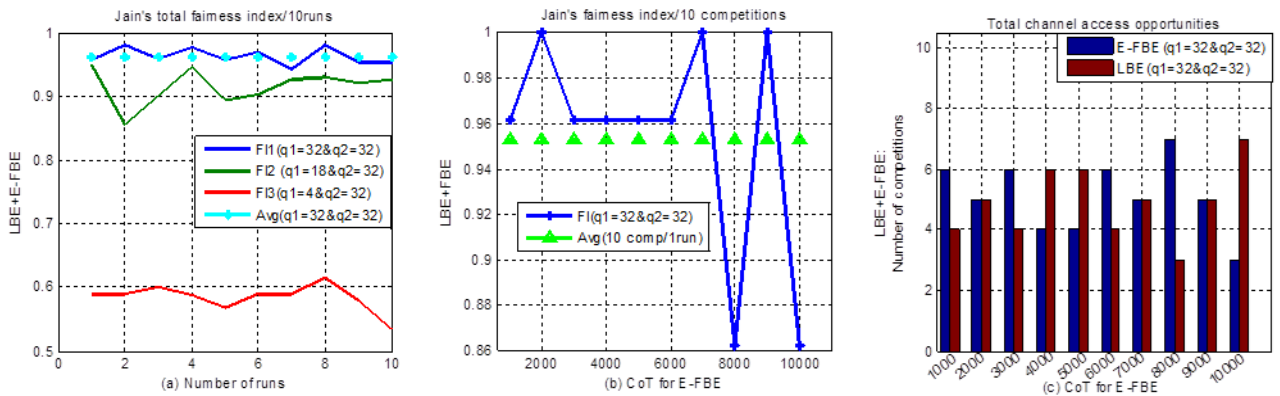

Figure 5.3 Performance of the E-FBE+LBE with variable channel occupancy time ($q_2=32$).

For the simulation extended to 10 runs, we kept q_2 fixed at 32 and choose some q_1 values as $q_1=32$, 18 and 4 in order to demonstrate the aforementioned observations. As shown in Figure 5.3a, as long as q_1 increases towards the fixed q_2 value ($q_2 = 32$), FI also increases. This is also proved the average FIs calculated as 96.32%, 91.57% and 58.37% calculated at $q_1=32$, 18 and 4 respectively. Hence, the larger the q_1 values, the higher the FI and vice versa. Similar observation was experienced by keeping q_1 fixed to $q_1 = 32$, and fix some of q_2 values to $q_2=4$, 18 and 32 respectively.

Table 5.3 Numerical results of the E-FBE+ LBE with variable channel occupancy time ($q_2=32$).

CoT	1000	2000	3000	4000	5000	6000	7000	8000	9000	10000
LBE	4	5	4	6	6	4	5	3	5	7
E-FBE	6	5	6	4	4	6	5	7	5	3
FI index	0.962	1	0.962	0.962	0.962	0.962	1	0.862	1	0.862
Average /10 Competitions									0.9532	
Average /10 runs									0.9632	

When q_1 of LBE is fixed to the minimum value ($q_1 = 4$) and q_2 values is set to the maximum value ($q_2 = 32$) severe imbalances between channel access opportunities are experienced because the CW lengths will completely be different. Under these conditions, LBE always gets higher number of chances and results yield a poor average FI of 57.84% for a single run, while for 10 runs, the average FIs are calculated as 58.78%, 90.51% and 97.05% computed at $q_1=4$, 18 and 32 respectively, hence the same observation mentioned above is also maintained for this combination as shown in Appendix B.3. In a similar way, by exchanging these parameters and set q_2 to 4 while keeping q_1 fixed to 32, the same results are generated. But in this case, E-FBE gets more opportunities than original LBE scheme.

5.1.4 E-FBE and Wi-Fi with variable channel occupancy time

The assessment of results related to the channel access competitions between E-FBE and Wi-Fi is performed by setting the involved parameters and by also recalling that both schemes adopt backoff mechanism to select random counters; where Wi-Fi follows exponential backoff mechanism. Here, we present results of two cases. One case consists of E-FBE and Wi-Fi-based equipments competing for the channel access with E-FBE's CoT variable. Another case is evaluated when both schemes compete, but in this case, we vary the transmission time for Wi-Fi-based schemes.

Case one: for the first combination, we initially set $q2$ value of E-FBE to $q2 = 32$ and the transmission time for Wi-Fi to $TxWiFi = 400 \mu s$, and then let E-FBE's CoT vary from $1000 \mu s$ to $10000 \mu s$. For the simulation results shown in Figure 5.4c and Table 5.4, both schemes are generally found with some gap between them given 10 competitions under consideration. As mentioned above, this is because both schemes follow the random backoff mechanism. However, for CoT values close to $1000 \mu s$, Wi-Fi gets poor performance (for example at $CoT=4000 \mu s$) while it increases its chances as CoT increments to the values closer to $10000 \mu s$. This is explained not only by the mentioned backoff number, but also by the 5% idle period calculated by E-FBE after every successful transmission. That is, if CoT is larger, the silent period also increases. And this may increase the benefit to Wi-Fi since it will find the room for decrementing its counter, in addition to the E-FBE length. This is the case for $CoT=8000 \mu s$ and $CoT=9000 \mu s$.

Table 5.4 Fairness indices for E-FBE+ Wi-Fi pair with variable channel occupancy time.

CoT	1000	2000	3000	4000	5000	6000	7000	8000	9000	10000
E-FBE	5	8	7	9	7	6	7	4	3	6
Wi-Fi	5	2	3	1	3	4	3	6	7	4
FI index	1	0.735	0.862	0.61	0.862	0.962	0.862	0.962	0.862	0.962
Average /10 Competitions									0.8678	
Average /10 runs									0.8763	

For evaluating the performance for the whole system, we keep the same parameter and calculate the FI for a single simulation run. In that case, the results illustrated in Figure 5.4b indicate that the FI increases as the variable CoT increases. The total average FI evaluated for this single run is 86.78%. However, this parameter has little effect than that of $q2$, which decides the transmission after backoff mechanism as shown in Figure 5.4a when the simulation is run for 10 rounds. Here, we consider $q2$ values of E-FBE to be fixed at $q2 = 4, 18$ and 32 . Similar to the above consideration, we also let CoT vary from $1000 \mu s$ to $10000 \mu s$. By assessing the results of the same figure, we observe that the overall FI increases as $q2$ values increases. And this is because the random number range is widened for E-FBE as $q2$ increases, which opens a vacant space for Wi-Fi to take advantages. This is demonstrated also by the averaged FIs evaluated as 87.63%, 81.78% and 64.95% computed when $q2$ is fixed to 32, 18 and 4 respectively.

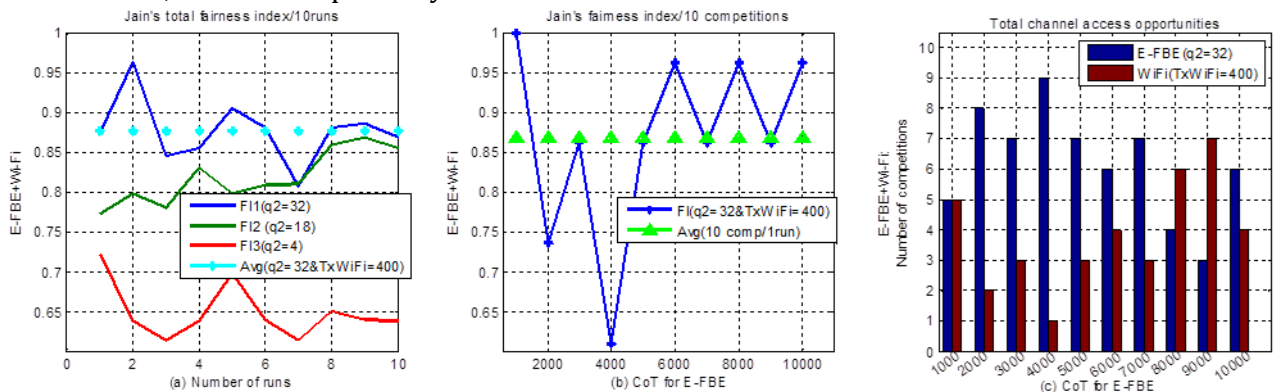

Figure 5.4 Access opportunities and FI of the E-FBE+ Wi-Fi with variable channel occupancy time.

Note also here that, CCA sensing time for E-FBE is $20 \mu\text{s}$ while $DIFS = 34 \mu\text{s}$ for Wi-Fi scheme. Meaning that, E-FBE can start decrementing its counter while Wi-Fi is still sensing the channel. Therefore, if q_2 is shorter, Wi-Fi scheme is starved and correspondingly, the overall FI also decreases. Results of this case are shown in Appendix B.4, where q_2 is fixed to 4. At this value ($q_2=4$), Wi-Fi gets no chances for shorter CoT values, while it gets little chance as CoT increments since it benefits from the E-FBE's 5% idle period. For a single run, the average is calculated as 60.36% while for 10 rounds is 63.95%, 78.86% and 86.80% evaluated at $q_2=4, 18$ and 32 respectively. For all these cases, we have also verified that any change of TxWiFi doesn't affect the general observation.

Case two: another case consists of the improved FBE and Wi-Fi with variable TxWiFi. In this combination, we fix q_2 of E-FBE to 32 and allow TxWiFi vary from $400 \mu\text{s}$ to $2400 \mu\text{s}$. Similar to the above scenario, the channel opportunities allocated increases if the q_2 value of E-FBE is large. For the results illustrating this scenario as shown in Appendix B.5, some disparities are observed. However, when evaluate the FI for both scheme, we observe that the average FI boosts to 88.19% for one run while it degrades to 88.49%, 80.42% and 68.80% for the 10 rounds simulated at $q_2=32, 18$ and 4 respectively. Hence, for this scenario, we also observe that the FI increases as q_2 increases and vice versa. For this scenario, we also checked and realized that the performance remain intact for any change of E-FBE's CoT.

5.1.5 E-FBE in hybrid scenario with variable backoff scaler

We now consider the hybrid scenario, where both three access mechanisms such as E-FBE, original LBE and Wi-Fi are assumed to compete for the channel access simultaneously. Here, it is of paramount important to remind that both schemes follow the backoff mechanism to choose their respective backoff counters according to the principles explained in Chapter 3. The random counters are selected from 1 to q_1 and from 1 to q_2 for LBE and E-FBE schemes respectively with both q_1 and q_2 laid in the same range from 4 to 32, while Wi-Fi follows exponential backoff for choosing its random number.

The results for this combination are shown in Figure 5.5 with numerical results shown in Table 5.5. To assess them, we fix some values of q_2 to 4, 18 and 32, and vary q_1 parameter of original LBE. The CoT and TxWiFi are also fixed to $1000 \mu\text{s}$ and $400 \mu\text{s}$ for E-FBE and Wi-Fi respectively. Regarding the channel access opportunities, their results evaluation is performed by considering the above parameters and $q_2 = 32$. The simulation shows that channel resource allocation increases as q_1 value tends to be equal to q_2 value; indicating that E-FBE and LBE can select their backoff numbers from approximately equal range. Similarly, Wi-Fi can take advantage of that long CW for E-FBE and LBE and transmit. Under these conditions, we can observe that in Figure 5.5c, LBE gets more chance for shorter q_1 values while at the end of the range ($q_1=32$), the opportunity allocation is almost balanced for both schemes.

Table 5.5 Numerical results of the E-FBE in hybrid scenario with variable backoff scaler.

q1 of LBE	4	5	6	7	8	9	10	11	12	13	14	15	16	17	18
LBE	9	8	6	8	7	6	8	8	8	7	5	5	6	4	5
E-FBE	1	1	3	2	2	4	1	2	2	2	2	1	2	5	4
Wi-Fi	0	1	1	0	1	0	1	0	0	1	3	4	2	1	1
FI_index	0.407	0.505	0.725	0.490	0.617	0.641	0.505	0.490	0.490	0.617	0.877	0.794	0.758	0.794	0.794
q1 of LBE	19	20	21	22	23	24	25	26	27	28	29	30	31	32	
LBE	7	3	4	5	5	5	4	4	4	5	4	3	3	4	
E-FBE	3	3	4	3	4	3	6	6	1	3	6	5	3	4	
Wi-Fi	0	4	2	2	1	2	0	0	5	2	0	2	4	2	
FI index	0.575	0.980	0.926	0.877	0.794	0.877	0.641	0.641	0.794	0.877	0.641	0.877	0.980	0.926	
Average /10 Competitions													0.721		
Average /10 runs													0.7323		

Moreover, the evaluation of FI also proves that observation shown in Figure 5.5b. We can also see that as q_1 increments, the FI also increases. The average FI calculated for one run is 72.10%. For 10 rounds, we consider q_2 parameter to be set as $q_2 = 4$, $q_2 = 18$ and $q_2 = 32$. Results of this case are shown in Figure 5.5a, and it can also be seen that FI increases when q_1 also increases towards a fixed q_2 value. This is numerically proved by the average *FIs* evaluated as 61.48%, 75.73% and 73.23% when q_2 is set to $q_2 = 4$, $q_2 = 18$ and $q_2 = 32$ respectively. The average FI is larger for $q_2=18$ because it is a centre value of the range; and FI is higher for both sides of the middle range ($q_2 = 18$). The counterpart case whose results are shown in Appendix B.6 were simulated when $q_2=4$ and the average FI degraded to 57.42% for a single run. In this case, E-FBE is always the winner since it possesses the minimum range from which, the random number is selected. For both cases, we also verified that any increase in TxWiFi, will have not affect the global performance of the system.

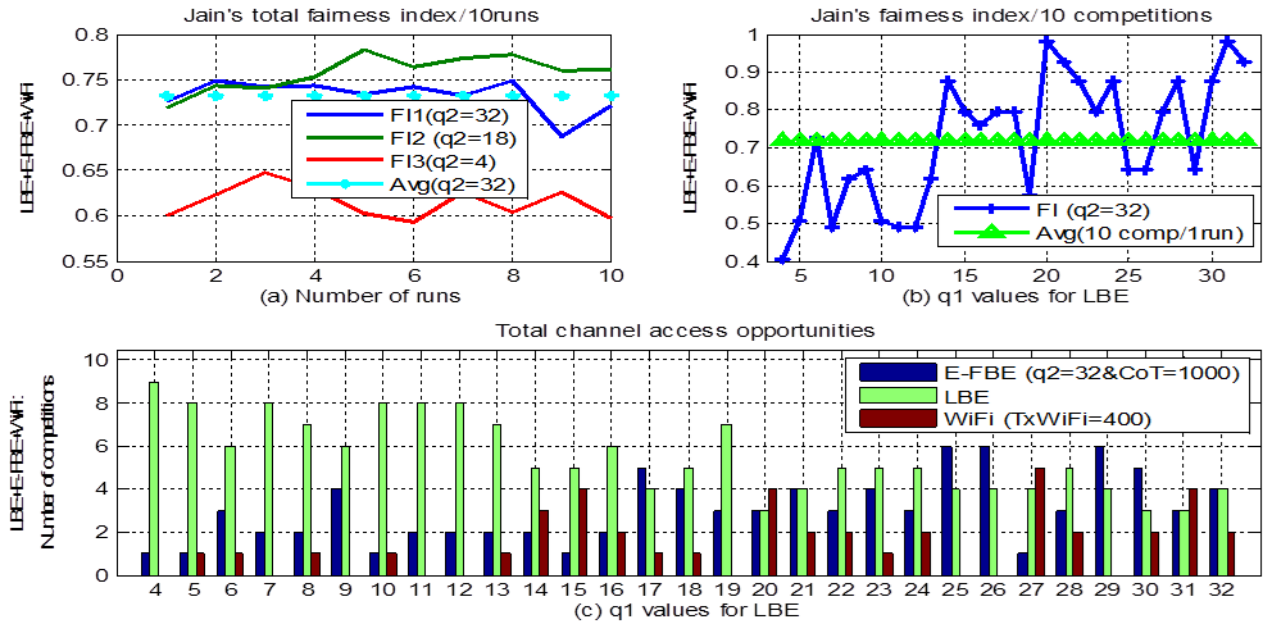

Figure 5.5 Access opportunities & FI of the E-FBE in hybrid scenario with variable backoff scaler.

5.1.6 E-FBE in hybrid scenario with variable CoT and Wi-Fi transmission time

The assessment of the performance of the E-FBE-based equipment competing with Wi-Fi and LBE-based equipments on the shared channel can also be done by considering the variation of E-FBE and TxWiFi. Herein this section, we present results based on two separate scenarios which are based on the aforementioned change of CoT and TxWiFi.

Scenario one: for this scenario, the performance is evaluated by setting useful parameters. Similar to the previous section, here also we consider the respective parameters q_1 and q_2 for E-FBE and LBE to be selected from the same interval ranging from 4 to 32. We also fix the transmission time for Wi-Fi to $TxWiFi = 400 \mu s$, and then vary the E-FBE's CoT from $1000 \mu s$ to $10000 \mu s$. Figure 5.6 and Table 5.6 show the simulated results under these considerations.

Table 5.6 Access opportunities & FI in hybrid scenario with variable channel occupancy time.

CoT	1000	2000	3000	4000	5000	6000	7000	8000	9000	10000
LBE	5	4	3	1	6	3	3	5	4	3
E-FBE	4	5	5	4	4	3	3	4	4	3
Wi-Fi	1	1	2	5	0	4	4	1	2	4
FI index	0.794	0.794	0.877	0.794	0.641	0.98	0.98	0.794	0.926	0.98
Average /10 Competitions									0.856	
Average /10 runs									0.8564	

We first evaluated the channel access opportunities by considering the above parameters. However, q_1 and q_2 are fixed to 32 for both E-FBE and original LBE. As it is shown in Figure 5.6c and Table 5.6, results indicate that both schemes approximately get chances in general, even though some disparities are experienced, especially for Wi-Fi scheme. And this is because of their respective adaptation of backoff mechanisms explained in the previous sections. Hence, depending on the chosen random counter and the backoff principle, any of these schemes can get equal or more chances on the channel. We also verified different parameters, and realized that for whatever value of q_1 or q_2 , if the variable q_1 parameter tends to be equal to the fixed q_2 parameter, i.e., $q_1 = q_2 = q$, E-FBE and LBE perform better, while Wi-Fi gets least chances to the channel access, when q value is shorter. Meaning that, if q is large, both schemes get almost equal chances (as it is the case for $q_1=32$ and $q_2=32$ in Figure 5.6c) while for shorter q , Wi-Fi gets very little chances (for example, $q_1 = 4$ and $q_2 = 4$). The reason for this is that both E-FBE and LBE consist of similar CCA sensing time (CCA=20 μ s) which is less than Wi-Fi DIFS (DIFS=34 μ s). Therefore, depending on the selected random counters, it is likely possible for E-FBE and LBE-based equipments to decide their transmissions first while Wi-Fi based equipment is still scanning the channel.

By evaluating these results in terms of FI for $q_1=32$ and $q_2=32$, we realized that the average FI increased to 85.60% for a single run as shown in Figure 5.6b. We further extended the simulation to 10 simulation rounds. But in this case, we let q_2 parameter fixed to 32 for E-FBE, and choose some q_1 values as $q_1=4$, 18 and 32 selected from the given range for LBE and then initiate the simulation. As shown in Figure 5.6a, results indicate that as q_1 increases towards the fixed q_2 value ($q_2=32$ in this case), the FI also increases. This is also proved numerically by the average FIs of 47.43%, 77.28% and 85.64% evaluated at $q_1=4$, 18 and 32 respectively. For this simulation, we also verified and observed that any change of TxWiFi has no effect on the general conclusion for this case.

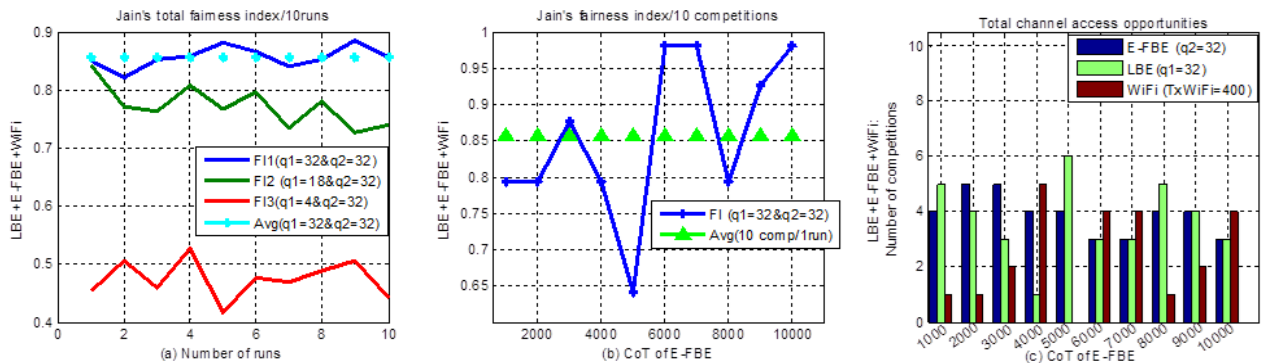

Figure 5.6 Fairness of the E-FBE in hybrid scenario with variable channel occupancy time.

In Appendix B.7, we also show results of another case simulated when q_1 of LBE is set to 4, q_2 and TxWiFi remain fixed to $q_2 = 32$ and $TxWiFi = 400 \mu$ s respectively. In this case, it is shown that both Wi-Fi and E-FBE get least number of opportunities to the channel. The average FI is lowered to 45.96% for one run. However, if we consider different q_1 values for 10 runs again, we realize that the average FIs become 46.49%, 77.41% and 84.70% computed at $q_1=4, 18$ and 32 respectively. Hence, similar observation is maintained.

Scenario two: another scenario considered in this section consists of varying TxWiFi from $TxWiFi = 400 \mu$ s to $TxWiFi = 2400 \mu$ s. Other parameters are the same as that used in the first scenario. With these considerations, we realized that the channel access opportunities are almost the same for all three schemes. But this is happen when parameters q_1 and q_2 have comparatively equal and larger values. For the case whose results are shown in Appendix B.8, we consider $q_1=32$ for LBE and $q_2=32$ and CoT=1000 μ s for E-FBE. Similar to the first scenario, the average FI was evaluated as 83.01% for only a single run. However, by taking different q_1 values as $q_1=4$, 18 and 32 and simulate for 10 rounds, we realized that the average FIs become 46.35%, 77.87% and 84.60% evaluated at both $q_1=4$, 18 and 32 respectively. Therefore, for this scenario, the general observations show that the FI increases as q_1 values increases to the fixed q_2 values. However if q_1 and q_2 take

short values ($q_1=q_2=q$), Wi-Fi gets very little chance to the shared channel. Hence, it is required that q_1 and q_2 be comparatively large in order to get higher FI, which also reflects the same conclusion as in the scenario one. For this scenario, we also observed that any change of CoT has no impact on the general observation.

5.2 Numerical Results of E-LBE-based Access Mechanisms

Having examined all access schemes and having realized that FI is still below 100%, we proposed another insight of improving the original LBE based access mechanisms. As briefly mentioned above, we have proposed the extension of the range from which q values are selected. After examining different ranges, we proposed the new interval ranging from $q=64$ to $q=100$. Since the random backoff counter is selected from 1 to q , the proposed interval reflects the extension of CW for LBE schemes. Therefore, by using the random counter selected from the new interval, LBE-based access mechanisms have been shown with the best performance, depending on other equipments they are competing with. However, in some combinations, poor performance was also experienced as explained below.

5.2.1 E-LBE and other E-LBEs with variable backoff scaler

In this combination, we evaluate the performance of E-LBE and other E-LBE-based equipments assumed to compete for the channel access. We consider a pair of two E-LBEs referred to E-LBE1 and E-LBE2. And as mentioned above, we allow these two equipments to compete by selecting their respective random counters from 1 to q_1 for E-LBE1 and 1 to q_2 for E-LBE2, where q_1 and q_2 are chosen from the new proposed interval of backoff scaler ranging from 64 to 100.

For the results shown in Figure 5.7 and in Table 5.7, we fix the parameter q_2 of E-LBE2 to $q_2 = 64$ and vary q_1 of E-LBE1 along the whole interval from $q_1 = 64$ to $q_1 = 100$. The general observation on the channel access opportunities illustrated in Figure 5.7c, indicates that both two equipments get approximately equal chances on the channel. The imbalance of opportunities experienced there, comes from the random numbers chosen during backoff process which may be short or long. Note here that, these schemes follow the same backoff algorithm explained in Chapter 3.

Table 5.7 Numerical results of two E-LBEs with variable backoff scaler.

q1 of E-LBE1	64	65	66	67	68	69	70	71	72	73	74	75	76	77	78	79	80	81	82
E-LBE1	6	4	6	5	5	7	5	5	7	6	6	5	5	5	6	6	5	5	5
E-LBE2	4	6	4	5	5	3	5	5	3	4	4	5	5	5	4	4	5	5	5
FI index	0.962	0.962	0.962	1	1	0.862	1	1	0.862	0.962	0.962	1	1	1	0.962	0.962	1	1	1
q1 of E-LBE1	83	84	85	86	87	88	89	90	91	92	93	94	95	96	97	98	99	100	
E-LBE1	6	4	5	7	4	5	4	4	6	5	4	7	5	6	5	5	5	5	
E-LBE2	4	6	5	3	6	5	6	6	4	5	6	3	5	4	5	5	5	5	
FI index	0.962	0.962	1	0.862	0.962	1	0.962	0.962	0.962	1	0.962	0.862	1	0.962	1	1	1	1	
Average /10 Competitions																		0.9695	
Average /10 runs																		0.9533	

We extended the evaluation of this combination by the calculation of the FI using the same parameters for one run. We therefore, realized that, the FI gets closer to the maximum value with the average FI of 96.95% as shown in Figure 5.7c. By increasing the number of simulations to 10 runs and setting other q_2 values to $q_2=64$, 81 and 100, we realize also that the FI always remains bounded between 93% and 97%. Figure 5.7a illustrates the case where the FI is evaluated at $q_2=64$, 81 and 100. Respectively, these average FIs are calculated as 95.33%, 95.71% and 95.09% for 10 runs. Similar results are generated if either q_1 or q_2 is set to 100.

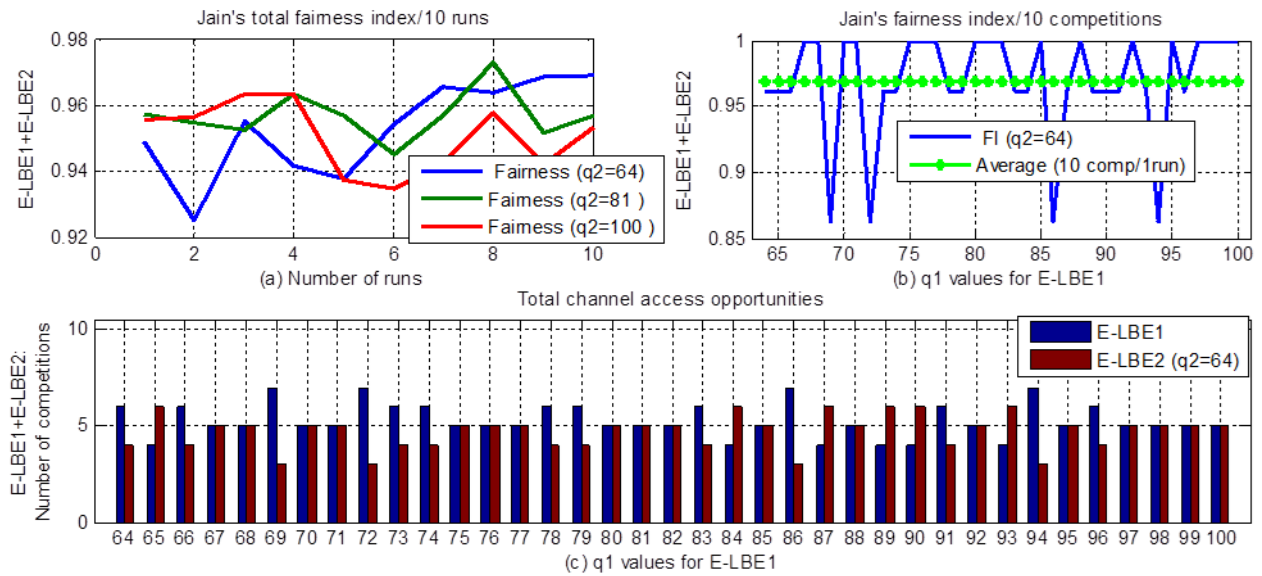

Figure 5.7 Channel opportunities & FI between two E-LBEs with variable backoff scaler.

5.2.2 Performance of the E-LBE and Wi-Fi schemes with variable backoff scaler

Another evaluated combination consists of E-LBE and Wi-Fi based schemes. For this pair, the assessment is done by varying q_1 parameter of E-LBE and fixing TxWi-Fi values. Here, we only extend CW of E-LBE by allowing it to select the q_1 values from the proposed interval (64 to 100). However, Wi-Fi CW remains unchanged because it follows exponential backoff mechanism which is different from that of E-LBE. Therefore, since the random counter for E-LBE is selected from 1 to q_1 ($q_1 \in [64, 100]$), it is likely possible for E-LBE to select large backoff counter, which give advantage to Wi-Fi scheme. Figure 5.8 and Table 5.8 illustrate results for these considerations.

An example of this consideration is shown at $q_1 = 92$ of Figure 5.8c, where Wi-Fi maximizes all the 10 competitions while E-LBE got zero. This is because E-LBE has chosen a large random counter (N) which in turn causes its CW to become wider and opens a large free space for Wi-Fi to decrement the counter easily. However, if E-LBE chooses shorter counter, it may get higher opportunities than Wi-Fi. This is the case for $q_1 = 75$, where Wi-Fi is found starved while E-LBE maximizes all the 10 chances. In general, although there are imbalances of chances for some individual q_1 values, it is shown that both schemes get opportunities on the channel.

Table 5.8 Numerical results of E-LBE and Wi-Fi with variable backoff scaler.

q1 of E-LBE1	64	65	66	67	68	69	70	71	72	73	74	75	76	77	78	79	80	81	82
E-LBE	3	7	6	5	7	5	4	8	8	4	4	10	9	6	3	4	8	3	8
Wi-Fi	7	3	4	5	3	5	6	2	2	6	6	0	1	4	7	6	2	7	2
FI_index	0.862	0.862	0.962	1	0.862	1	0.962	0.735	0.735	0.962	0.962	0.5	0.61	0.962	0.862	0.962	0.735	0.862	0.735
q1 of E-LBE1	83	84	85	86	87	88	89	90	91	92	93	94	95	96	97	98	99	100	
E-LBE	6	7	4	6	6	4	5	6	8	0	1	6	8	4	5	4	8	8	
Wi-Fi	4	3	6	4	4	6	5	4	2	10	9	4	2	6	5	6	2	2	
FI index	0.962	0.862	0.962	0.962	0.962	0.962	1	0.962	0.735	0.5	0.61	0.962	0.735	0.962	1	0.962	0.735	0.735	
Average /10 Competitions																		0.8567	
Average /10 runs																		0.828	

To have a general picture about the behaviours of these opportunities, we calculate the FI by considering the same parameter ($TxWiFi = 400 \mu s$). As shown in Figure 5.8b, the FI evaluated for a single run is shown to be almost stable even though there are some gaps, especially at $q_1 = 75$ and 92, because of the reason explained above. The average FI is calculated as 85.67%. We also extended the simulation to 10 rounds to demonstrate the general conclusion about this combination. However,

in this case, we consider different TxWiFi fixed to 400 μ s, 800 μ s and 1000 μ s. Therefore, by looking at the Figure 5.8a, we realize that the FI varies from 78% to 85%. This observation is also proved by the average FIs calculated as 82.80%, 81.43% and 80.53% computed when $TxWiFi = 400 \mu$ s, 800 μ s and 1000 μ s respectively. We have verified and realized that any change of TxWiFi has no impact on this observation.

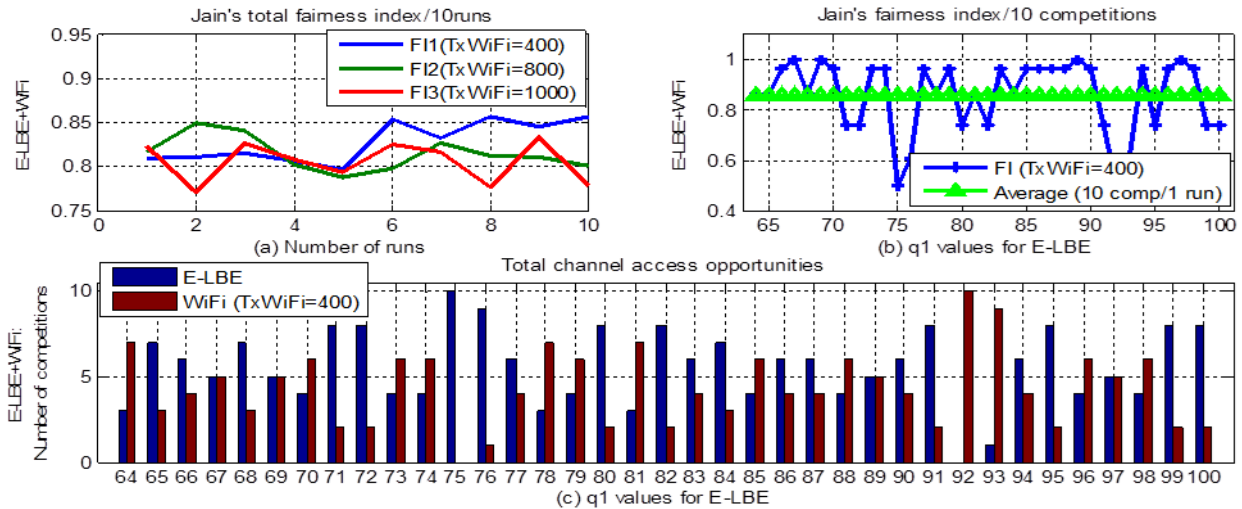

Figure 5.8 Channel opportunities and FI for E-LBE and Wi-Fi with variable backoff scaler.

5.2.3 E- LBE in hybrid scenario and other combinations

Although this E-LBE was found to produce better performance, we observed that the proposed range is not suitable for some combinations; where some schemes show poor performance or generate the same results like those generated for the original LBEs. The following are the average *FIs* evaluated for other remaining E-LBE combinations including hybrid scenarios. For these results, we set $TxWiFi = 400 \mu$ s and FBE's $CoT = 1000 \mu$ s for the combinations which do not involve the variation of these two parameters.

- For the combination of E-LBE and FBE, the performance is degraded with average FI varying from 50% to 53% when $q1$ is variable (64 to 100), whereas it varies from 50% to 51.5% for $q1=100$ and 64 respectively when FBE's CoT is variable.
- For E-LBE and Wi-Fi pair, when TxWiFi is variable, the FI varies between 81% and 84% for both $q1=64$ and 100.
- For hybrid scenario, when $q1$ is changing from 64 to 100, poor performance is generated with average FI varies from 45% to 47%. When FBE's CoT is variable, FI lies between 47% and 52%. Similarly, when TxWiFi is changing, the FI also degrades and varies between 37% and 40% for $q1 = 64$ and $q1 = 100$.

From these results, it can be seen that there is a big difference in performance when the new proposed range is considered, although this is not applied to all combinations.

5.3 Performance Comparison: 3GPP versus the Proposed Access Mechanisms

Having evaluated results of both 3GPP and the proposed access mechanisms, we now have a general overview about the performance of all combinations considered in this work. We have also mentioned previously that one of the main goals of this study is to investigate both mechanisms in order to look for parameters to consider for both access schemes, so that they can get equal opportunities in the shared band. Therefore, according to the above evaluation, this target can be indicated by the FI, which is supposed to be 100% for fair access mechanisms. Hence, in this section, we compare both access mechanisms through their respective combinations by targeting that FI of 100%. We consider only FI because it gives the globalized view of fairness between any pair or group of users competing for accessing the shared channel.

5.3.1 Discussion on the comparison process

The comparison presented here leads to the determination of the combinations with better performance representing a group of users on the channels. It is done by investing the behaviour of average (Avg) FIs for 3GPP and new proposed mechanisms. Here, we examine this performance combination-by-combination depending on the common parameter considered for both combinations being compared. However, there are some irregularities, where we have results of 3GPP mechanisms but no enhanced results shown. This is because there is no enhanced mechanism involved in those combinations under comparison. It is the cases of Wi-Fi+FBE, and FBE1+FBE2 for E-LBE-based mechanism; and LBE+Wi-Fi and LBE1+LBE2 for E-FBE-based mechanism. The absence of enhanced schemes is marked as NA (Not Applicable) in Table 5.9 which also shows a summary of all numerical results considered in this FI-based comparison.

Table 5.9 Summary of all numerical results generated based on FI.

(a) 3GPP mechanisms											
Combinations	FBE1+FBE2	LBE1+LBE2	LBE+FBE		LBE+Wi-Fi		Wi-Fi+FBE		Hybrid		
Parameters	CoT	q1	q1	CoT	q1	TxWiFi	TxWiFi	CoT	q1	CoT	TxWiFi
Average FI/ 1 run (%)	50.00	87.36	61.56	87.54	75.11	81.42	63.90	66.01	57.91	73.71	72.88
Average FI/ 10 runs (%)	50.00	87.81	62.24	92.12	76.00	82.78	65.66	66.56	57.67	76.89	75.34
(b) E-LBE-based mechanisms											
Combinations	E-LBE1 (NA)	E-LBE1+E-LBE2	E-LBE+FBE		E-LBE+Wi-Fi		FBE+Wi-Fi		Improved Hybrid		
Parameters	NA	q1	q1	CoT	q1	TxWiFi	q1	TxWiFi	q1	CoT	TxWiFi
Average FI/ 1 run (%)	NA	96.95	50.43	50.08	85.67	81.97	NA	NA	45.48	48.06	37.93
Average FI/ 10 runs (%)	NA	95.33	53.21	51.53	82.8	82.98	NA	NA	46.91	50.98	39.42
(c) E-FBE-based mechanisms											
Combinations	E-FBE1+E-FBE2	E-FBE1 (NA)	LBE +E-FBE		LBE+Wi-Fi		Wi-Fi+ E-FBE		Improved Hybrid		
Parameters	CoT	NA	q1	CoT	q1	TxWiFi	TxWiFi	CoT	q1	CoT	TxWiFi
Average FI/ 1 run (%)	96.70	NA	85.39	95.32	NA	NA	88.19	86.78	72.10	85.60	83.01
Average FI/ 10 runs (%)	97.27	NA	85.69	96.32	NA	NA	88.49	87.63	73.23	85.64	84.6

5.3.2 Performance comparison of 3GPP versus the E-LBE access mechanisms

Since we have various parameters applied differently on any given pair, we grouped the concerned combinations into cases depending on the common parameter used, which yielded a total of eight (8) cases for both E-LBE and E-FBE schemes. Their performance shown in terms of average IFs are illustrated in Table 5.10 and Figure 5.9. Different cases are evaluated and discussed individually as follows:

The CASE1 consists of the comparison of original LBE and E-LBE-based mechanisms. Regarding the combination to compare for this CASE1, it is important to remind that q1 parameter is selected from the interval ranging from 4 to 32, and from 64 to 100 for original LBE1 and E-LBE1 respectively. As show in Figure 5.9a and in Table 5.10, the average FI for a single simulation (one run) increases from 87.36% to 96.95%. When the simulation is extended to 10 runs, the average FI increases from 87.81% to 95.33% as illustrated in Figure 5.9b. Therefore, by globalizing the general observation for the combinations of this case (CASE1), E-LBE-based mechanism performs well in the proposed range (64 to 100) since the performance shows additional average FI of 9.59% for one run and 7.52% for 10 runs, compared to the original LBE scheme.

Similarly, CASE4 consists of the comparison between Wi-Fi combined with original LBE and E-LBE-based mechanism. In this case, E-LBE also shows an additional improvement of 10.56% and 6.80% for one run and 10 runs respectively, since their respective average FIs are 75.11% and 85.67% for one run, and 76.00% and 82.80% for 10 runs for both original and enhanced LBE-based mechanisms respectively. This is again shown in Figures 5.9 and in Table 5.10.

Table 5.10 Performance of 3GPP versus the E-LBE-based mechanisms.

Combinations to compare	Cases	Parameters	3GPP mechanisms		E-LBE-based mechanisms	
			Avg/1run	Avg/10runs	Avg/1run	Avg/10runs
LBE1+LBE2 vs. E-LBE1+E-LBE2	CASE1	q1	87.36	87.81	96.95	95.33
LBE+FBE vs. E-LBE+FBE	CASE2	q1	61.56	62.24	50.43	53.21
	CASE3	CoT	87.54	92.12	50.08	51.53
LBE+Wi-Fi vs. E-LBE+Wi-Fi	CASE4	q1	75.11	76.00	85.67	82.80
	CASE5	TxWiFi	81.42	82.78	81.97	82.98
Hybrid vs. Improved Hybrid	CASE6	q1	57.91	57.67	45.48	46.91
	CASE7	CoT	73.71	76.89	48.06	50.98
	CASE8	TxWiFi	72.88	75.34	37.93	39.42

Although, the performance is increased for the combinations of CASE1 and CASE4, all the remaining cases present poor performance. According to the Table 5.10, the combinations of CASE5 present average FIs of 81.42% and 81.97% for one run while for 10 runs they increase to 82.78% and 82.98% for the original LBE and E-LBE combinations respectively. However, the general observation indicates that there is only an improvement of 0.55% and 0.2% for one run and 10 runs respectively. Meaning that, the performance of CASE5 remains bounded to that generated for original LBE combination, i.e, the performance remains nearly the same for both improved and original schemes. Hence, for CASE5, all mechanisms consisting of either LBE or E-LBE produces the same results when q1 is selected either from 4 to 32 or from the new proposed range (64 to 100), as shown in Figure 5.9. Therefore, for avoiding the complexity and long delays of data transmission, we can keep the original range (4 to 32) for LBE-based mechanism in LTE-U band.

In addition to this, the performance of E-LBE in the new range for the remaining cases decreases dramatically to very low levels. By comparing the corresponding combinations for every case (both original LBE and E-LBE-based mechanisms), we observe that the performance shown in terms of average FIs degrades as follows:

- CASE2: the performance is reduced by 11.13% for one run and by 9.03% for 10 runs.
- CASE3 shows a degradation of performance by 37.46% for one and 40.59% for 10 runs.
- CASE6 shows a degradation of performance by 12.43% for one and 10.76% for 10 runs.
- CASE7 shows a degradation of performance by 25.65% for one and 25.91% for 10 runs.
- CASE8 shows a degradation of performance by 34.95% for one and 35.92% for 10 runs.

This performance degradation is also illustrated in Figure 5.9 with numerical results shown in Table 5.10. Due to this poor performance, E-LBE is not suitable for LTE-U mechanism in the new proposed range. Hence, the range 4 to 32 has to be kept for all LBE-based mechanisms in the LTE-U band.

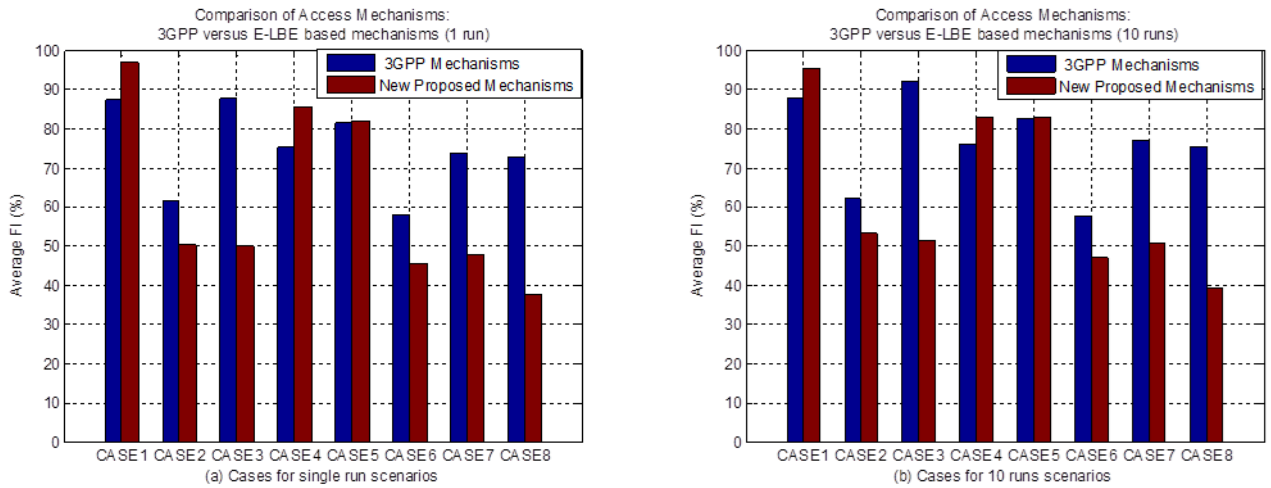

Figure 5.9 Performance comparison: 3GPP versus E-LBE-based schemes.

5.3.3 Performance comparison of 3GPP versus the E-FBE-based mechanisms

Similar to the E-LBE, we also group combinations to be compared into eight cases (8) for enhanced FBE. CASE1 consisting of comparison of original FBE and E-FBE performance, is shown as special case of this comparison, because it considerably increased the performance of this combination by almost 50% (47.27%). And this is because; the simulation of original FBEs showed that, for the implemented asynchronous scheme, only one equipment which has accessed the channel first occupies it and gets all opportunities (for 10 competitions considered). This causes this FBE1+FBE2 combination to have average FI of 50%. However, this weakness, together with the experienced problem of collisions, are solved by using E-FBE, which increases the average FI to 96.70% and 97.27% for one run and 10 runs respectively. Meaning that, the performance has also increased by 46.70% and 47.27% for one and 10 runs respectively. Table 5.11 and Figure 5.10 show the comparative average FIs of the E-FBE with other 3GPP LTE-U mechanisms.

On the other hand, if the performance of the E-FBE is compared to that of the original LBE-based mechanism (LBE1+LBE2 vs E-FBE1+E-FBE2), also the average FI is shown to increase by 9.34% for a single run and by 9.46% for 10 runs (for original LBE, average FI = 87.36% for one run and 87.81% for 10 runs); indicating that the E-FBE-based mechanism can fairly coexist with original LBE as well as other E-FBE-based mechanisms.

Table 5.11 Numerical results of 3GPP versus E-FBE-based mechanisms.

Combinations to compare	Cases	Parameters	3GPP mechanisms		E-FBE-based mechanisms	
			Avg/1 run	Avg/10 runs	Avg/1 run	Avg/10 runs
FBE1+FBE2 vs. E-FBE1+E-FBE2	CASE1	CoT	50.00	50.00	96.70	97.27
LBE+FBE vs. LBE +E-FBE	CASE2	q1	61.56	62.24	85.39	85.69
	CASE3	CoT	87.54	92.12	95.32	96.32
Wi-Fi+FBE vs. Wi-Fi+ E-FBE	CASE4	TxWiFi	63.9	65.66	88.19	88.49
	CASE5	CoT	66.01	66.56	86.78	87.63
Hybrid vs. Improved Hybrid	CASE6	q1	57.91	57.67	72.10	73.23
	CASE7	CoT	73.71	76.89	85.60	85.64
	CASE8	TxWiFi	72.88	75.34	83.01	84.60

For the combinations of all the remaining cases, the general observation indicates that the performance of E-FBE-based mechanism increases compared to that of the original FBE schemes, depending upon the common parameter considered for the concerned combination. Therefore, by comparing case-by-case and by considering a single and 10 runs performed during Matlab simulation, the increased E-FBE performance resulted from the average FIs is demonstrated as follows:

- CASE2: the performance increases by 23.83% for a single run and by 23.45% for 10 runs.
- CASE3: the performance increases by 7.78% for a single run and by 4.2% for 10 runs.
- CASE4: the performance increases by 24.29% for one run and by 22.83% for 10 runs.
- CASE5: the performance increases by 20.77% for one run and by 21.07% for 10 runs.
- CASE6: the performance increases by 14.19% for a single run and by 15.56% for 10 runs.
- CASE7: the performance increases by 11.89% one run and by 8.75% for 10 runs.
- CASE8: the performance increases by 10.13% for a single run and by 9.26% for 10 runs.

This performance is also illustrated in Figure 5.10a and 5.10b, where the new proposed E-FBE-based mechanism shows the highest levels of performance than the original FBE-based mechanisms. And in general, the main reason lies in the fact that the original FBE-based mechanism initiated by 3GPP has no backoff mechanism. As it was explained; this made FBE to be the winner almost all the times due to their original CCA. But for these E-FBE-based combinations, all mechanisms follow the backoff mechanism, which can give advantages to every scheme to have chances on the channel. Hence, the performance is increased.

Moreover, by comparing E-FBE and E-LBE-based mechanisms, we observed that E-LBE schemes have poor performance over E-FBE schemes, since for E-LBE, most of the combinations suffer while others perform well. For the sake of best fairness as our target in the studied LTE-U mechanisms, this performance degradation causes E-LBE-based mechanism to not be suitable for LTE-U band. On the other hand, for E-FBE, all combinations increase the performance in all combinations, including hybrid scenarios, which makes it to be better suitable in that LTE-U band.

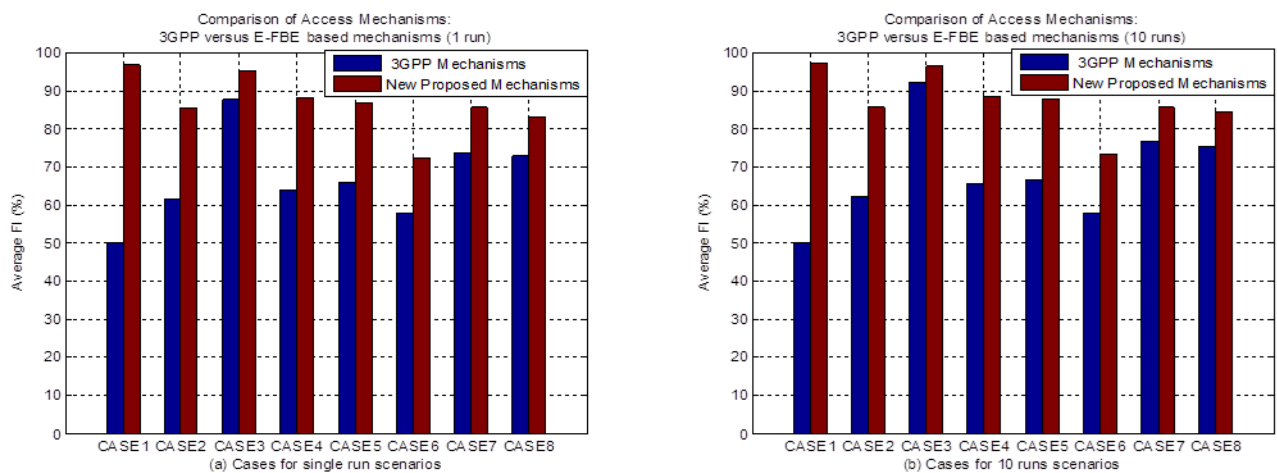

Figure 5.10 Performance comparison: 3GPP versus the E-FBE-based schemes.

5.4 Chapter Summary

In this chapter, we presented details about the generated results of the proposed access mechanisms, such as backoff mechanism for original FBE scheme, and the extension of CW size for original LBE-based mechanism. The general observation indicates that E-FBE-based combinations present better performance in most cases since all involved equipments can get relatively larger number of access opportunities on the shared channel. This is because all schemes in any combinations depend on the backoff algorithm during competition. Hence, depending upon the

chosen random counter, every equipment may get room for decrementing its random counter which also increases chances of accessing the channel and transmissions. This is also indicated by the FI calculated throughout this results presentation which is relatively high. This performance parameter (FI) is very important because it gives the general picture of fairness for the whole combination under consideration. By recalling one of our main targets of allocating equal channel resources to users, this parameter helps us to know how fair those resources are allocated to them on the shared band.

We also presented another proposed backoff mechanism (E-LBE) consisting of extending the CW size of original LBE-based mechanism. And this is done by extending the interval of q_1 values; originally selected from 4 to 32. However, the new proposed interval of the E-LBE schemes ranges from 64 to 100. The reason behind this CW extension is to allow other competitors to have a large free space for decrementing their backoff counters. For example, Wi-Fi which in most of time gets least chances will perform well if the new range is applied. We also demonstrated that the performance of E-LBE is better, although it is not applied to all combinations considered in this work.

We have also compared the performance of the two proposed access mechanisms. This comparison is done by considering only the average FIs for both schemes, including 3GPP and proposed mechanisms. This is because FI shows the general observation of the whole combination, in terms of fairness, as it is our target towards the best coexistence of all mechanisms in the LTE-U band. Regarding this comparison, we have observed that only few combinations for E-LBE-based schemes can perform well, where the performance has increased by 9.59% and 10.56% for the combinations with other E-LBE and Wi-Fi respectively (for a variable q_1). However, other combinations, including hybrid scenarios, degrade the performance up to 37.46%. On the other hand, for all combinations of E-FBE-based mechanism, the performance increases in every considered case up to 47.27%. And because of this increase in performance, the E-FBE schemes are found to be the best suitable mechanisms to consider in the LTE-U band whereas E-LBE is not, due to its performance degradation observed in some of its combinations.

6 Conclusions and Future Work

After analyzing the studied LTE-U mechanisms, both 3GPP and the newly proposed mechanisms, we now present the concluding observations in this chapter. These conclusions are drawn from the comparative analysis of the LAA-based LBT mechanisms proposed by 3GPP to operate in the shared LTE-U band of 5 GHz. Different parameters were used to examine the feasibility of this coexistence in that band. However, given our main target in this work, it has been found that the performance of some mechanisms is very poor which trigger our motivation to propose the new mechanisms. And the enhanced mechanisms demonstrated the improved performance compared to that showed by the original mechanisms initiated by 3GPP. All these points are briefly summarized here in this chapter together with contributions made by this thesis as well as the proposed future work.

6.1 Conclusions

In response the current demand of additional capacity in the shared band, the basic and very important starting point is the study of coexistence feasibility of LTE-U MAC mechanism, which was also another challenge for both LAA-based LBT mechanism as well as Wi-Fi-based mechanism in the shared band. Also, to allow users to have equal opportunities on the shared channel, fairness between both mechanisms has been investigated through a comparative analysis of results. In this study, we considered different parameters which directly reflect the frame size (or transmission time) variation. Therefore, we investigated the fairness behaviours of the access mechanisms in the shared channel if frame size (or transmission time) is fixed or made variable depending on the scenarios. This is an idea adopted from the initiated adaptive LAA-based mechanisms by 3GPP.

By using Matlab simulation, we have generated results related to the mechanisms originally proposed by 3GPP; investigate them to check their possibility of supporting fair access effective coexistence between the examined mechanisms in the shared band. However, the assessment demonstrated that some access mechanisms have definite access to the channel while other are completely blocked. For example, the equipment using FBE-based mechanism was shown to always occupy the channel, and to have more opportunities than others. In some cases, a Wi-Fi-based scheme is starved with very less (or no) chances on the channel. Hence, by evaluating the fairness under these conditions, Jain's FI showed a poor performance in terms of average FI which remains bounded to almost 50% when there is a competition of two users and 33.33% for hybrid scenario; indicating an ineffective coexistence and unfair access of these mechanisms. Note here that, the target for fairness was to achieve FI by almost 100%. We have discovered that the reason of this poor performance is caused mainly by the short CCA sensing period of FBE-based mechanism, since it is applied once for deciding the transmission (transmit or not depending on CCA successfulness), while others LBE and Wi-Fi-based mechanism are still decrementing their respective counters. It has been shown that the problem is worsened if FBE's frame size is long, since other mechanisms have to wait for long time. Hence, FBE-based mechanisms can have more opportunities on the channel.

In addition to this, if only FBE-based equipments are contending for the channel access, they prone to serious collisions if they are synchronized. On the other hand, if they are asynchronous, one of them gets maximum of the channel opportunities, while another is completely starved which also degrades the FI (i.e, the average FI remains bounded to lower level). Again, this is because of equal CCA sensing time possessed by FBE-based mechanisms. In our simulation we limited the trials to 10 competitions, and then evaluate the share (out of 10) of every access mechanism engaged into competitions along the range (M) of the considered parameter.

For achieving the target (FI by almost 100%) and addressing the problem of inefficient coexistence and unfairness experienced during the simulation of 3GPP mechanisms, we have proposed two newly insights which showed the improved performance; one for enlarging the CW size for LBE-based mechanism (E-LBE), and another one consisting introducing backoff mechanism for FBE-based mechanism (E-FBE). By comparing the performance of these proposed mechanisms with the

original mechanisms proposed by 3GPP, we observed that two cases (CASE1 and CASE4) of LBE-based combinations, namely E-LBE+E-LBE and E-LBE+Wi-Fi, perform well and increases the average FI up to 10.56% (see Figure 5.9 and Table 5.10). However, the performance of others of other combinations degrades, even up to 37.46%. Considering our target, this indicates that the fairness and coexistence for the equipment using E-LBE is not useful at all due to that degradation of performance. On the other hand, E-FBE-based schemes showed a reasonable increase of performance in all involved combinations. For this mechanism, the increase in average FI is counted from 7.78% to 47.27% when FI is considered in all combinations. Indicating that, the opportunity to the channel access has also increased in all mechanisms employing E-FBE schemes.

Therefore, the performance of E-FBE demonstrated the increase of FI in E-FBE-based mechanism indicates also the fairness between the access mechanisms on the shared channel; which in turn, announces the possibility of fair access and effective coexistence of these mechanisms in that LTE-U band. Hence, the E-FBE-based mechanism is the most suitable mechanism to operate in the LTE-U band, since it increases the performance in all combinations and solves the problem of collisions and selfishness, which originally are experienced between combinations made by only FBE-based mechanisms in cases of synchronous and asynchronous scenarios. On the other hand, the E-LBE-based mechanisms are not suitable to be applied in the shared band, since their performance is considerably degraded in most of the combinations including hybrid scenarios. Hence, given the work done and by recalling the above-mentioned goals of this thesis, we can confirm that all goals are achieved.

Moreover, regarding the high demanding for addition bandwidth, users will have benefits from that coexistence and co-operation of Wi-Fi and LTE in the shared 5 GHz band; since they will be happy to have equal opportunities and the fairest access on channel despite the current increasing number of sophisticated equipments.

6.2 Contributions

The main contributions made by this thesis work are summarized as follows:

- Two popular MAC mechanisms proposed by 3GPP have been implemented.
- Based on implementations, extensive simulations are performed to evaluate the performance of these two schemes.
- Channel access opportunities have been determined for both 3GPP and proposed schemes.
- The Jain's FI has been extended and at the same time applied to multi-competition scenarios for the performance evaluation.
- An improved LBE-based mechanism consisting of the CW size extension has been proposed. This was fulfilled by setting a new range from which the backoff scaler (q) is selected.
- An improved FBE which consists of introducing the backoff mechanism to the original FBE has been proposed.
- Implementation of the proposed MAC mechanisms and their comparison with 3GPP mechanisms have been done for determining the best mechanism suitable in the LTE-U band.

6.3 Future Work

Throughout this thesis, we mainly focussed on the fairness between the LTE-U access mechanisms by only considering the channel access opportunities. However, it is also possible to verify this fairness by taking into account of delays and throughput for LTE-U equipments operating in the shared band. Also, this work is limited to DCF algorithm. It therefore important to verify this coexistence feasibility by considering EDCA, which originally was designed to give more chances to high priority MAC mechanisms through the provision of shorter Arbitration Inter-frame Space (AIFS). For the Future work, this AIFS can be modified in order to achieve a fair coexistence. The final suggestion is the consideration of RTS/CTS in LTE-U mechanism for avoiding the impact of hidden and exposed terminals.

References

- [1] Qualcomm Incorporated, "LTE in Unlicensed Spectrum : Harmonious Coexistence with Wi-Fi," *White Paper*, San Diego, pp. 1–19, Jun. 2014.
- [2] ETSI EN 301893, "Broadband Radio Access Networks: Harmonized European Standard," *Technical Report*, vol. v1.7.1, Sophia Antipolis Cedex, pp. 1–26, Jun. 2012.
- [3] Signals Research Group, "The Prospect of LTE and Wi-Fi Sharing Unlicensed Spectrum," *White Paper*, Oakland, pp. 1–17, Dec. 2014.
- [4] 3GPP-TR36.889, "Study on Licensed-Assisted Access to Unlicensed Spectrum," *Technical Report*, vol. 1.1, no. Release 13, Sophia Antipolis, pp. 1–40, Nov. 2014.
- [5] Alcatel-lucent-Shanghai Bell and Alcatel-Lucent, "LBT Requirements and Required Functions for LAA," *3GPP TSG RAN WG1 Meeting #78bis, R1-144083*, no. 7.3.2.3, Ljubljana, pp. 1–6, Aug. 2014.
- [6] A. M. Cavalcante, E. Almeida, R. D. Vieira, F. Chaves, R. C. D. Paiva, F. Abinader, S. Choudhury, E. and Tuomaala, and K. Doppler, "Performance evaluation of LTE and Wi-Fi coexistence in unlicensed bands," *77th IEEE VTC*, Dresden, pp. 1–6, Jun. 2013.
- [7] E. Almeida, A. M. Cavalcante, R. C. D. Paiva, F. S. Chaves, F. M. Abinader, R. D. Vieira, S. Choudhury, E. Tuomaala and K. Doppler, "Enabling LTE/WiFi Coexistence by LTE Blank Subframe Allocation," *IEEE ICC*, Budapest, pp. 5083–5088, Jun. 2013.
- [8] Z. Haijun, C. Xiaoli, G. Weisi, and W. Siyi, "Coexistence of Wi-Fi and Heterogeneous Small Cell Networks Sharing Unlicensed Spectrum," *IEEE Communications Magazine*, vol. 53, no. 3, pp. 158–164, Mar. 2015.
- [9] J. Ling, S. Kanugovi, S. Vasudevan, and A. K. Pramod, "Enhanced Capacity and Coverage by Wi-Fi LTE Integration," *IEEE Communications Magazine*, vol. 53, no. 3, pp. 165–171, Mar-2015.
- [10] Ericsson, Qualcomm and Huawei, "Study on Licensed-Assisted Access using LTE," *3GPP TSG RAN Meeting#65, RP-141397*, Edinburgh, pp. 1–8, Sep. 2014.
- [11] T. Nihtila, V. Tykhomyrov, O. Alanen, M. a. Uusitalo, A. Sorri, M. Moisio, S. Irajai, R. Ratasuk and N. Mangalvedhe, "System Performance of LTE and IEEE 802.11 Coexisting on a Shared Frequency Band," *IEEE WCNC*, Shanghai, pp. 1038–1043, Apr. 2013.
- [12] R. D. V. Fuad M. Abinader, Jr., Erika P. L. Almeida, Fabiano S. Chaves, André M. Cavalcante, K. D. Rafael C. D. Paiva, Angilberto M. Sobrinho, Sayantan Choudhury, Esa Tuomaala and J. Vicente A. Sousa, "Enabling the Coexistence of LTE and Wi-Fi in Unlicensed Band," *IEEE Communications Magazine*, vol. 52, no. 11, pp. 54–61, Nov. 2014.
- [13] Qualcomm Incorporated, "Solutions for Required Functionalities and Design Targets," *3GPP TSG RAN WG1 #78bis, R1-144000*, Ljubljana, pp. 1–5, Oct. 2014.
- [14] A. Babaei, J. Padden and J. Andreoli-fang, "Overview of EU LBT and its Effectiveness for Coexistence of LAA LTE and Wi-Fi," *IEEE 802.19-14/0082r0*, Louisville, pp. 1–11, Nov. 2014.

- [15] Ericsson, "Further Details on LBT for LAA," *3GPP TSG RAN WG1 Meeting #80, R1-150584*, Athens, pp. 1–6, Feb. 2015.
- [16] M. Bernie, M. Kyung and A. Rob, "LTE-Unlicensed: Augmenting Mobile Data Capacity, But Coexistence Needs Consideration," *Technical Report*, pp. 1–15, 2013.
- [17] F. Teng, D. Guo and M. L. Honig, "Sharing of Unlicensed Spectrum by Strategic Operators," *IEEE GlobalSIP*, Atlanta, GA, pp. 288–292, Dec. 2014.
- [18] Alcatel-Lucen and Alcatel-Lucent Shanghai Bell, "Required Functionalities and Design Targets for Licensed-Assisted Access Using LTE," *3GPP TSG RAN WG1 Meeting #78bis, R1-144080*, Ljubljana, pp. 1–3, Oct. 2014.
- [19] Q. Zhao, W. Ren and A. Swami, "Spectrum Opportunity Detection: How Good is Listen-Before-Talk?," *41st IEEE ACSSC*, Pacific Grove, pp. 767–771, Nov. 2007.
- [20] S. Huang, S. Huang, X. Liu, X. Liu, Z. Ding and Z. Ding, "On Optimal Sensing and Transmission Strategies for Dynamic Spectrum Access," *3rd IEEE International Symposium on New Frontiers in DySPAN*, Chicago, pp. 1–5, Oct. 2008.
- [21] A. K. Sadek, W. Zhang and S. J. Shellhammer, "Listen-Before-Talk Versus Treating Interference as Noise for Spectrum Sharing," *3rd IEEE Symposium on New Frontiers in DySPAN*, Chicago, pp. 1–6, Oct. 2008.
- [22] A. Al-dulaimi, S. Al-rubaye, Q. Ni and E. Sousa, "5G Communications Race: Pursuit of More Capacity Triggers LTE in Unlicensed Band," *IEEE Vehicular Technology Magazine*, vol. 10, no. 1, pp. 43–51, Mar. 2015.
- [23] Nokia, "LTE for Unlicensed Spectrum," *White Paper*, Espoo, pp. 1–11, 2014.
- [24] Huawei Technology Co. Ltd, "U-LTE : Unlicensed Spectrum Utilization of LTE," *White Paper*, pp. 1–20, 2014.
- [25] A. Bin Sediq, R. H. Gohary and H. Yanikomeroğlu, "Optimal Tradeoff between Efficiency and Jain ' s Fairness Index in Resource Allocation," *IEEE Transactions on Wireless Communications*, vol. 12, no. 7, Sydney, pp. 3486–3509, Sep. 2012.
- [26] G. Bianchi, "Performance Analysis of the IEEE 802.11 Distributed Coordination Function," *IEEE Journal on Selected Areas in Communications*, vol. 18, no. 3, pp. 535–547, Mar. 2000.
- [27] H. W. H. Wu, Y. P. Y. Peng, K. L. K. Long, S. C. S. Cheng and J. M. J. Ma, "Performance of Reliable Transport Protocol over IEEE 802.11 Wireless LAN: Analysis and Enhancement," in *Proc. 21st IEEE /INFOCOM*, vol. 2, no. c, pp. 599–607, 2002.
- [28] O. Tarasyuk, A. Gorbenko and T. Hollstein, "Contention Window Adaptation to Ensure Airtime Consumption Fairness in Multirate Wi-Fi Networks," *10th IEEE international Conference on Digital Technology*, Zilina, pp. 344–349, Jul. 2014.
- [29] Coolpad, "Discussion on the Comparison of LBE and FBE for LBT," *3GPP TSG RAN WG1 Meeting#79, R1-145132*, San Francisco, pp. 1–5, Nov. 2014.
- [30] ETRI, "Generalized Energy Transmission Field for LBT and Back-off based Co-channel," *3GPP TSG-RAN1#78b , R1-143964*, Ljubljana, pp. 1–3, Oct. 2014.

Appendices

Appendix A Additional Results based on the 3GPP MAC Mechanisms

In addition to the results presented in Chapter 4, we present more results for more clarifications.

A.1 LBE1+LBE2 (q2=4, and q1 ∈ [4, 32])

The following are the additional results of LBE1+LBE2 combination where both LBEs can have nearly equal opportunities when the values of the variable q1 is closing to the fixed q2=4. Also, as q1 is getting larger, LBE1 is starved since LBE2 will have the shortest CW size ($N \in [1, q2]$).

Table A.1.1 Numerical Results of LBE1+LBE2 with variable backoff scaler q1 (q2=4).

q1 values	4	5	6	7	8	9	10	11	12	13	14	15	16	17	18
LBE1	5	4	4	3	2	2	3	2	2	2	1	2	1	1	1
LBE2	5	6	6	7	8	8	7	8	8	8	9	8	9	9	9
FI_index	1	0.962	0.962	0.862	0.735	0.735	0.862	0.735	0.735	0.735	0.61	0.735	0.61	0.61	0.61
q1 values	19	20	21	22	23	24	25	26	27	28	29	30	31	32	
LBE1	2	2	1	1	0	1	0	0	1	0	1	2	1	0	
LBE2	8	8	9	9	10	9	10	10	9	10	9	8	9	10	
FI index	0.735	0.735	0.61	0.61	0.5	0.61	0.5	0.5	0.61	0.5	0.61	0.735	0.61	0.5	
Average /10 Competitions													0.6849		
Average /10 runs													0.69		

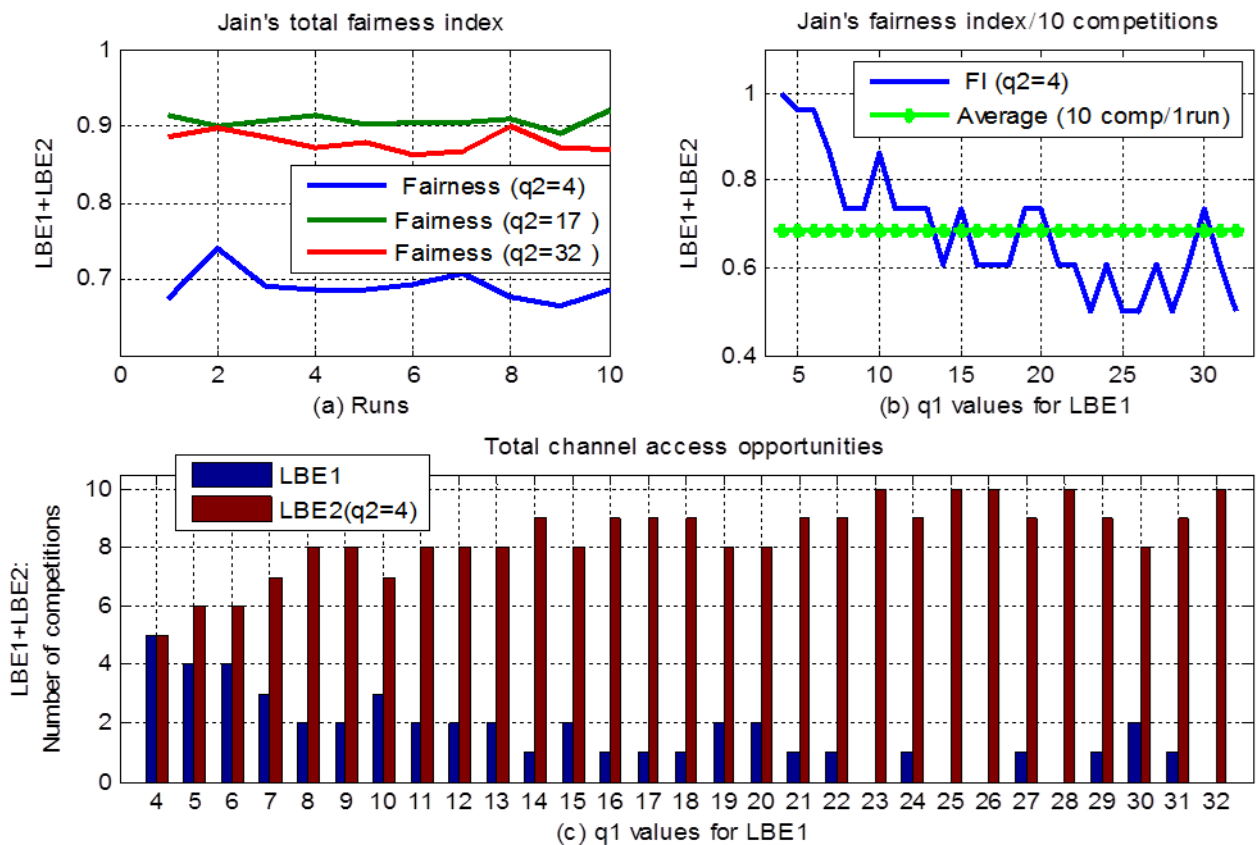

Figure A.1.1 Access opportunities and FI for LBE1+LBE2 with variable backoff scaler q1 (q2=4).

A.2 LBE+Wi-Fi (TxWiFi is fixed and $q_1 \in [4, 32]$)

In this results, the FI remains bouded to average $FI = 76\%$. And this is calculated at fixed $TxWiFi = 400 \mu s$ and for the variable q_1 parameter. We also evaluated FI for $TxWiFi = 800 \mu s$ and $TxWiFi = 1000 \mu s$ with q_1 variable. However, it is shown that the variation of $TxWiFi$ has no effect on the general obsevation for this combination since the average FI remains in the same range.

Table A.2.1 Numerical Results of LBE+Wi-Fi with variable backoff scaler q_1 ($TxWiFi=400 \mu s$).

q1 values	4	5	6	7	8	9	10	11	12	13	14	15	16	17	18
LBE1	10	8	7	9	7	7	8	8	7	9	8	5	9	7	7
WiFi	0	2	3	1	3	3	2	2	3	1	2	5	1	3	3
FI index	0.5	0.735	0.862	0.61	0.862	0.862	0.735	0.735	0.862	0.61	0.735	1	0.61	0.862	0.862
q1 values	19	20	21	22	23	24	25	26	27	28	29	30	31	32	
LBE1	8	8	9	5	9	9	9	8	3	8	7	2	5	10	
WiFi	2	2	1	5	1	1	1	2	7	2	3	8	5	0	
FI index	0.735	0.735	0.61	1	0.61	0.61	0.61	0.735	0.862	0.735	0.862	0.735	1	0.5	
Average /10 Competitions													0.7511		
Average /10 runs													0.76		

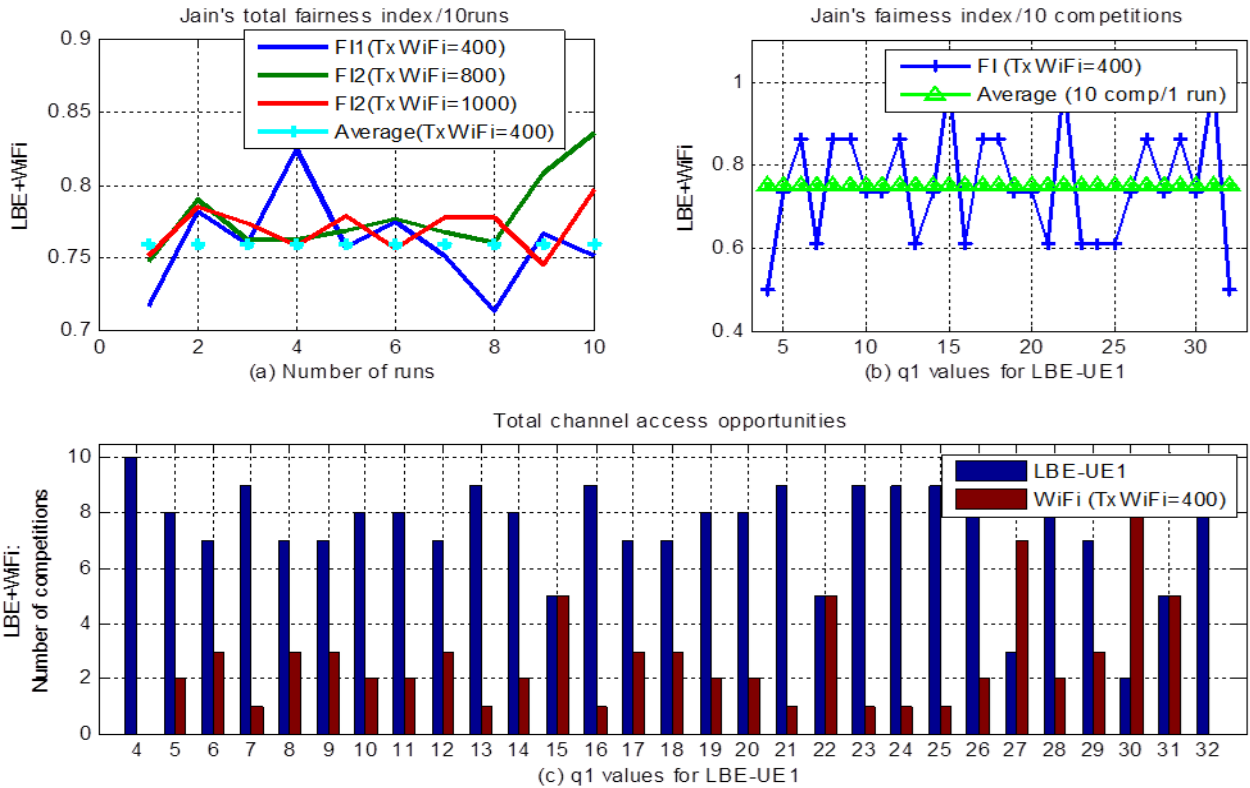

Figure A.2.1 Access opportunities and FI for LBE+Wi-Fi with variable backoff scaler q_1 ($TxWiFi=400 \mu s$).

A.3 LBE+FBE (CoTs fixed and $q_1 \in [4, 32]$)

The results for this combination evaluated at FBE's $CoT = 1000 \mu s$, $CoT = 5000 \mu s$ and $CoT = 10000 \mu s$ indicate that there is no impact of CoT when q_1 is variable, for this combination. Only q_1 shows the variation of FI and channel access opportunities. That is, for smaller q_1 , FI increases since LBE can select shorter random counter (N) and benefits from idle periods of FBE, while it is starved as q_1 parameter gets larger. In this case, N can be high and opens rooms for FBE, which always win.

Table A.3.1 Numerical Results of LBE+FBE with variable backoff scaler q1 (TxWiFi=400μs & CoT = 1000 μs).

q1 values	4	5	6	7	8	9	10	11	12	13	14	15	16	17	18
LBE	4	3	2	2	2	3	1	3	0	1	0	1	1	0	1
FBE	6	7	8	8	8	7	9	7	10	9	10	9	9	10	9
FI_index	0.962	0.862	0.735	0.735	0.735	0.862	0.610	0.862	0.500	0.610	0.500	0.610	0.610	0.500	0.610
q1 values	19	20	21	22	23	24	25	26	27	28	29	30	31	32	
LBE1	0	0	0	1	0	0	1	0	1	1	0	0	1	0	
LBE2	10	10	10	9	10	10	9	10	9	9	10	10	9	10	
FI index	0.500	0.500	0.500	0.610	0.500	0.500	0.610	0.500	0.610	0.610	0.500	0.500	0.610	0.500	
Average /10 Competitions														0.6156	
Average /10 runs														0.6224	

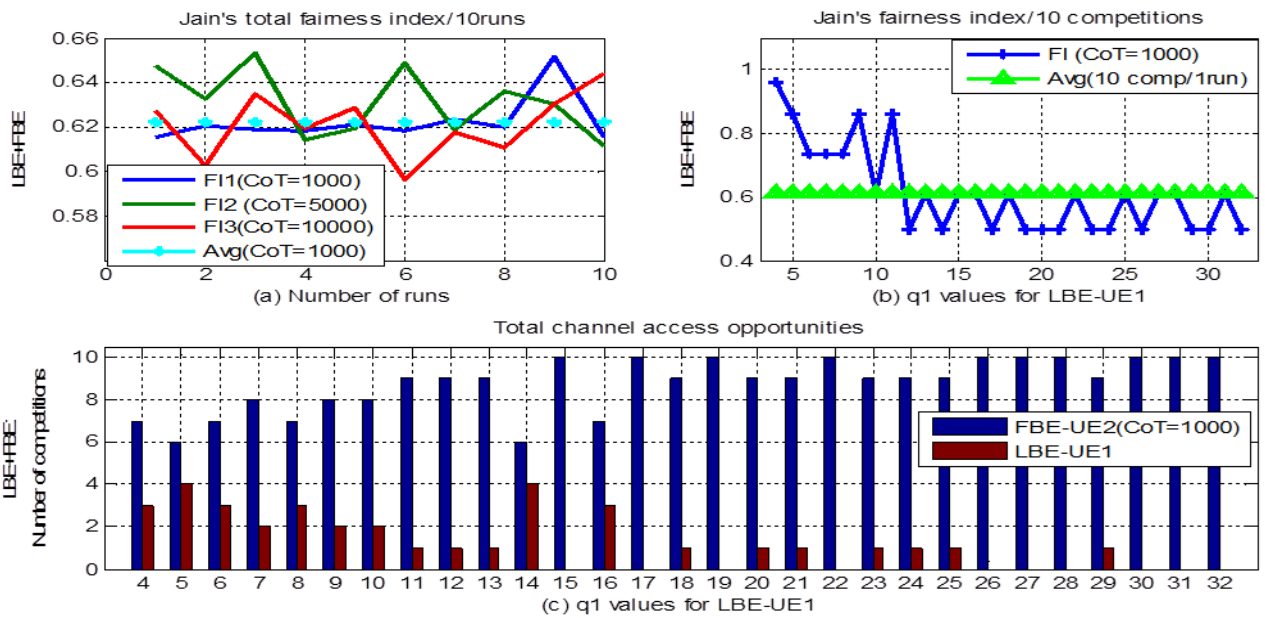

Figure A.3.1 FI in LBE+FBE pair with variable backoff scaler q1 (TxWiFi=400 μs & CoT = 1000 μs).

A.4 FBE1+ FBE2 (CoT2=1000 μs and CoT1 ∈ [1 ms , 10 ms])

These results show how FBE2 is completely blocked in a combination of two FBES, since they are asynchronous, when one of the channel occupancy (CoT1) is variable. Note also that they simultaneously sense the channel by using the same $CCA \geq 20 \mu s$. Hence, only the equipment which accesses the channel first maximizes opportunities with average FI kept at 50%. It has been also shown that, if they are synchronous, they lead to severe collisions.

Table A.4.1 Numerical results of FBE1+FBE2: Only FBE1 maximizes opportunities

CoT1	1000	2000	3000	4000	5000	6000	7000	8000	9000	10000
FBE1	10	10	10	10	10	10	10	10	10	10
FBE2	0	0	0	0	0	0	0	0	0	0
FI index	0.5	0.5	0.5	0.5	0.5	0.5	0.5	0.5	0.5	0.5
Average /10 Competitions										0.5
Average /10 runs										0.5

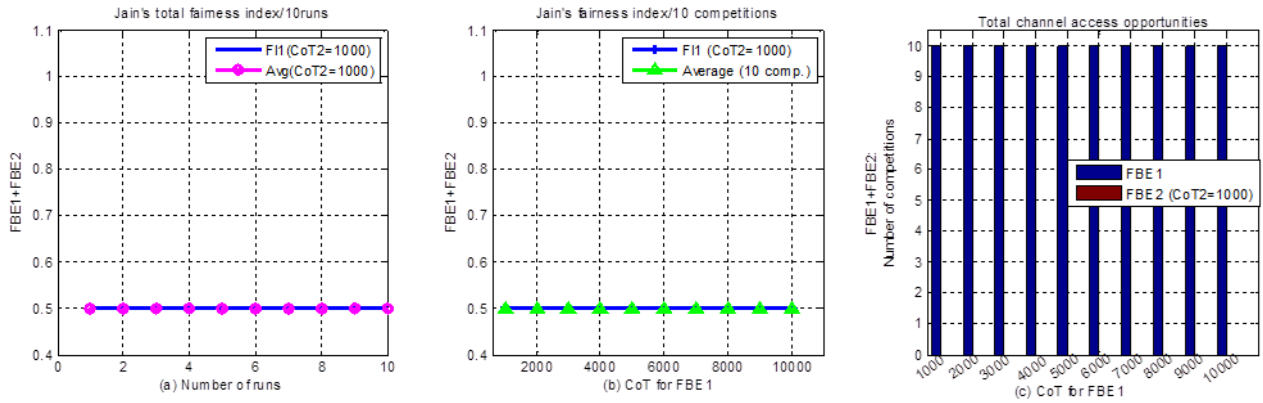

Figure A.4.1 Performance of FBE1+FBE2: Only FBE1 maximizes opportunities (No chance for FBE2)

A.5 FBE+Wi-Fi (TxWiFi fixed and CoT ∈ [1 ms , 10 ms])

These results are shown when TxWiFi is set to 400 μs with variable FBE's CoT. The general observation indicates that, the FI oscillates between 64% to 77% (average FI=66.01% is calculated at TxWiFi = 400 μs). Wi-Fi opportunities are considerably degraded because the CCA (20 μs) for FBE is shorter compared to DIFS (34μs). Also, while Wi-Fi is decrementing its random counter, FBE can transmit. Wi-Fi only has chances to transmit within idle periods of FBE.

Table A.5.1 Numerical results of FBE+Wi-Fi with variable FBE's CoT (TxWiFi=400 μs).

CoT	1000	2000	3000	4000	5000	6000	7000	8000	9000	10000
FBE	9	8	9	9	9	8	7	9	9	9
Wi-Fi	1	2	1	1	1	2	3	1	1	1
FI index	0.61	0.735	0.61	0.61	0.61	0.735	0.862	0.61	0.61	0.61
Average /10 Competitions									0.6601	
Average /10 runs									0.6656	

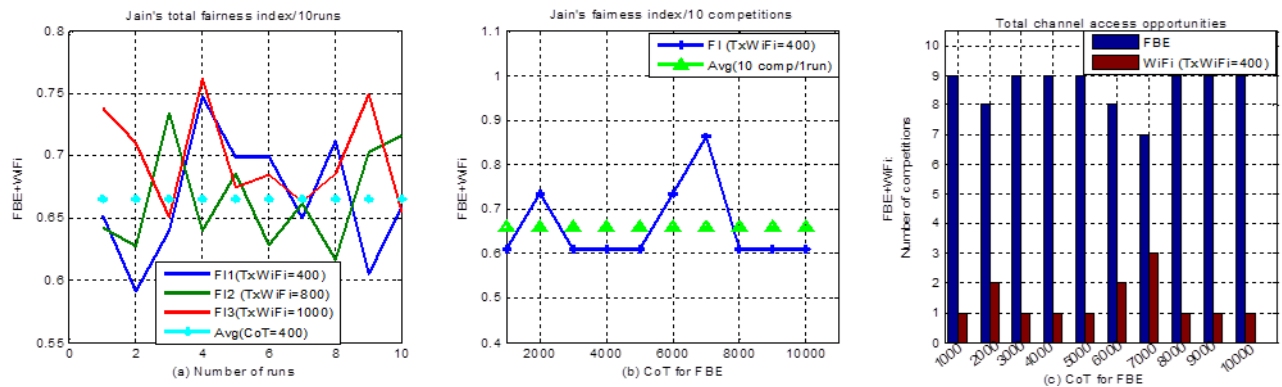

Figure A.5.1 Access opportunities in FBE+Wi-Fi pair with variable FBE's CoT (TxWiFi=400μs).

A.6 LBE+FBE+Wi-Fi (q=32, TxWiFi∈[400 μs ,2400 μs] and CoT2=1000 μs)

The following results show the hybrid scenario where channel opportunities are calculated at q1=32 and CoT of FBE fixed 1000 μs with variable TxWiFi. Since FBE doesn't follow backoff mechanism, it gets more opportunities by almost 93% while others are kept at lower levels. Also, as q1 is large, it is likely possible for LBE to choose large N. Hence, while FBE and Wi-Fi are decrementing their random counters, FBE takes advantages. However, it is shown that for shorter q1, FI increases.

Table A.6.1 Numerical results of hhybrid Scenario with variable Wi-Fi transmission time.

TxWiFi	400	600	800	1000	1200	1400	1600	1800	2000	2200	2400
LBE	0	2	2	0	1	0	1	0	0	1	0
FBE	9	8	8	10	9	10	6	8	9	9	10
Wi-Fi	1	0	0	0	0	0	3	2	1	0	0
FI index	0.407	0.49	0.49	0.333	0.407	0.333	0.725	0.49	0.407	0.407	0.333
Average /10 Competitions										0.4383	
Average /10 runs										0.5037	

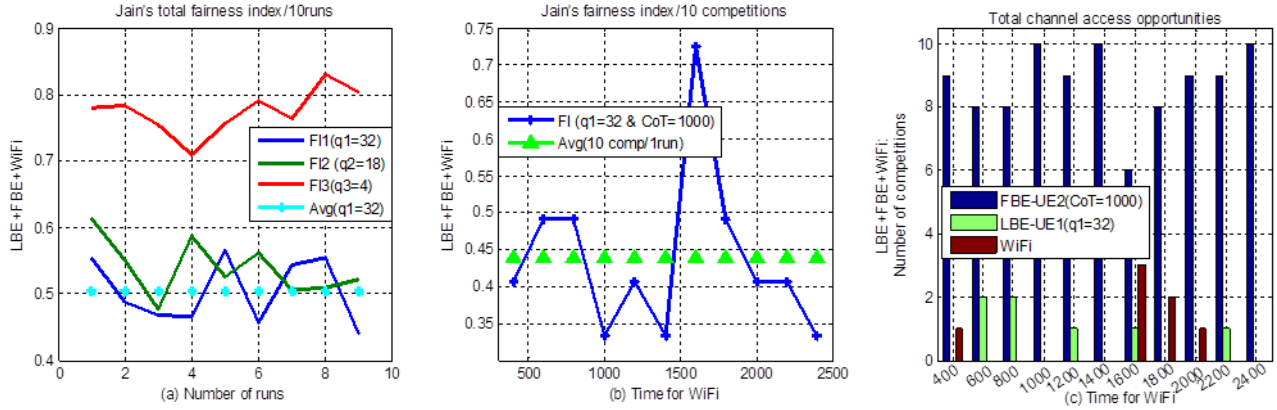

Figure A.6.1 Hybrid scenario with variable Wi-Fi transmission time ($q_1=32$ and $CoT_{FBE}=1000\mu s$).

A.7 LBE+FBE+Wi-Fi ($q=32$, $TxWiFi = 400 \mu s$ and $CoT \in [1 ms, 10 ms]$)

These are the results of hybrid scenario evaluated at $TxWiFi = 400 \mu s$, and by keeping the q_1 parameter fixed to the maximum value ($q_1=32$), with variable FBE's CoT. Similar to the above observation, FBE grabs most of the channel access opportunities while in most cases Wi-Fi and LBE are completely starved due to the same reasons explained above in Appendix A.6; which makes the average FI to remain at 47.55%. Here, it is also shown that for shorter q_1 close to 4, the FI increases.

Table A.7.1 Results of hybrid scheme with variable channel occupancy time.

CoT	1000	2000	3000	4000	5000	6000	7000	8000	9000	10000
LBE	0	1	0	0	0	0	0	0	0	1
FBE	7	8	8	8	10	8	8	6	10	9
Wi-Fi	3	1	2	2	0	2	2	4	0	0
FI index	0.575	0.505	0.49	0.49	0.333	0.49	0.49	0.641	0.333	0.407
Average /10 Competitions										0.4755
Average /10 runs										0.5021

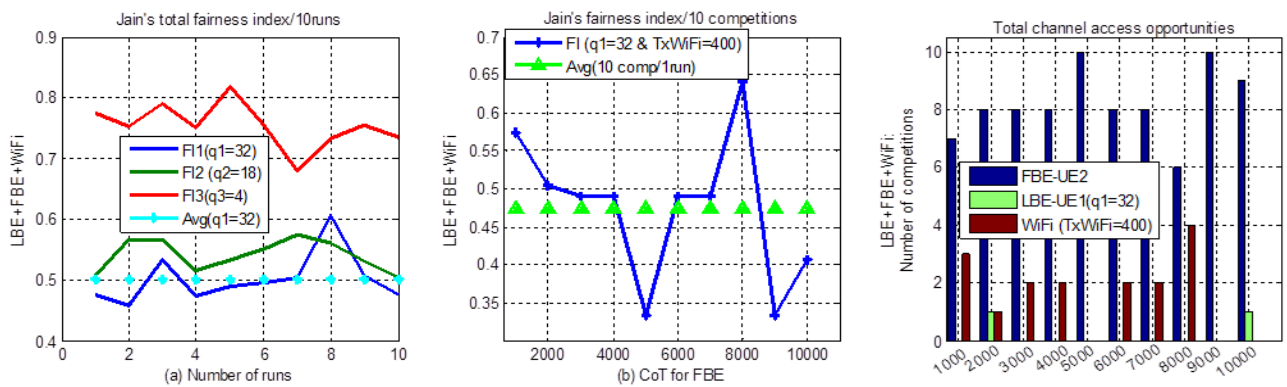

Figure A.7.1 Channel opporunities and FI with variable channel occupancy time.

Appendix B Additional Results based on the newly Proposed Mechanisms

For more clarifications, we also present additional results in addition to that shown in Chapter 5.

B.1 E-FBE1+E-FBE2 ($q_1=4$ & $q_2=32$, and $CoT \in [1\text{ ms}, 10\text{ ms}]$)

In the following, we show the results generated from a combination of two E-FBEs when there is a large difference between q_1 (for E-FBE1) and q_2 (for E-FBE2). Evaluation of access opportunities is done for $q_1=4$ and $q_2=32$, where results present large disparities between opportunities due to the imbalance between their respective CWs size. However, as q_1 tends to be equal to q_2 , FI increases up to 96.57%.

Table B.1.1 Opportunities & FI of two E-FBEs with variable channel occupancy time ($q_1=4$ & $q_2=32$).

CoT1	1000	2000	3000	4000	5000	6000	7000	8000	9000	10000
E-FBE1	7	8	8	9	9	10	9	8	9	10
E-FBE2	3	2	2	1	1	0	1	2	1	0
FI index	0.862	0.735	0.735	0.61	0.61	0.5	0.61	0.735	0.61	0.5
Average /10 Competitions									0.6507	
Average /10 runs									0.6875	

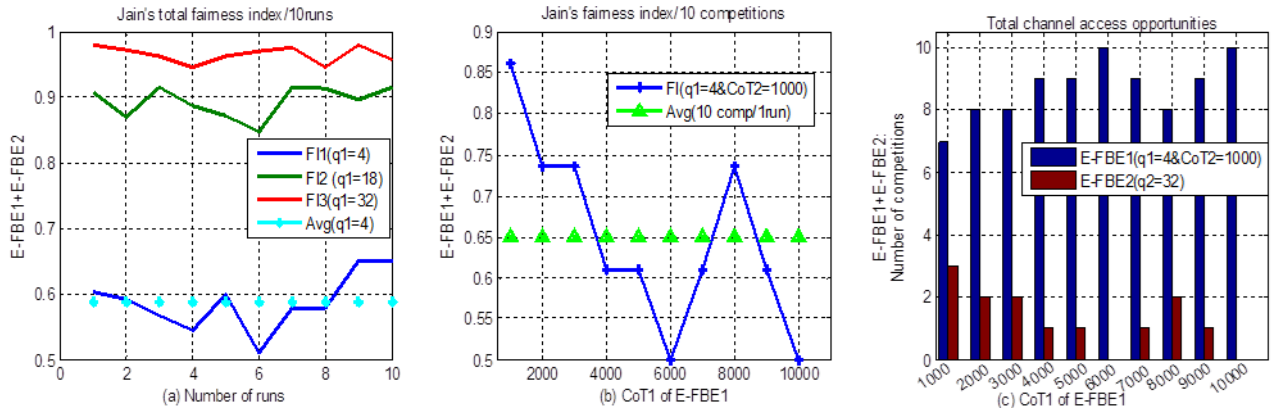

Figure B.1.1 Opportunities & FI of two E-FBEs with variable channel occupancy time ($q_1=4$ & $q_2=32$).

B.2 E-FBE+ original LBE ($q_2=4$ & $CoT_2=1000\ \mu\text{s}$, and $q_1 \in [4, 32]$)

Additional results for the combination of E-FBE and LBE are shown here below by considering q_2 value fixed at 4 and variable q_1 . In this case, E-FBE always gets more chances on the channel since it has shorter range of random counter N (1 to 4) while LBE scheme is starved at $q_1=32$. Generally, the FI increases as q_1 is approaching the fixed q_2 . However, it is shown that for the middle value q_2 ranger ($q_2=18$), the FI becomes much higher since the side q_1 values are approaching it.

Table B.2.1 Channel opportunities and FI between E-EBE and original LBE combination.

q1 of LBE	4	5	6	7	8	9	10	11	12	13	14	15	16	17	18
LBE	4	5	5	3	3	3	2	2	3	1	1	1	1	1	1
E-FBE	6	5	5	7	7	7	8	8	7	9	9	9	9	9	9
FI_index	0.962	1.000	1.000	0.862	0.862	0.862	0.735	0.735	0.862	0.610	0.610	0.610	0.610	0.610	0.610
q1 of LBE	19	20	21	22	23	24	25	26	27	28	29	30	31	32	
LBE	1	2	1	1	1	1	2	2	0	0	2	0	2	0	
E-FBE	9	8	9	9	9	9	8	8	10	10	8	10	8	10	
FI index	0.610	0.735	0.610	0.610	0.610	0.610	0.735	0.735	0.500	0.500	0.735	0.500	0.735	0.500	
Average /10 Competitions													0.6988		
Average /10 runs													0.7252		

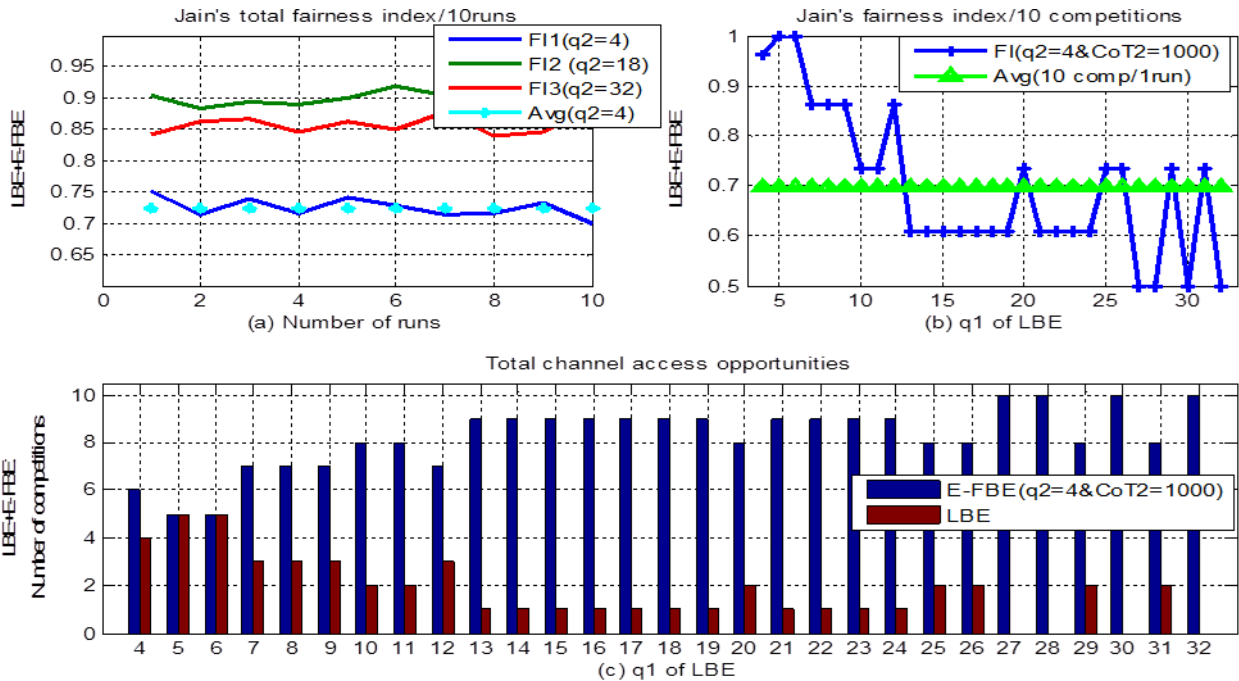

Figure B.2.1 Access opportunities and fairness between E-FBE and original LBE pair.

B.3 E-FBE+ original LBE ($q1=4$ & $q2=32$ and $CoT2 \in [1\ ms, 10\ ms]$)

In these results, we also show the performance of E-FBE and LBE when $q1$ (of LBE) is fixed to the minimum value ($q1 = 4$) and $q2$ values (of E-FBE) is set to the maximum value ($q2 = 32$) with variable E-FBE's CoT. Also, the severe imbalances between access opportunities are experienced because of different CW sizes. And as $q1$ tends to equal $q2$, FI increases. Similar to the observation in B.1, the FI significantly increases to 97.05% as $q1$ is approaching the middle $q2=18$ for both sides.

Table B.3.1 Fairness between E-FBE and LBE with variable channel occupancy time ($q2 = 32$).

CoT	1000	2000	3000	4000	5000	6000	7000	8000	9000	10000
LBE	9	10	9	9	10	9	10	8	10	9
E-FBE	1	0	1	1	0	1	0	2	0	1
FI index	0.61	0.5	0.61	0.61	0.5	0.61	0.5	0.735	0.5	0.61
Average /10 Competitions										0.5784
Average /10 runs										0.5878

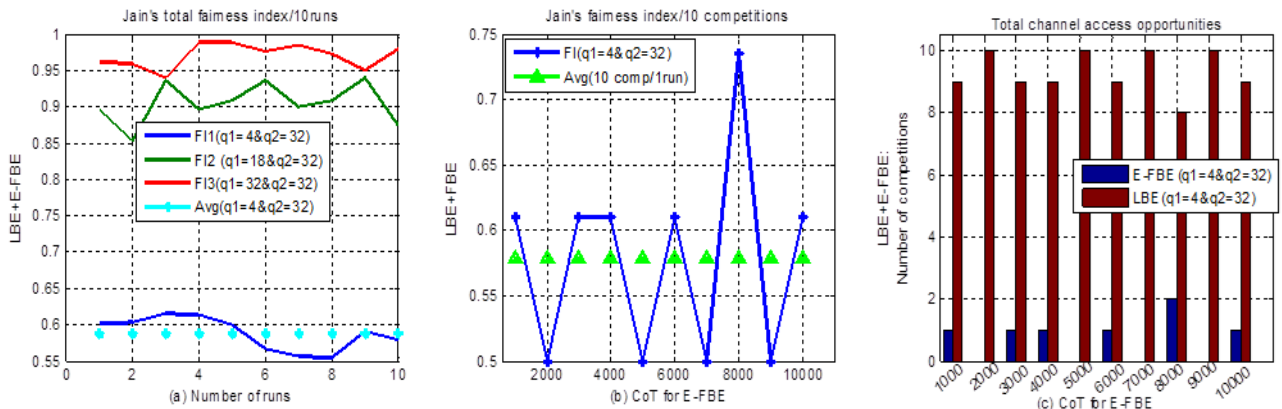

Figure B.3.1 Performance of E-FBE+LBE with variable channel occupancy time ($q2 = 32$).

B.4 E-FBE+Wi-Fi (q2=4 & TxWiFi = 400 μs and CoT ∈ [1 ms, 10 ms])

For the combination of E-FBE and Wi-Fi shown here, we evaluate its performance for q2 parameter fixed to 4, TxWiFi = 400 μs and with variable E-FBE's CoT. The results show that for a shorter q1, Wi-Fi gets least chances on the channel since E-FBE's CW is also short. Note here that CCA sensing time for E-FBE is 20 μs while DIFS = 34 μs for Wi-Fi. Meaning that, E-FBE can transmit while Wi-Fi is still scanning the channel. Mostly, Wi-Fi takes advantages in the 5% idle period of E-FBE. Hence if CoT is high, Wi-Fi can get chances. However, in general FI increases as q2 also gets larger.

Table B.4.1 Fairness indices for E-FBE and Wi-Fi pair with variable E-FBE's CoT.

CoT	1000	2000	3000	4000	5000	6000	7000	8000	9000	10000
E-FBE	10	10	10	10	9	8	9	9	9	7
Wi-Fi	0	0	0	0	1	2	1	1	1	3
FI index	0.5	0.5	0.5	0.5	0.61	0.735	0.61	0.61	0.61	0.862
Average /10 Competitions									0.6036	
Average /10 runs									0.6395	

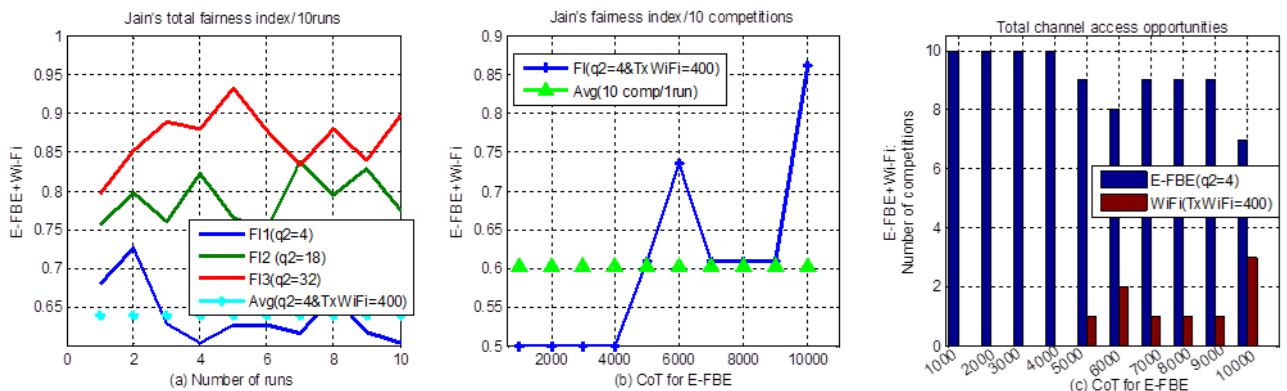

Figure B.4.1 Performance results of E-FBE and Wi-Fi with variable channel occupancy time.

B.5 E-FBE+Wi-Fi (q2=32 & CoT = 1000 μs and TxWiFi ∈ [400 μs, 2400 μs])

The performance of the combination of Wi-Fi and E-FBE is also shown when q2=32, CoT=1000 μs with variable TxWiFi. In this case, channel opportunities increases since the E-FBE's CW size is larger (N ∈ [1, 32]). Hence, both E-FBE and Wi-Fi users get chances, which also increase FI up to 88.19%. However, it has been shown that for lower values of q2 close to 4, Wi-Fi is starved as it is also illustrated hereafter in Table B.5.2 and Figure B.5.2

Table B.5.1 Jain's fairness index between E-FBE and Wi-Fi with variable TxWiFi (q2=32).

TxWiFi	400	600	800	1000	1200	1400	1600	1800	2000	2200	2400
E-FBE	3	6	9	4	7	7	6	6	2	4	6
Wi-Fi	7	4	1	6	3	3	4	4	8	6	4
FI index	0.862	0.962	0.61	0.962	0.862	0.862	0.962	0.962	0.735	0.962	0.962
Average /10 Competitions									0.8819		
Average /10 runs									0.8849		

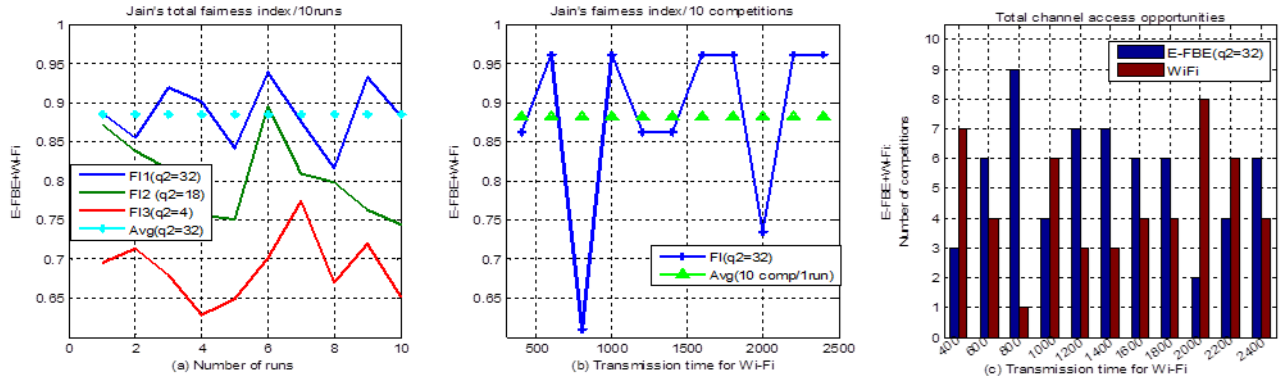

Figure B.5.1 Access opportunities between E-FBE and Wi-Fi with variable TxWiFi ($q_2=32$).

Table B.5.2 FI between E-FBE and Wi-Fi with variable TxWiFi ($q_2=4$).

TxWiFi	400	600	800	1000	1200	1400	1600	1800	2000	2200	2400
E-FBE	10	10	10	8	10	7	9	6	10	7	8
Wi-Fi	0	0	0	2	0	3	1	4	0	3	2
FI index	0.5	0.5	0.5	0.735	0.5	0.862	0.61	0.962	0.5	0.862	0.735
Average /10 Competitions										0.6605	
Average /10 runs										0.6952	

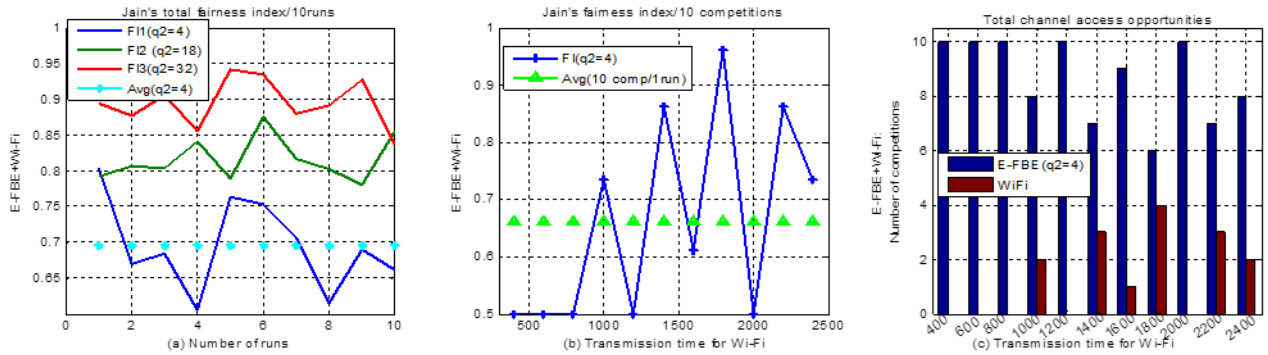

Figure B.5.2 Channel opportunities between E-FBE and Wi-Fi with variable TxWiFi ($q_2=4$).

B.6 E-FBE+Wi-Fi+LBE ($q_2=4$ & $T = 1000 \mu s$, TxWiFi = $400 \mu s$ and $q_1 \in [4 \text{ to } 32]$)

The performance of E-FBE in hybrid scenario is shown when q_2 parameter is fixed to 4 and for q_1 made variable. The results demonstrate that for q_1 values close to $q_2=4$, the FI increases while it becomes worse for large q_1 . Since E-FBE has shorter CW, it always wins as q_1 gets larger. However, the general observation indicates that as q_1 tends to be equal to q_2 , the FI increases.

Table B.6.1 Numerical results of E-FBE in hybrid scenario with variable backoff scaler q_1 .

q1 of LBE	4	5	6	7	8	9	10	11	12	13	14	15	16	17	18
LBE	5	4	4	3	3	4	2	1	2	1	1	1	2	1	1
E-FBE	4	5	5	4	6	6	7	6	7	7	6	8	8	7	9
Wi-Fi	1	1	1	3	1	0	1	3	1	2	3	1	0	2	0
FI_index	0.794	0.794	0.794	0.980	0.725	0.641	0.617	0.725	0.617	0.617	0.725	0.505	0.490	0.617	0.407
q1 of LBE	19	20	21	22	23	24	25	26	27	28	29	30	31	32	
LBE	2	1	1	1	0	1	2	1	0	0	0	0	1	1	
E-FBE	8	7	9	7	10	7	8	9	6	10	10	9	8	9	
Wi-Fi	0	2	0	2	0	2	0	0	4	0	0	1	1	0	
FI index	0.490	0.617	0.407	0.617	0.333	0.617	0.490	0.407	0.641	0.333	0.333	0.407	0.505	0.407	
Average /10 Competitions														0.5742	
Average /10 runs														0.6131	

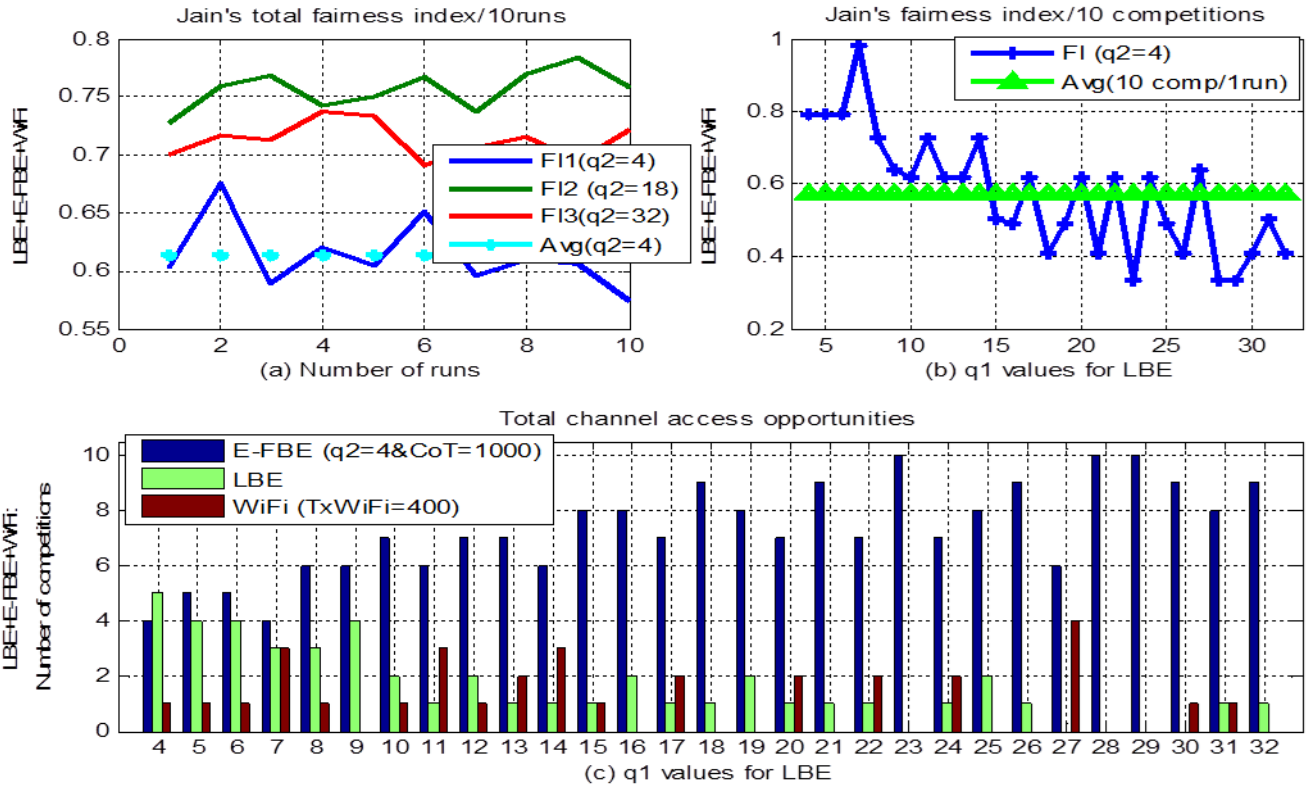

Figure B.6.1 Performance of E-FBE in hybrid scenario with variable backoff scaler q_1

B.7 E-FBE+Wi-Fi+LBE ($q_1=4$ & $= 32$, $TxWiFi = 400 \mu s$ and $CoT \in [1 ms \text{ to } 10 ms]$)

The other additional results of hybrid scenario are shown for q_1 (of LBE) set to 4, q_2 (E-FBE) fixed to 32 and $TxWiFi = 400 \mu s$ with E-FBE's CoT variable. However, LBE gets more opportunities on the shared channel, since it has the shortest CW compared to others. This degrades FI to 45.96%.

Table B.7.1 Numerical results of hybrid scenario with variable E-FBE's CoT.

CoT	1000	2000	3000	4000	5000	6000	7000	8000	9000	10000
LBE	8	8	9	9	10	9	7	9	7	9
E-FBE	1	0	0	1	0	1	1	0	1	1
Wi-Fi	1	2	1	0	0	0	2	1	2	0
FI index	0.505	0.49	0.407	0.407	0.333	0.407	0.617	0.407	0.617	0.407
Average /10 Competitions										0.4596
Average /10 runs										0.4649

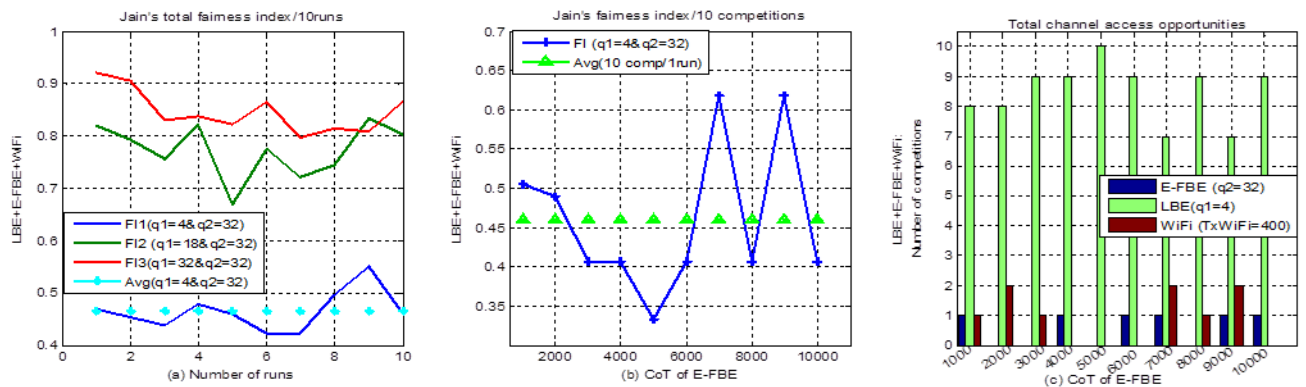

Figure B.7.1 E-FBE in hybrid scenario with variable E-FBE's CoT.

B.8 E-FBE+Wi-Fi+LBE (E-FBE's CoT = 1000 μ s and TxWiFi \in [400 μ s to 2400 μ s])

Similarly, we also show additional results of E-FBE in hybrid scenario when TxWiFi is variable. By consider $q_1=32$ for LBE, and $q_2=32$ and $CoT=1000 \mu s$ for E-FBE., the results indicate access opportunities are almost the same for all three schemes. But this is happen when parameters q_1 and q_2 have comparatively equal values since their respective CWs will also be the same. However, if there is a big difference between q_1 and q_2 (say $q_1=4$ and $q_2=32$), only LBE gets more chances and the FI is greatly reduced as it the case for the illustration of Table B.8.2 and Figure B.8.2.

Table B.8.1 Numerical results for E-FBE in hybrid scenario for a variable TxWiFi ($q_1=32$ & $q_2=32$).

TxWiFi	400	600	800	1000	1200	1400	1600	1800	2000	2200	2400
LBE	2	4	4	5	4	6	4	5	5	2	5
E-FBE	3	3	4	3	4	3	6	5	3	2	3
Wi-Fi	5	3	2	2	2	1	0	0	2	6	2
FI index	0.877	0.98	0.926	0.877	0.926	0.725	0.641	0.667	0.877	0.758	0.877
Average /10 Competitions										0.8301	
Average /10 runs										0.846	

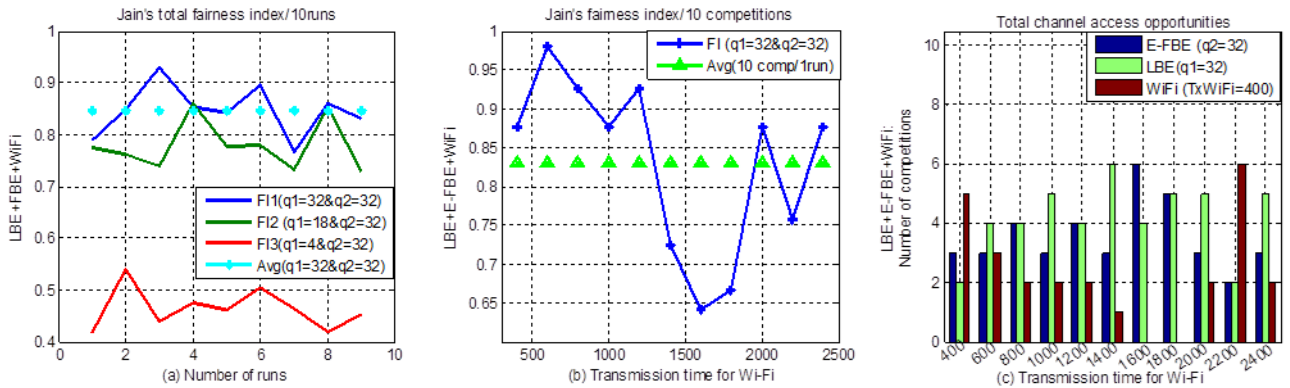

Figure B.8.1 Performance of E-FBE in hybrid scenario for a variable TxWiFi ($q_1 = 32$ & $q_2 = 32$).

Table B.8.2 Numerical results for E-FBE in hybrid scenario for a variable TxWiFi ($q_1 = 4$ & $q_2 = 32$).

TxWiFi	400	600	800	1000	1200	1400	1600	1800	2000	2200	2400
LBE	9	10	9	8	9	8	8	8	8	9	7
E-FBE	0	0	1	1	1	0	0	1	2	1	1
Wi-Fi	1	0	0	1	0	2	2	1	0	0	2
FI index	0.407	0.333	0.407	0.505	0.407	0.49	0.49	0.505	0.49	0.407	0.617
Average /10 Competitions										0.4598	
Average /10 runs										0.4641	

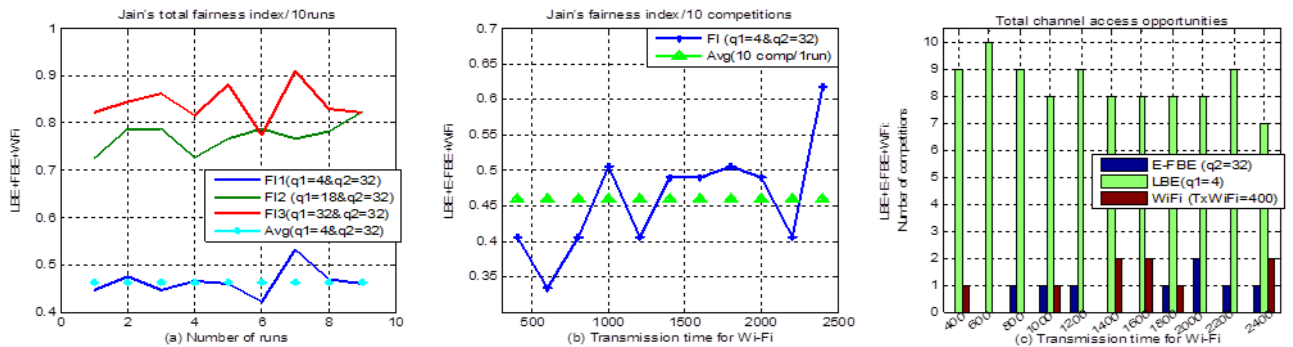

Figure B.8.2 Performance of E-FBE in hybrid scenario for a variable TxWiFi ($q_1 = 4$ & $q_2 = 32$).

Appendix C Implemented Matlab codes for E-FBE in Hybrid Scenario

Statement:

All the algorithms shown above in the main text have been implemented using Matlab simulation. If these codes are printed out, the length will be 88 pages. Therefore, for illustration purpose, we only list codes of E-FBE-based mechanism in hybrid scenario here in Appendix C.

```

clear all
close all
clc
out=1;
while out<=10
    a=1;
    j=4; %q1 parameter for LBE
    K=10; % Number of trials
    N=3; %number of Users (hybrid)
    %if there is fairness, every LBE, FBE and WiFi get K/N chances(Fair=optimum value)
    Fair=K/N;
    while j<=32
        %%initialization of CCA
        CCA1=0; CCA2=0; CCA3=0;

        q1=j; %q1 for LBE
        q3=32; %% for FBE
        TxSTA1=400; %%WiFi transmission time
        CoT3=1000; % FBE UE transmission time
        % % % Initialization of uniform random counters
        N1=0; N2=0; N3=0;
        DIFS=34;
        % % %initialization of UE1 access counts
        Ue1_count=0; STA1_count=0; Ue3_count=0;
        i=0; % initialization of number of competitions
        Tr=0;
        %%%initialization of total time including CCA and transmission times
        TCoT1=0; TCoT2=0;TCoT3=0; TCCA1=0; TCCA2=0;TCCA3=0;
        IdleT3=(0.05*CoT3)-20;%% calculation of 5% silent period for FBE
        %%% Main program
        while i<10
            if N1==0
                N1=randi([1,q1]); %% random backoff counter for LBE
            else
                N1=N1;
            end
            if N2==0
                r1=randi([0,4]);
                N2=(2^r1)-1; %% random backoff counter for WiFi
                TCCA2=TCCA2+DIFS;%% initial CCA2(DIFS is used)%
            else
                N2=N2;
            end
            if N3==0
                N3=randi([1,q3]); %% random backoff counter for FBE
            else
                N3=N3;
            end
        end
    end
end

```

```

while N1>0 && N2>0 && N3>0
  % % % =====initial elapsed time for LBE
  CCA1=CCA1+20; %% initial CCA1 of LBE
  TCCA1=TCCA1+CCA1;
  % % % =====initial elapsed time for FBE
  CCA3=CCA3+20; %% initial CCA3 of FBE
  TCCA3=TCCA3+CCA3;
  %====LBE scheme tests if the channel is free
  if ((TCCA1>=TCoT2 && TCCA1>=(TCoT3-IdleT3))||(TCCA1>=TCoT2 && TCCA1>=(TCoT3-CoT3-
IdleT3)))
    N1=N1-1;
    if N1==0
      TCoT1=TCCA1;
      CoT1=(13*q1/32)*1000; %Transmission if counter is zero
      TCoT1=TCoT1+CoT1; %% update the CoT
      Ue1_count=Ue1_count+1; %% count the chances
      TCCA1=TCoT1;
  % % % =reset transmission to the same values to initiate the next competition
      TCCA2=TCoT1;
      TCCA3=TCoT1;
    end
    elseif (CCA1>0 && TCCA1<TCoT2 || TCCA1<TCoT3)
      N1=N1; %freeze%%if the channel is found busy
    end
    %%%====WiFi scheme tests if the channel is free
    if ((TCCA2>=TCoT1 && TCCA2>=(TCoT3-IdleT3))||(TCCA2>=TCoT1 && TCCA2>=(TCoT3-CoT3-
IdleT3)))
      TCCA2=CCA2+9; %% check channel for DIFS, and for one time slot (9 usec)
      N2=N2-1;
      if N2==0
        Tr=1;
        TCoT2=TCCA2;
        TCoT2=TCoT2+TxSTA1; %transmission
        STA1_count=STA1_count+1;
        TCCA2=TCoT2;
  % % % =reset transmission to the same values to initiate the next competition
        TCCA1=TCoT2;
        TCCA3=TCoT2;
      end
      elseif (CCA2>0 && TCCA2<TCoT1 || TCCA2<TCoT3)
        N2=N2; %freeze if the channel is found busy
        %=====
      end
      %%%====FBE scheme tests if the channel is free
      if (CCA3>0 && TCCA3>=TCoT2 && TCCA3>=TCoT1)
        %transmission
        N3=N3-1;
        if N3==0
          TCoT3=TCCA3;
          TCoT3=TCoT3+CoT3;
          TCCA3=TCoT3;
          TCCA3=TCCA3+IdleT3;
          Ue3_count=Ue3_count+1;
  % % % ====reset transmission to the same values to initiate the next competition
          TCCA1=TCoT3;
          TCCA2=TCoT3;
        end
        elseif (CCA3>0 && TCCA3<TCoT2 || TCCA3<TCoT1)
          N3=N3; %%if channel busy freeze
        end
      end
    end
  end
end

```

```

end
i=i+1;
end
% % % % Number of access opportunities
LBE_UE1=Ue1_count; STA1=STA1_count;FBE_UE3=Ue3_count;

% % % ===avoiding counts exceeding 10 competitions
if ((STA1+LBE_UE1+FBE_UE3)>10 ||(STA1+LBE_UE1+FBE_UE3)<10)
    Tr=0;
else
    LBE(a)=LBE_UE1;
    FBE(a)=FBE_UE3;
    STA(a)=STA1;
    q(a)=j;
% % % %====CALCULATE FAIRNESS INDEX
    Ti_LBE(a)=LBE(a); %Measured access opportunities(Ti) for UE1
    Ti_FBE(a)=FBE(a); %Measured access opportunities(Ti) for UE2
    Ti_STA(a)=STA(a); %Measured access opportunities(Ti) for WiFi

% % % %5====Normalized opportunities(Xi)
    Xi_LBE(a)=Ti_LBE(a)/Fair;
    Xi_FBE(a)=Ti_FBE(a)/Fair;
    Xi_STA(a)=Ti_STA(a)/Fair;

    Num=Xi_LBE(a)+Xi_FBE(a)+Xi_STA(a);
    Numerator_SUM_LBE_FBE_STA(a)=Num^2;

    ss1=Xi_LBE(a); ss2=Xi_FBE(a); ss3=Xi_STA(a);
% % % %===calculate the square of every element for both LBE_FBE and STA
    Square_Xi_LBE(a)=ss1^2;
    Square_Xi_FBE(a)=ss2^2;
    Square_Xi_STA(a)=ss3^2;
    Deno_Sum_Square_Xi_LBE_FBE_STA(a)=Square_Xi_LBE(a)+Square_Xi_FBE(a)+Square_Xi_STA(a);
% ====Avoiding divide by zero in Pre-Indices
    if Deno_Sum_Square_Xi_LBE_FBE_STA(a)>0
        FI_LBE_FBE_STA(a)=Numerator_SUM_LBE_FBE_STA(a)/(N*Deno_Sum_Square_Xi_LBE_FBE_STA(a));
% JFI for LBE UE1
    else
        FI_LBE_FBE_STA(a)=0;
    end
    j=j+1;
    a=a+1;
end
end
% % % %===display hybrid scenario (LBE+FBE+WiFi)
Xi_LBE; Xi_FBE; Xi_STA;

Numerator_SUM_LBE_FBE_STA;
Deno_Sum_Square_Xi_LBE_FBE_STA;

FI_LBE_FBE_STA;
% % % %====%get Final average fairness
SUM_FI=sumabs(FI_LBE_FBE_STA);
Tot_Fairness_Inner=SUM_FI/(a-1);% % Fairness for the inner loop(one run)

% % % %====plotting outer loop(10 runss)
Tot_FI_out(out)=Tot_Fairness_Inner;
k(out)=out;

```

```

out=out+1;
Average_Tot_FI_out=sumabs(Tot_FI_out)/(out-1);
end

% % % %====plotting 3 Figures into one
figure;
subplot(2,2,1)
p=plot(k,Tot_FI_out,'-',k,Average_Tot_FI_out,'m-o'); % fairness for outer loop
set(p, 'LineWidth',2.5)
ylabel('LBE+FBE+WiFi')
title('Jain`s total fairness index/10runs')
xlabel('(a) Number of runs')
legend('Index', 'Average (10 runs)')%
grid on
subplot(2,2,2)
p= plot(q,FI_LBE_FBE_STA, '-+', q,Tot_Fairness_Inner, 'g-^');
set(p, 'LineWidth',2.5)
xlim([3 33])
title({'Jain`s fairness index/10 competitions'})
ylabel('LBE+FBE+WiFi')
xlabel(' (b) q1 values for LBE-UE1')
legend('FI (CoT2=1000 & TxWiFi=400)', 'Average (10 comp.)')
grid on
subplot(2,2,[3,4])
bar(q, [FBE' LBE' STA'], 1)
set(gca, 'XTick', q)
xlim([3 33])
ylim([0 10.5])
title('Total channel access opportunities')
xlabel('(c) q1 values for LBE-UE1')
ylabel({'LBE+FBE+WiFi';'Number of competitions'}) %%%display two lines on the label
grid on
legend('FBE-UE2 (CoT2=1000)', 'LBE-UE1', 'WiFi (TxWiFi=400)')
% % % %=====END of a plot of three figures into one

```