

**Cooperative Communications
in Wireless Local Area Networks:
MAC Protocol Design and
Multi-layer Solutions**

Xin He

**Cooperative Communications in Wireless Local
Area Networks: MAC Protocol Design and
Multi-layer Solutions**

A Dissertation Submitted in Partial Fulfillment of the Requirements for the
Degree of *Philosophiae Doctor (PhD)* in Mobile Communication Systems:
Network, Security and Formal Methods

Department of Information and Communication Technology

University of Agder

2012

Doctoral Dissertations at the University of Agder

ISBN: 978-82-7117-711-9

ISSN: 1504-9272

Series No.: 48

Copyright ©Xin He, 2012

All rights reserved unless otherwise stated.

Printed by the Printing Office, University of Agder

Kristiansand

“If you are brave enough to leave behind everything familiar and comforting (which can be anything from your house to your bitter old resentments) and set out on a truth-seeking journey (either externally or internally), and if you are truly willing to regard everything that happens to you on that journey as a clue, and if you accept everyone you meet along the way as a teacher, and if you are prepared - most of all - to face (and forgive) some very difficult realities about yourself then truth will not be withheld from you.”

Elizabeth Gilbert, *Eat, Pray, Love* (2006)

Dedicated to my mother

Preface and Acknowledgements

The research work covered in this PhD dissertation was performed from March 2008 to November 2011 within the framework of the NFR Secure and Reliable Wireless and Ad hoc Communications (SWACOM) project, at the Agder Mobility Laboratory, Department of Information and Communication Technology (ICT), University of Agder (UiA), Norway. The work during the period from April 2011 to July 2011 was performed at Georgia Institute of Technology (GATECH), Atlanta, Georgia, USA, supported by the EU FP7 Security, Services, Networking and Performance of Next Generation IP-based Multimedia Wireless Networks (S2EuNet) project.

Many individuals provided their technical and spiritual support in this PhD work. I, therefore, would like to take this opportunity to express my gratitude to them. First, I would like to thank my supervisor, Prof. Frank Y. Li, for his guidance and patience throughout my PhD study. Besides academic support, he contributed very much on my way to develop a structured work attitude and better presentation skills. I am thankful to Prof. John R. Barry and Prof. Raghupathy Sivakumar for inviting me to visit their lab at GATECH and making my research there an interesting and valuable experience.

My sincere gratitude goes to the PhD fellows (present and former) at the Departments of ICT and Mechatronics at UiA, especially to Terje Gjørseter, Lei Jiao, Liping Mu, Ziaul Haq Abbas, Ram Kumar, Yuanyuan Ma and Nils Randulf Kristiansen. With their company, my PhD journey became much more pleasant and satisfying. Special acknowledgment goes to my friends, Dr. Mattias Lampe and Prof. Hans Grelland, for their kind support and encouragement. I also extend my gratitude to the former coordinator of the PhD Program at the Department of ICT, Trine Tønnessen.

Last, but not least, I would like to thank my husband Jostein for his love and devotion. Without his support, I would hardly have come to the final stage of this adventure.

Xin He
February 2012
Grimstad, Norway

ABSTRACT

This dissertation addresses cooperative communications and proposes multi-layer solutions for wireless local area networks, focusing on cooperative MAC design. The cooperative MAC design starts from CSMA/CA based wireless networks. Three key issues of cooperation from the MAC layer are dealt with: i.e., when to cooperate (opportunistic cooperation), whom to cooperate with (relay selection), and how to protect cooperative transmissions (message procedure design). In addition, a cooperative MAC protocol that addresses these three issues is proposed. The relay selection scheme is further optimized in a clustered network to solve the problem of high collision probability in a dense network. The performance of the proposed schemes is evaluated in terms of throughput, packet delivery rate and energy efficiency. Furthermore, the proposed protocol is verified through formal model checking using SPIN. Moreover, a cooperative code allocation scheme is proposed targeting at a clustered network where multiple relay nodes can transmit simultaneously. The cooperative communication design is then extended to the routing layer through cross layer routing metrics. Another part of the work aims at enabling concurrent transmissions using cooperative carrier sensing to improve the performance in a WLAN network with multiple access points sharing the same channel.

LIST OF PUBLICATIONS

The author of this dissertation is the principal contributor and the first author of all the papers listed below. Papers A-G in the first set are selected to represent the main research achievements and are reproduced as Part II of this dissertation. The seven papers listed in the second set are complementary to the main focus. They are not included in this dissertation in order to highlight the main contributions of this PhD work.

Set I: Papers Included in the Dissertation

- Paper A** X. He, and F. Y. Li, "Cooperative MAC Design in Multi-hop Wireless Networks - Part I: When Source and Destination are within the Transmission Range of Each Other", *Wireless Personal Communications, Springer*, Vol. 57, No. 3, pp. 339-350, DOI: 10.1007/s11277-010-0072-y, 2011.
- Paper B** X. He, and F. Y. Li, "Optimization of the Relay Selection Scheme in Cooperative Retransmission Networks", *Proc. of IEEE 73rd Vehicular Technology Conference (VTC)*, Budapest, Hungary, May 2011.
- Paper C** X. He, R. Kumar, L. Mu, T. Gjørseter and F. Y. Li, "Formal Verification of a Cooperative Automatic Repeat reQuest MAC Protocol", *Computer Standards & Interfaces, Elsevier*, DOI:10.1016/j.csi.2011.12.001, online Dec. 2011.
- Paper D** X. He, and F. Y. Li, "Throughput and Energy Efficiency Comparison of One-hop, Two-hop, Virtual Relay and Cooperative Retransmission Schemes", *Proc. of European Wireless*, Lucca, Italy, April 2010.

Paper E X. He, and F. Y. Li, "Metric-based Cooperative Routing in Multi-hop Ad Hoc Networks", *Journal of Computer Networks and Communications, Hindawi*, accepted in Jan. 2012.

Paper F X. He, and F. Y. Li, "Cooperative Communication Design with Distributed Code Allocation in a Clustered Network", *Proc. of IEEE International Symposium on Personal, Indoor and Mobile Radio Communications (PIMRC)*, Toronto, Canada, Sept. 2011.

Paper G X. He, S. Lakshmanan, R. Sivakumar and F. Y. Li, "Enabling Concurrency in Wi-Fi Networks using Positional Carrier Sense", submitted to *IEEE Wireless Communications and Networking Conference (WCNC)*, 2013.

Set II: Papers Not Included in the Dissertation

1. X. He, F. Y. Li, and J. Lin, "Link Adaptation Combined with Optimal Frame Size and Rate Selection in Error-prone 802.11n Networks", *Proc. of IEEE International Symposium on Wireless Communication Systems (ISWCS)*, Reykjavik, Iceland, Oct. 2008.
2. X. He, and F. Y. Li, "An Automatic Retransmission Cooperative MAC Protocol in Wireless Local Area Networks", *Proc. of European Wireless*, Aalborg, Denmark, May 2009.
3. X. He, and F. Y. Li, "Cooperative RTS/CTS MAC Protocol with Relay Selection in Distributed Wireless Networks", *Proc. of International Conference on Ultra Modern Telecommunications (ICUMT)*, St. Petersburg, Russia, Oct. 2009.
4. X. He, and F. Y. Li, "A Multi-relay Cooperative Automatic Repeat Request Protocol in Wireless Networks", *Proc. of IEEE International Conference on Communications (ICC)*, Cape Town, South Africa, May 2010.
5. X. He, and F. Y. Li, "Energy Consumption and Optimal Relay Node Placement for Cooperative Retransmissions", *Proc. of IEEE International Symposium on Wireless Communication Systems (ISWCS)*, York, UK, Sept. 2010.
6. X. He, R. Kumar, L. Mu and T. Gjørseter, "Formal Verification of a Cooperative Automatic Repeat Request MAC Protocol", *Proc. of Norwegian Informatics Conference (NIK)*, Gjøvik, Norway, Nov. 2010.
7. X. He, and F. Y. Li, "An Optimal Energy Efficient Cooperative Retransmission MAC Scheme in Wireless Networks", *Proc. of Wireless Communication, Vehicular Technology, Information Theory and Aerospace & Electronic Systems Technology (Wireless VITAE)*, Chennai, India, Feb. 2011.

CONTENTS

| | |
|--|--------------|
| Preface | ix |
| Abstract | xi |
| List of Publications | xi |
| List of Figures | xxi |
| List of Tables | xxv |
| Abbreviations | xxvii |
| | |
| PART I | 1 |
| | |
| 1 Introduction | 1 |
| 1.1 Wireless Communication | 1 |
| 1.2 Cooperative Systems | 2 |
| 1.3 Advantages and Disadvantages of Cooperative Communications | 4 |
| 1.4 Classification of Cooperative Systems | 6 |
| 1.5 Research Objectives | 7 |
| 1.6 Performance Parameters and Evaluation Methodology | 10 |
| 1.6.1 Performance Parameters | 10 |
| 1.6.2 Methodology and Tools | 12 |
| 1.7 Organization of the Dissertation | 12 |
| | |
| 2 Cooperative MAC Protocol Design | 15 |
| 2.1 Cooperative MAC Design | 16 |
| 2.1.1 Cooperative retransmission | 16 |

| | | |
|----------|--|---------------|
| 2.1.2 | Multi-rate cooperative MAC | 17 |
| 2.1.3 | Space-time relaying | 17 |
| 2.2 | Cooperative Retransmission in WLANs | 17 |
| 2.3 | Cooperative Retransmission MAC Protocol: C-ARQ | 18 |
| 2.4 | Relay Scheme Optimization in Single-Relay C-ARQ | 19 |
| 2.5 | Formal Verification of Cooperative Retransmission Protocols | 21 |
| 2.5.1 | Model checking with SDL, SPIN and PROMELA | 21 |
| 2.5.2 | Formal verification of C-ARQ | 22 |
| 3 | Cooperative Networking in Multi-hop Ad Hoc Networks | 25 |
| 3.1 | Multi-hop Networks and Cross-layer Cooperation | 25 |
| 3.2 | Comparison of Cooperative MAC Schemes | 26 |
| 3.3 | Cooperative Routing | 28 |
| 3.4 | Cross Layer Routing Metric | 28 |
| 4 | Cooperation with Multiple Simultaneous Relays | 31 |
| 4.1 | Space-Time Relaying | 31 |
| 4.2 | Simultaneous Multi-relay Cooperative Scheme | 32 |
| 4.3 | Relay Selection and Code Allocation | 33 |
| 5 | Enabling Co-channel Concurrent Transmissions in WLANs | 35 |
| 5.1 | Introduction of WLAN | 35 |
| 5.2 | Problems with CSMA/CA | 36 |
| 5.3 | Transmission Concurrency | 38 |
| 5.4 | Concurrent Transmission Principle | 39 |
| 5.5 | C^2SMA/CA : Multi-link Concurrency Scheme | 40 |
| 6 | Conclusions and Future Work | 43 |
| 6.1 | Contributions | 43 |
| 6.2 | Limitations of the Research | 44 |
| 6.3 | Suggestions for Future Research | 45 |
| | References | 47 |
| | PART II | 57 |
| A | Cooperative MAC Design in Multi-hop Wireless Networks Part I: When Source and Destination are within the Transmission Range of Each Other | 59 |
| B | Optimization of the Relay Selection Scheme in Cooperative Retransmission Networks | 79 |

| | | |
|----------|--|------------|
| C | Formal Verification of a Cooperative Automatic Repeat reQuest MAC Protocol | 97 |
| D | Throughput and Energy Efficiency Comparison of One-hop, Two-hop, Virtual Relay and Cooperative Retransmission Schemes | 125 |
| E | Metric-based Cooperative Routing in Multi-hop Ad Hoc Networks | 149 |
| F | Cooperative Communication Design with Distributed Code Allocation in a Clustered Network | 179 |
| G | Enabling Co-Channel Concurrency in WLANs using Positional Carrier Sense | 197 |

LIST OF FIGURES

| | | |
|-----|--|-----|
| 1.1 | Application of Cooperative Communications in WLANs. | 3 |
| 1.2 | Cooperative Relaying in Cellular Networks. | 3 |
| 1.3 | Classification of Cooperative Systems. | 6 |
| 1.4 | Dissertation Outline. | 14 |
| 2.1 | Channel Model with Markov Chain. | 18 |
| 5.1 | Hidden Terminals. | 37 |
| 5.2 | Exposed Terminals. | 37 |
| 5.3 | IEEE 802.11 DCF RTS/CTS Scheme. | 38 |
| 5.4 | Concurrency Scheduling of the Secondary Transmission in Case 1110: ACK2 Finishes Transmission before ACK1 or Starts after ACK1. | 40 |
| A.1 | System Model for Cooperative Transmission. | 64 |
| A.2 | C-ARQ Basic Access Scheme. | 66 |
| A.3 | Performance Comparison in Sparse Networks. | 72 |
| A.4 | Performance of P.C-ARQ in Dense Networks as a Function of E_t/N_0 and p | 74 |
| A.5 | Performance of IT.C-ARQ in Dense Networks as a Function of E_t/N_0 and SNR Threshold. | 75 |
| A.6 | Performance Comparison in Dense Networks. | 77 |
| B.1 | System Model for Cooperative Transmission. | 83 |
| B.2 | C-ARQ Basic Scheme: Successful Cooperative Retransmission | 84 |
| B.3 | Simulations vs Analysis ($\theta_1=2.0$ dB, $\theta_2=5.0$ dB). | 93 |
| B.4 | PDR with Different Threshold Values ($E_b/N_0=0$). | 93 |
| B.5 | Throughput Performance Comparison ($SNR_{low}=2.0$ dB). | 94 |
| C.1 | System Model for Cooperative Transmission. | 102 |
| C.2 | C-ARQ Basic Access Scheme. | 104 |
| C.3 | Formal SDL Model for C-ARQ: Sender. | 109 |

| | | |
|------|--|-----|
| C.4 | Formal SDL Model for C-ARQ: Destination. | 110 |
| C.5 | Formal SDL Model for C-ARQ: Relay R. | 110 |
| C.6 | Formal SDL Model for C-ARQ: Relay H. | 111 |
| C.7 | Simulation Result for Case I: Direct Transmission Succeeds. | 114 |
| C.8 | Simulation Result for Case II: Direct Transmission Fails; First Cooperative Retransmission Succeeds. | 115 |
| C.9 | Simulation Result for Case III: Direct Transmission Fails; First Cooperative Retransmission Fails; Second Cooperative Retransmission Succeeds. | 116 |
| C.10 | Simulation Result for Case IVa: Cooperative Retransmission Fails: Packet Corruption on Both Qualified Relay Channels. | 117 |
| C.11 | Simulation Result for Case IVb: Cooperative Retransmission Fails: Packet Corruption on Single Qualified Relay Channel. | 118 |
| C.12 | Simulation Result for Case IVc: Cooperative Retransmission Fails: No Available Relay. | 119 |
| | | |
| D.1 | A Three-node Network with Cooperative Communications. | 129 |
| D.2 | Direct Transmission Scheme. The DATA and ACK Packets Are Transmitted at R_{sd} | 131 |
| D.3 | Virtual-hop Relay Scheme. DATA1 at R_{sr} ; DATA2 at R_{rd} ; and ACK at R_{sd} | 132 |
| D.4 | Cooperative Retransmission Scheme. DATA at R_{sd} ; DATA3 at R_{rd} ; ACK1 at R_{rd} ; and ACK2 at R_{sr} | 133 |
| D.5 | Relay Topologies for Performance Comparison. | 138 |
| D.6 | Throughput Performance with Relay in the Middle. | 140 |
| D.7 | Packet Delivery Rate with Relay in the Middle. | 140 |
| D.8 | Energy Consumption with Relay in the Middle. | 142 |
| D.9 | Energy Efficiency with Relay in the Middle. | 142 |
| D.10 | Throughput Performance with Relay Close to Source or Destination. | 143 |
| D.11 | Packet Delivery Rate with Relay Close to Source or Destination. | 144 |
| D.12 | Energy Consumption with Relay Close to Source or Destination. | 144 |
| D.13 | Throughput Performance with 50-byte Packets. | 145 |
| D.14 | Packet Delivery Rate with 50-byte Packets. | 146 |
| D.15 | Energy Consumption with 50-byte Packets. | 146 |
| D.16 | Energy Efficiency with 50-byte Packets. | 147 |
| | | |
| E.1 | CoopMAC: Virtual-hop Relay Scheme. | 157 |
| E.2 | C-ARQ: Cooperative Retransmission Scheme. | 158 |
| E.3 | Topology to Illustrate Cooperative Routing. | 158 |
| E.4 | Route for Highest Packet Delivery Ratio. | 170 |
| E.5 | Routing for Highest Throughput. | 170 |
| E.6 | Routing for Highest Energy Efficiency. | 171 |
| E.7 | Traditional Routing vs. Cooperative Routing: PDR. | 172 |
| E.8 | Traditional Routing vs. Cooperative Routing: Throughput. | 173 |

| | | |
|------|--|-----|
| E.9 | Traditional Routing vs. Cooperative Routing: Energy Efficiency. | 173 |
| E.10 | Parameters Tuning for PER Estimation. | 175 |
| F.1 | Clustered Network Model for Cooperative Communications. | 183 |
| F.2 | Cooperative Scheme with Space-Time Code Allocation. | 184 |
| F.3 | Packet Delivery Ratio Performance Comparison. | 192 |
| F.4 | Throughput Performance Comparison. | 193 |
| F.5 | Throughput with Different Relay Density. | 193 |
| F.6 | Energy Consumption Efficiency. | 194 |
| G.1 | System Model for Concurrent Transmissions. | 202 |
| G.2 | Possible Concurrency in the Double-Link Scenario. | 204 |
| G.3 | Concurrency Scheduling of the Secondary Transmission. | 206 |
| G.4 | Multi-link Concurrency Scheduling. | 207 |
| G.5 | Throughput CDF with Multiple Concurrent Links. | 211 |
| G.6 | Average Throughput Comparison with Multiple Concurrent Links. . . . | 212 |
| G.7 | Average Throughput Comparison with Different Network Densities. . . | 213 |
| G.8 | Average Throughput Comparison with Different Uplink/Downlink Traf- fic Ratio. | 214 |

LIST OF TABLES

| | | |
|-----|---|-----|
| 2.1 | Mapping Table from SNR to Backoff Time in Single-relay C-ARQ. | 20 |
| 5.1 | Concurrency Principle. | 39 |
| A.1 | Simulation Parameters. | 70 |
| A.2 | Optimal p in P.C-ARQ Scheme. | 73 |
| A.3 | Optimal SNR_{low} in IT.C-ARQ Scheme. | 74 |
| B.1 | Mapping from SNR to Backoff Time. | 85 |
| B.2 | Simulation Parameters (802.11g). | 92 |
| D.1 | Simulation Parameters. | 138 |
| D.2 | Modulation and Coding Scheme Set. | 138 |
| E.1 | Simulation Parameters. | 168 |
| E.2 | Modulation and Coding Scheme Set. | 169 |
| F.1 | Simulation Parameters. | 192 |
| G.1 | Concurrency Decision with PCS. | 205 |
| G.2 | Modulation and Coding Scheme Set. | 210 |

ABBREVIATIONS

| | |
|---------|--|
| A&F | Amplify-and-Forward |
| ACR | Automatic Cooperative Retransmission |
| ARQ | Automatic Repeat reQuest |
| BER | Bit Error Rate |
| BLAST | Bell Laboratories Layered Space-Time |
| BS | Base Station |
| C-ARQ | Cooperative Automatic Repeat reQuest |
| C&F | Compress-and-Forward |
| CDMA | Code Division Multiple Access |
| CFC | Call For Cooperation |
| CMAP | Conflict Maps |
| CoopMAC | Cooperative MAC |
| CSMA/CA | Carrier Sense Multiple Access with Collision Avoidance |
| CT | Concurrent Transmission |
| CTS | Clear-to-Send |
| CTSS | Clear To Send Simultaneously |

| | |
|----------|--|
| D&F | Decode-and-Forward |
| DCF | Distributed Coordination Function |
| DIFS | DCF InterFrame Space |
| DVCS | Virtual Carrier Sensing |
| EB.C-ARQ | Extended Back-off Cooperative Automatic Repeat ReQuest |
| EMR | Efficient Multi-rate Relaying |
| IT.C-ARQ | Increased Threshold Cooperative Automatic Repeat ReQuest |
| LTL | Linear Temporal Logic |
| MAC | Medium Access Control |
| MCS | Modulation and Coding Scheme |
| MGF | Moment Generating Function |
| MIMO | Multiple-Input-Multiple-Output |
| MS | Mobile Station |
| NAV | Network Allocation Vector |
| ODMA | Opportunity Driven Multiple Access |
| OLSR | Optimized Link State Routing |
| P.C-ARQ | P-persistent Cooperative Automatic Repeat ReQuest |
| PCS | Positional Carrier Sense |
| PDR | Packet Delivery Ratio |
| PER | Packet Error Rate |
| PRCSMA | Persistent Relay Carrier Sensing Multiple Access |
| PROMELA | Process or Protocol Meta Language |
| QoS | Quality of Service |
| RS | Relay Station |

| | |
|-------|---|
| RTS | Request-to-Send |
| RTSS | Request To Send Simultaneously |
| SDL | Specification and Description Language |
| SER | Symbol Error Rate |
| SIFS | Short InterFrame Space |
| SNR | Signal-to-Noise Ratio |
| SPIN | Sequential Programming in Process or Protocol Meta Language |
| SRDCF | Spatial Distributed Coordination Function |
| STBC | Space-Time Block Code |
| TC | Topology Control |
| UMTS | Universal Mobile Telecommunications System |
| WLAN | Wireless Local Area Network |
| WSN | Wireless Sensor Network |

PART I

INTRODUCTION

This chapter presents an overview of the dissertation. The first four sections give an outline on cooperative communications in wireless networks. The motivation for the research topic and the research objectives are presented in Section 1.5, and the research approaches are summarized in Section 1.6. The organization of the dissertation is given in the end.

1.1 Wireless Communication

Wireless communication is one of the fastest growing segments of the information and communication industry, providing information exchange between portable devices located anywhere in the world [1]. As an example of such growth, cellular phones have become essential equipment in business and indispensable tools in our daily life. As another form of wireless communication, Wireless Local Area Networks (WLANs), with hundreds of millions of stations in use today, provide Internet connection at homes, offices, campuses, cafes, train stations and airports [3]~[14]. At the same time, many other applications, such as Wireless Sensor Networks (WSNs), automated factories, smart homes and telemedicine, are emerging from research ideas to real-life deployments.

With the development of diverse kinds of applications of wireless communications, the demand for higher data rate is increasing, pushing the achieved data rates towards the saturation limit of channel capacity.

It has been observed that ‘*the wireless capacity has doubled every 30 months over the last 104 years*’ [15], which translates into an approximately million-fold capacity increase since the 1960s. These impressive gains are achieved by wider spectrum, division of the spectrum into smaller slices, higher order modulation schemes, and more efficient spatial reuse of the spectrum, e.g., through smaller cell sizes and shorter transmission distances in cellular networks.

However, these techniques are still not sufficient to meet the ever increasing demand. As a promising technique to further increase system capacity and transmission performance, *cooperative communication* has emerged recently, providing a new form of wireless communication paradigm.

1.2 Cooperative Systems

In traditional wireless communication systems, devices individually communicate with the associated receiver node and vice versa. However, the information transmitted from a source node can often be overheard not only by the receiver node, but also by their neighboring nodes. Traditionally, signals received by the neighboring nodes are treated as interference and many techniques have been developed to alleviate its effect. However, such ‘interference’ actually contains useful information for signal reception. Therefore, in cooperative communications, such information is forwarded to the destination by the surrounding node(s), known as relay(s), in order to improve the reception performance at the destination.

Generally speaking, a cooperative system is a communication system that utilizes relay nodes in the network to improve transmission performance. Due to various ways how relays can be deployed and utilized, a huge number of different types of cooperative systems exist. As an example, Fig. 1.1 illustrates a cooperative scenario in an infrastructure Wireless LAN, where the relay is used to improve the data transmission link from the source node to its associated Access Point (AP).

Another example of cooperative communication applications in cellular networks is illustrated in Fig. 1.2. Cellular networks generally suffer from three fundamental problems: interference, limited coverage and capacity shortage. To alleviate these problems, it is proposed that communication between a Base Station (BS) and a Mobile Station (MS) can be performed not only directly but also (or exclusively) via a Relay Station (RS). Such a deployment can yield significant gains, which can boost performance of

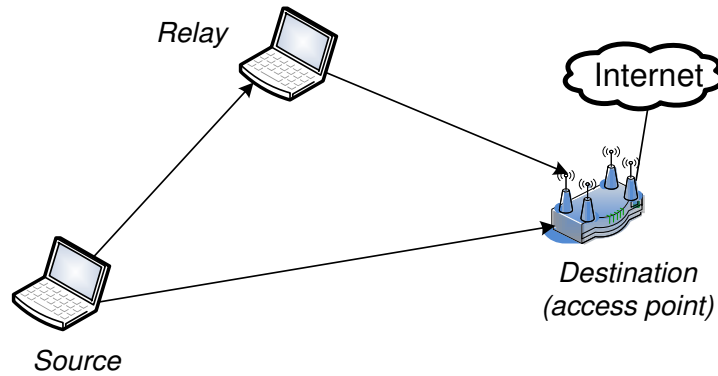

FIGURE 1.1: Application of Cooperative Communications in WLANs.

users that are capacity-limited (bottom-left cell in Fig. 1.2); coverage-limited (top-left cell) or interference-limited (middle-right cell) [16].

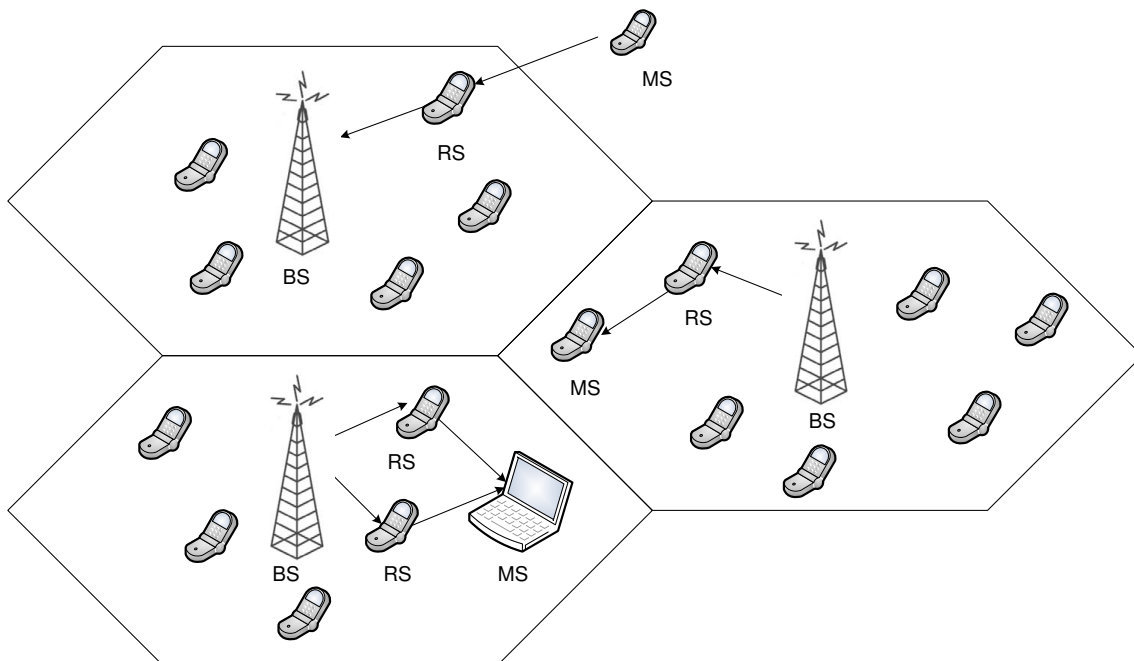

FIGURE 1.2: Cooperative Relaying in Cellular Networks.

Due to the above mentioned potential cooperative gains, an attempt has been made to push such relaying approaches into the Universal Mobile Telecommunications System (UMTS) standard [17]. The proposed access method was termed Opportunity Driven Multiple Access (ODMA) relaying protocol [18]~[20]. However, ODMA was dropped by 3GPP R99 as a result of concerns over complexity, battery life and signalling overhead [21]. On the other hand, IEEE 802.16j has developed a relay-enabled mode in

WiMAX in the hope of giving it a competitive edge over the 3GPP Long Term Evolution (LTE) development [22]. It is envisaged in [23] that LTE Advanced, the forthcoming 4G standard, will include cooperative relay features.

In summary, cooperative communications can find their niche in diverse applications, from increasing capacity or extending coverage in cellular networks to enhancing transmission reliability and network throughput in WLANs; from offering more stable links in volatile and dynamic propagation conditions in vehicular communications [24][25], to saving energy and extending network lifetime in WSNs.

1.3 Advantages and Disadvantages of Cooperative Communications

The key advantages of cooperative communications can be summarized as follows:

Cooperative Diversity Gain. Cooperative communications exploit space and time diversity in wireless networks in a distributed manner to improve system performance. The benefits of cooperative diversity can be translated into *reduced transmission power, higher throughput, better transmission reliability or larger network coverage*.

Balanced Quality of Service (QoS). In traditional systems, users at the edge of the network coverage or in shadowed areas with poor channel conditions may suffer from capacity limitations. However, cooperative relaying can be used to overcome this discrepancy and hence give more balanced QoS to all users.

Infrastructure-less Network Deployment. Cooperative communications ease the roll-out of a system that has no infrastructure available prior to deployment. For instance, in disaster-struck areas, relaying can be used to facilitate communications even though cellular systems or other existing communication systems are out of order.

Higher Energy Efficiency and Extended Network Lifetime. Cooperative transmission is also utilized to improve energy efficiency and extend the lifetime of networks composed of battery-operated nodes, e.g., sensors in a WSN. It has been shown that cooperative transmission schemes with multiple collaborative nodes can greatly improve network lifetimes by reducing the forwarding traffic loads of energy-depleting nodes [26] [27].

Reduced Costs. Cooperative communications provide more cost effective solutions in many cases. For example, in cellular networks, it has been shown that the cost of providing a given level of QoS to all users in the cell is generally lower with the help of cooperative communications [28].

On the other hand, there also exist a few major disadvantages in cooperative systems, as listed below.

Extra Relay Traffic and Interference. Extra resources in the form of frequency channels, time slots or orthogonal codes need to be allocated for relaying traffic. In addition, without smart power allocation schemes, cooperative relaying will certainly generate extra interference, which potentially causes deterioration of system performance.

Complex Schedulers. In cooperative systems, not only the traffic of different sources but also the relayed traffic needs to be scheduled. Therefore, more sophisticated scheduling is required. The complexity of scheduling mechanisms increases significantly when there are multiple users with multiple participating relays in the network.

Increased End-to-End Latency. Cooperative communications typically involve the reception and decoding of a data packet before it is re-transmitted by relays. With regard to delay-sensitive services, such as voice and increasingly popular multimedia services, the extra latency introduced by relaying may become detrimental.

Increased Overhead. The functioning of a cooperative system requires access control, synchronization, scheduling, additional security, etc. All these requirements certainly induce an increased overhead in comparison with traditional communication systems.

From what we observe above, the disadvantages of cooperative communications can be as significant as the advantages. Therefore, cooperative system design needs to be performed carefully in order to achieve the full gains of cooperative communications and at the same time to ensure that cooperation does not cause deterioration of system performance.

1.4 Classification of Cooperative Systems

From the perspective of implementation, cooperative systems can be classified according to different ways of utilizing relays. Here, we list a few factors that affect the realization of a particular cooperative system, as shown in Fig. 1.3.

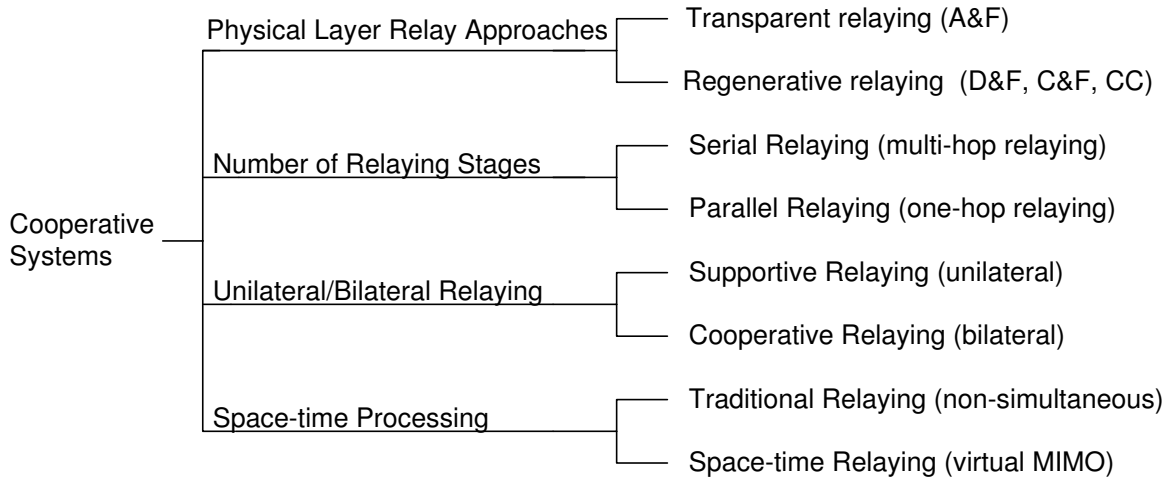

FIGURE 1.3: Classification of Cooperative Systems.

Firstly, one of the foremost design drivers in cooperative systems is the choice of relaying techniques at the physical layer. There are two main categories of relaying approaches, i.e., *transparent* and *regenerative* relaying. *Amplify-and-Forward (A&F)* is transparent (non-regenerative), which means that the relay does not decode data from the signal received from the direct link [29]. In contrast to *A&F*, the relay node in *Decode-and-Forward (D&F)* which belongs to regenerative relaying, decodes its received packet and then recodes the information and forwards it to the destination. There are also other regenerative relaying techniques such as *Compress-and-Forward (C&F)* [30] and *Coded Cooperation (CC)* [31]. The *C&F* approach initially suggested in [30], strikes a balance between the regenerative and non-regenerative methods. *CC* is a method that integrates cooperation into channel coding.

Secondly, the choice of the number of relaying stages is very important to system designers. As such, relays can operate either *in series* or *in parallel*. On the one hand, increasing the number of serial relaying nodes reduces the pathloss along each transmission hop. On the other hand, increasing the number of parallel relaying nodes increases potential diversity gains.

Thirdly, it can be generally distinguished if the cooperation is *unilateral* or *bilateral*. Typically, placing a relay node in between a source and destination node is referred to as supportive relaying or unilateral relaying. Supportive relaying can also be extended to cooperative relaying (bilateral), where at least two cooperative nodes are each other's respective relays at the same time to improve each other's communication reliability.

Another important factor is whether multiple relays are allowed to transmit simultaneously with space-time processing. In *traditional relaying*, multiple relays operate in serial or in parallel to deliver information from a source node towards its destination but cannot transmit simultaneously. While in *space-time processing relaying*, a distributed deployment of multiple nodes are employed to perform simultaneous space-time processing, forming a virtual Multiple-Input-Multiple-Output (MIMO) system.

Cooperative systems can differ from each other by choosing different factors mentioned above. There are many publications in the literature making efforts on designing various cooperative systems based on different application scenarios. However, the fundamental issues on cooperative communications apply to most cooperative systems.

1.5 Research Objectives

A list of potential topics, which are very important issues in cooperative system design, are given below.

Topic 1. Resource Allocation. Once the multiple access schemes are determined in a system, each source and relay node can be allocated with different resources in terms of time, frequency, number of codes, etc. To design a contention-based cooperative transmission protocol, effective resource allocation can be achieved by employing a smart backoff mechanism.

Topic 2. Power Adjustment. Different levels of transmission power can be allocated to source and relay nodes to optimize different performance criteria according to channel conditions. The achieved optimal performance will be strongly affected by the availability of feedback from a receiver back to its transmitter. There is a tradeoff between performance and overhead that needs to be balanced with regard to resource allocation in cooperative systems.

Topic 3. Relay Selection. In cooperative communication networks with multiple potential relays, we need to determine which relay(s) to cooperate with. The decision

can be made based on average or instantaneous relay channel conditions. In a distributed wireless network without a central controller, relay selection is a fairly challenging task in the cooperative scheme design.

Topic 4. Mobility of Relays. In a planned cooperative system, it is possible to allocate optimal relay positions while planning. Whereas in mobile networks, the mobility of the relays is also an important factor to consider. The relay mobility will strongly impact the complexity and the performance of a cooperative system.

Topic 5. Traffic Scheduling. In cooperative networks, both original traffic from users and extra relayed traffic need to be scheduled. In certain situations, the relayed traffic requires higher priority over the original traffic, and in other cases, it is the other way around. In addition, there are packets from different relays with the same information that need to be dealt with in coordinated way. Traffic scheduling and medium access control in traditional networks are already complicated, and these issues introduced by cooperative communications add considerable extra complexity.

Topic 6. Cooperative Networking. The application of cooperative communications needs to be extended to multi-hop scenarios. However, a lot of challenges will be confronted in a cooperative multi-hop network. Questions like how to explore cooperative diversity from the routing layer, or how to combine routing with the underlying cooperative systems, need to be answered. Therefore, it is imperative to have a carefully designed cross layer solution in cooperative networking, because any gains due to cooperation at the physical layer can dissipate rapidly if not handled properly at the medium access and higher layers.

Topic 7. Backward Compatibility. Most cooperative systems are proposed independently without considering the compatibility with the existing communications systems. This certainly hinders the applicability of cooperative communications in real life. Hence, it is of pragmatic importance to design cooperative communication systems while keeping the compatibility to the current hardware and protocols. This implies that instead of searching for a general cooperation solution, cooperative schemes should be tailored for specific application scenarios.

Topic 8. Performance Evaluation. There are different approaches to evaluate a novel cooperative scheme. Firstly, the benefits of cooperative communications can be

demonstrated through theoretical analyses in terms of Signal-to-Noise Ratio (SNR) benefits, outage probability and coverage extension. Secondly, the performance of cooperative schemes such as transmission reliability and network throughput can be illustrated through simulations using simplified network scenarios. Thirdly, the correctness and the feasibility of a proposed cooperative protocol can be verified through formal methods, as explained later in this chapter and in Chapter 2. Most proposed cooperative systems focus on the theoretical analysis and network simulations. However, in order to know the real performance of a cooperative system and promote the application of cooperative communications in reality, the evaluation has to be carried out by implementing testbeds and measuring the performance in real-life.

Topic 9. Alternative Ways to Explore Cooperation Benefits There are also possibilities to explore the benefits of cooperation in many other different application scenarios. For instance, cooperation can be used when making joint decisions in cognitive radio networks; or used for improvement when network dependability is concerned.

In this dissertation, we aim at solving several of the above mentioned issues aiming at specific network scenarios, such as different use cases in WLANs. Our work especially focuses on cooperative design based on Carrier Sense Multiple Access with Collision Avoidance (CSMA/CA), which is widely used in today's mass-market applications. The main objective of this dissertation is to propose cooperative schemes from the Medium Access Control (MAC) layer perspective, dealing with some of the interesting topics listed in the preceding part of this section, e.g., resource allocation, relay selection, cooperative networking, backward compatibility, and performance evaluation. More specifically, the following research goals are intended to be achieved.

1. Designing cooperative schemes that comprehensively address the important cooperative issues from the MAC layer perspective, while keeping compatibility with legacy physical layer techniques.
(Topics 1, 3, 5, 7, 8 covered)
2. Cooperative scheme optimization under different network scenarios, e.g., optimization of the relay selection scheme, power allocation and relay deployment position.
(Topics 1, 2, 3, 5, 7, 8 covered)

3. Formal verifications of the proposed protocol, verifying its correctness and the feasibility, as a further step towards real-life implementation.
(Topics 5, 7, 8 covered)
4. Evaluation of different existing categories of cooperative MAC schemes with regard to transmission reliability, throughput and energy efficiency.
(Topic 8 covered)
5. Cooperative networking in wireless multi-hop ad hoc networks, combining cooperative MAC schemes with routing protocols.
(Topics 6, 7, 8 covered)
6. Cooperative schemes which support multiple relays to transmit simultaneously, dealing with key cooperation issues, such as relay selection and space-time code allocation in specific network scenarios.
(Topics 1, 3, 5, 8 covered)
7. Network throughput enhancement in dense WLAN networks by enabling interference-tolerant co-channel concurrent transmissions using position information from cooperative carrier sensing.
(Topics 1, 3, 5, 7, 8, 9 covered)

1.6 Performance Parameters and Evaluation Methodology

1.6.1 Performance Parameters

To evaluate the designed cooperative relaying systems, it is necessary to employ various performance parameters. The following metrics are used in our study to evaluate and optimize system performance.

Average Packet Delivery Ratio. The instantaneous Packet Error Rate (PER) is calculated assuming a given channel realization and an average noise level. In slow fading channels (i.e., the baseband signal symbol period is shorter than the channel coherence time), the average PER can be calculated and used for system characterization. Whilst Symbol Error Rates (SERs) can be calculated in closed forms using the moment generating function approach [32], exact Bit Error Rate (BER) and

PER expressions are generally not easy to derive. Approximations and asymptotic expressions are therefore typically employed in the derivation of PERs.

The average Packet Delivery Ratio (PDR) at the MAC layer, defined in our study as the ratio between the number of successfully transmitted packets and the number of total packets generated from its upper layer, is one of the most important quantities in real-life systems. When Automatic Repeat reQuest (ARQ) is applied, PDR can be expressed as follows:

$$PDR = 1 - \prod_{i=0}^m PER_i, \quad (1.1)$$

where PER_i is the PER value at the transmission attempt i , and m is the maximum number of retransmissions.

Throughput. Using the average PDR values, the average system saturation throughput can be obtained. This parameter gives system designers insight into how many bits per second can be offered to users when using a cooperative communication scheme compared with a traditional scheme.

The normalized system saturation throughput, denoted by η , is defined as the number of successfully transmitted payload bits per time unit. In an IEEE 802.11 based network, according to [33], η can be calculated as $E[G]/E[D]$, where $E[G]$ is the number of payload information bits successfully transmitted in a virtual time slot, and $E[D]$ is the expected length of the virtual time slot. A virtual slot is the time interval between two consecutive backoff counter decrements of non-transmitting stations [34].

Delay/Latency. Delay typically comprises the time a packet spends in the buffer queue of the device, the time required to get it successfully delivered via the wireless channel to the destination, and the time needed to process it. In our study, we only focus on the second element, the successful delivery time, which includes the contention or transmission time, as well as retransmissions in the case of delivery failure.

Energy Efficiency. Many wireless devices are powered by batteries, especially in wireless ad hoc and sensor networks. Therefore, energy efficiency becomes a critical metric in performance evaluation of such wireless networks. In our study, energy

efficiency is defined as the number of successfully delivered information bits per consumed joule of energy.

1.6.2 Methodology and Tools

To investigate the above introduced performance parameters of the proposed cooperative schemes, the following tools or approaches are used in simulations:

- MATLAB for MAC layer scheme simulations.
- C++ programming for physical layer simulations.

In addition, a MAC-PHY interface through physical abstraction algorithms is developed in MATLAB and used in our cross layer simulations [35].

Other than experimentation in real-life scenarios, another well-known approach to verify the correctness and the feasibility of a new protocol or system is using formal methods. Model checking is one such method, which consists of constructing a computer tractable description (formal model) of the protocol and then using a specific automatic (or semi-automatic) analysis technique to check the satisfaction of a given set of critical properties. The following tools or languages are used to verify the correctness and the feasibility of the proposed protocols.

- Specification and Description Language (SDL) for protocol modeling.
- Process or Protocol Meta Language (PROMELA) for protocol functionality verifications.

1.7 Organization of the Dissertation

This dissertation is grouped into two parts. Part I consists of Chapters 1-6 and provides an overview of the PhD work. Part II consists of Papers A-G, listed in the first set of the publication list. The structure of the whole dissertation, as well as the association between the chapters in Part I and the included papers in Part II, are summarized as follows, and illustrated in Fig. 1.4.

- **Chapter 1** gives general information about cooperative communications in wireless networks. The motivation and objectives of the PhD work are presented. In the end, the organization of the whole dissertation is provided.

- **Chapter 2** discusses cooperative MAC protocol design in CSMA/CA based wireless networks. A multi-relay cooperative retransmission MAC protocol, named as C-ARQ, which addresses three key issues of cooperative MAC design (Paper A), is introduced. Its relay selection scheme is optimized for different network requirements based on the overall performance analysis in a single-relay case (Paper B). Furthermore, the correctness and the functionality of C-ARQ are verified using formal methods (Paper C).
- **Chapter 3** summarizes and evaluates different approaches of cooperative schemes at the MAC layer (Paper D). Based on that, cooperative networking solutions combining routing with cooperative MAC schemes are proposed (Paper E).
- **Chapter 4** covers cooperative MAC design with multiple simultaneously transmitting relays. Two important issues, relay selection and distributed space-time code allocation, are addressed in our proposal (Paper F).
- **Chapter 5** describes how to enhance network throughput by enabling co-channel transmission concurrency in a dense WLAN with multiple APs. Position information from cooperative carrier sensing can be used to make decisions about whether or not to allow concurrent transmissions and how to schedule concurrent traffic flows (Paper G).
- **Chapter 6** summarizes the contributions of the dissertation and discusses the limitations of our research work, and then points out a few directions for future work.

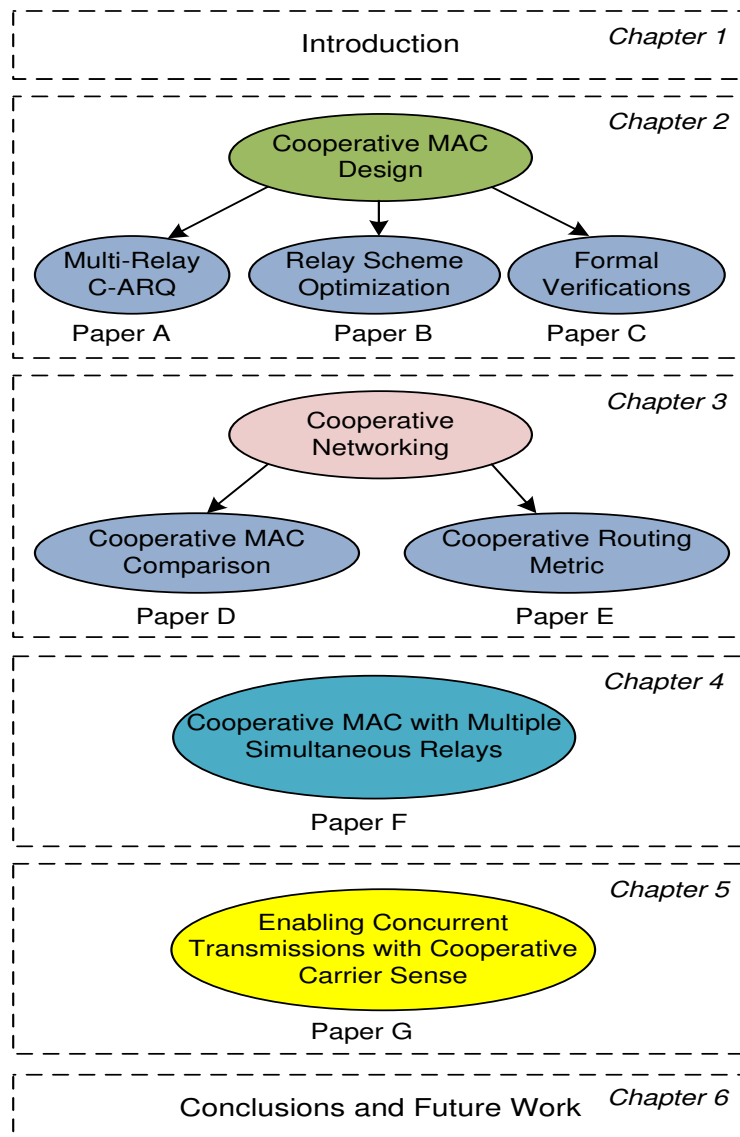

FIGURE 1.4: Dissertation Outline.

COOPERATIVE MAC PROTOCOL DESIGN

In this chapter, a general introduction of cooperative MAC design is given in the beginning, where different categories of cooperative MAC schemes are presented. After that, a new cooperative retransmission protocol, C-ARQ, is introduced. Its relay selection scheme is optimized based on the overall performance analysis in the single-relay case. In the end, a formal verification of the protocol are presented.

The theory behind cooperative communications has been studied in depth, and significant improvement of system performance has been demonstrated in terms of SNR gains, network coverage and energy efficiency [36]. However, when it comes to the implementation of cooperative communications in a network, cooperative MAC protocol design is of indispensable significance as well.

Recently, cooperative MAC design in distributed wireless networks has attracted more and more attention. For instance, Code Division Multiple Access (CDMA) has been favored by many researchers [37]~[39] to support simultaneous channel access in cooperative transmission schemes. However, many of today's mass-market applications based on IEEE 802.11, 802.15.4 etc. are using CSMA/CA for access control, where simultaneous transmissions of multiple stations are impossible. In this chapter, we are particularly interested in cooperative MAC design for CSMA/CA based wireless networks.

2.1 Cooperative MAC Design

From the MAC layer perspective, three key questions need to be answered in cooperative communications: i.e., when to cooperate (opportunistic cooperation), whom to cooperate with (relay selection) and how to protect ongoing cooperative transmissions (message procedure design).

Firstly, since the wireless channel condition varies from time to time, a source node may not always need help from relay nodes. Therefore, when cooperative transmissions should be enabled needs to be investigated.

Secondly, one or more relay nodes need to be selected among multiple potential relays in the network. In a distributed network where there is no central controller coordinating data transmissions of all the relays, relay selection becomes an important and challenging task. Without an efficient relay selection scheme, collisions might happen when several potential relays are contending for channel access at the same time, and network performance will be degraded as a consequence.

Thirdly, MAC protocols should be carefully designed to protect all ongoing transmission sequences against potential collisions from any other nodes in the vicinity.

In the context of cooperative MAC in WLANs, the proposals in the literature can be divided into three different categories: cooperative retransmission MAC, multi-rate cooperative MAC and space-time relaying.

2.1.1 Cooperative retransmission

Based on the principle that that cooperation is initiated only after the direct source to destination transmission fails, the concept of distributed cooperative ARQ has been proposed and studied in a few recent publications. This type of cooperation is referred to as *cooperative retransmission*, which is also the focus of this chapter to be discussed in more details in the following sections.

Persistent Relay Carrier Sensing Multiple Access (PRCSMA) [42] is claimed to be the first protocol to apply distributed cooperative automatic retransmission to wireless networks. According to the PRCSMA scheme, all stations are invited to become active relays as long as they meet certain relay selection requirements. Multiple relays attempt to access the channel in the cooperative phase following the Distributed Coordination Function (DCF) protocol [43]. However, the resulted long defer time and random backoff time at each relay may lead to lower bandwidth efficiency.

2.1.2 Multi-rate cooperative MAC

Another group of cooperative MAC protocols use relays node to mitigate the throughput bottleneck caused by low data rate stations in the network. In these schemes, a relay node works as a virtual-hop node between the source and the destination. Each source node selects either the direct transmission link or the source-relay-destination transmission link in order to achieve maximal end-to-end throughput. We refer to this type of MAC as *multi-rate cooperative MAC*, also known as *virtual-hop cooperative MAC*.

A representative multi-rate cooperative protocol is CoopMAC [40], where the relay node is adopted to forward its data packet when the geometrical mean of the data rate between the source and relay nodes and the data rate between the relay and destination nodes is higher than the data rate on the direct link.

2.1.3 Space-time relaying

Different from the above two categories, space-time relaying allows simultaneous transmissions of multiple relay nodes with space-time coding, as in a virtual MIMO system. The proposal in [44] is an example of cooperative MAC protocols in this category. In this dissertation, Chapter 5 is dedicated to discuss space-time relaying MAC schemes.

2.2 Cooperative Retransmission in WLANs

One typical scenario for cooperative communication applications is WLANs in office environments. It has been observed in [45] that wireless channels exhibit strong time correlation and negligible spatial correlation in such environments. The experiments in [45] were set up with one sender and two receivers, which were placed close to each other at a distance of five meters. A two-state Markov chain is built to model the channel with time correlation, as illustrated in Fig. 4. In this model, there are two states, "1" and "0", representing that a packet has been received correctly or not, respectively. Let p_{ij} denote the transition probability from state i to state j for two consecutive packet transmissions, where $i, j = 0, 1$. The following transition probabilities are obtained from the experimental results: $p_{10} = 0.001$, $p_{11} = 0.999$, $p_{00} = 0.97$, and $p_{01} = 0.03$. These values indicate that the probability of another successful data packet transmission after a successful one on the same channel is as high as 0.999 and the probability of a successful

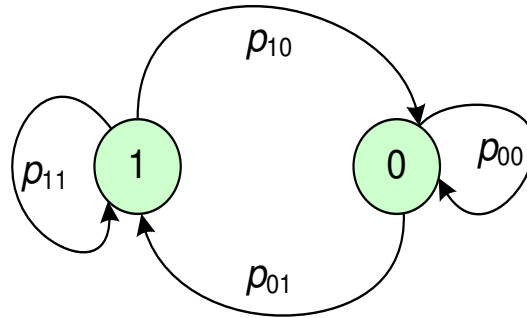

FIGURE 2.1: Channel Model with Markov Chain.

transmission after an unsuccessful one is as low as 0.03. Therefore, if the first data transmission fails, great advantages can be achieved by forwarding information through a different channel (using a relay node) compared to resending the packet from the source node through the original channel.

Motivated by the above observation, a cooperative retransmission scheme is designed in Paper A, which exploits the rich spatial diversity instead of the inefficient temporal diversity in slow varying environments.

2.3 Cooperative Retransmission MAC Protocol: C-ARQ

In the C-ARQ protocol proposed in Paper A, the above mentioned three key issues concerning cooperative transmissions at the MAC layer are handled efficiently with a minimum cost of resources. Firstly, cooperative transmission is initiated only when the direct transmission fails. In this way, unnecessary occupation of channels by relay nodes and waste of system resources is avoided. Secondly, the relay nodes are sorted with different backoff durations before data transmission according to the instantaneous relay channel quality, and the relay node with the best relay channel quality will be selected automatically to forward the data packet first. Finally, the cooperative transmission sequences are specifically designed to give the relay nodes higher priority for channel access and to protect ongoing cooperative retransmissions.

The relay nodes in C-ARQ are selected in a distributed manner by using the instantaneous channel condition obtained through a Call For Cooperation (CFC) packet sent from the destination node. After the cooperative phase starts, each relay candidate starts

its timer with an initial value of:

$$T_i = \left\lfloor \frac{SNR_{low}}{SNR_i} \frac{T_{up}}{slottime} \right\rfloor, \quad i = 1, 2, \dots, n \quad (2.1)$$

where T_i is the backoff time at relay node R_i , defined as an integer in number of microseconds; $\lfloor \cdot \rfloor$ in this dissertation stands for the floor function which maps a real number to the greatest integer smaller than it; SNR_i is the SNR value (dB) of the CFC packet received at R_i ; SNR_{low} is the threshold of SNR_i for R_i to participate in cooperative retransmission; T_{up} is the upper bound of the backoff time for relay candidates; and n is the number of the relay nodes in the network. More details about Eq. (2.1) can be found in Paper A.

Through analysis and simulations we demonstrate that the C-ARQ protocol generally outperforms its counterparts, the original DCF and PRCSMA protocols, in terms of both throughput and packet delivery ratio. The improvement becomes more evident when more potential relay nodes are available in the network. Moreover, the relay selection mechanism in C-ARQ is so efficient that the average number of retransmissions needed for successful packet delivery is not more than one in most of the simulated scenarios.

However, collisions may happen among relays in a dense network. The reason is that T_{up} from Eq. (1) is set as $DIFS - SIFS$ in Paper A, which indicates that the scheme can only distinguish at most $\left\lfloor \frac{DIFS - SIFS}{slottime} \right\rfloor$ relays. DIFS and SIFS stand for DCF InterFrame Space and Short InterFrame Space.

In order to solve this problem, three techniques are proposed and studied in depth, namely, P-persistent Cooperative Automatic Repeat ReQuest (P.C-ARQ), Increased Threshold Cooperative Automatic Repeat ReQuest (IT.C-ARQ) and Extended Back-off Cooperative Automatic Repeat ReQuest (EB.C-ARQ). EB.C-ARQ outperforms the other two in throughput and PDR performance due to its high accuracy of relay distinguishing capability. Even in a dense network with fifty relay nodes, the peak value of the collision ratio remains very low with EB.C-ARQ. Furthermore, no parameters need to be adjusted in EB.C-ARQ in different network conditions.

2.4 Relay Scheme Optimization in Single-Relay C-ARQ

As already mentioned, the simulation results in Paper A show that with C-ARQ, only one cooperative retransmission is sufficient for successful packet delivery in many cases.

Besides, it has been proven in [46] that one optimal relay is able to achieve full cooperative diversity with an efficient relay selection scheme. Therefore, in the simplified single-relay C-ARQ version, only a single relay node is selected for cooperation in order to reduce the cooperation overhead.

In single-relay C-ARQ, the best relay node is selected in a similar way, which is using different backoff durations at each relay node before its packet retransmission. The mapping relation from SNR_i to T_i is implemented as shown in Table 2.1, where $\vartheta_j, j = 1, 2, \dots, m$ are the threshold values for SNR_i to have different backoff time, and $\vartheta_1 \leq \vartheta_2 \leq \dots \leq \vartheta_m$. ϑ_1 is the threshold value for the relay candidate to cooperate. Each relay candidate gets its backoff time T_i from the table using its measured SNR value of the CFC packet, SNR_i , as its index. The relay with the highest SNR_i will get the first time slot and transmit first.

TABLE 2.1: Mapping Table from SNR to Backoff Time in Single-relay C-ARQ.

| | | | | |
|---------|-------------------------|----------------------------------|---------------------------|------------------------------|
| SNR_i | $[\vartheta_m, \infty)$ | $[\vartheta_{m-1}, \vartheta_m)$ | $[\vartheta_{m-2}, \dots$ | $(\vartheta_1, \vartheta_2)$ |
| T_i | first slot | second slot | ... | $DIFS - SIFS$ |

Different from multi-relay C-ARQ, the complexity in the single-relay case is significantly decreased, making it possible to derive a complete closed-form expression for the performance analysis. Based on the performance analysis, an optimal mapping scheme from relay channel condition to backoff time can be obtained to reduce the collision probability. Therefore, an optimal relay selection scheme is proposed in Paper B to improve the performance of single-relay C-ARQ in a dense network.

In Paper B, a complete analysis of the single-relay C-ARQ performance with impairment caused by collision is presented. The throughput, η , is expressed as a function of $\vartheta_j, j = 1, 2, \dots, m$, with given network topology and channel conditions. Based on that, the optimal values of ϑ_j are derived to maximize system throughput. The optimization problem can be formulated as follows:

$$\begin{aligned}
 & \text{Maximize } \{\eta(\vartheta_j, m)\}, j = 1, 2, \dots, m \\
 & \text{subject to } : \vartheta_{j+1} - \vartheta_j \geq 0, j = 1, 2, \dots, m, \\
 & m = \left\lfloor \frac{DIFS - SIFS}{slottime} \right\rfloor.
 \end{aligned} \tag{2.2}$$

The analysis and simulation results in Paper B coincide with each other, and significant throughput enhancement is observed when the proposed optimal relay scheme is

applied. Besides, the relay selection scheme in the single relay case can also be optimized to maximize system performance in terms of other parameters. For instance, in another paper [47], the scheme is optimized to achieve highest energy efficiency.

Furthermore, the optimal mapping scheme in Paper B applies to many protocols with similar problems. In fact, collision among relays is a common problem that exists in a category of distributed path selection protocols using different lengths of backoff durations [48] before transmission. When more than one relay node have the same shortest backoff time, collision happens. For example, in the CoopMAC-Aggregation protocol [49], different slots are allocated to different helper groups according to the effective data transmission rate in each relay link. In this case, collisions caused by multiple relay nodes with similar effective data rates also lead to serious impairment of the protocol performance in dense networks.

2.5 Formal Verification of Cooperative Retransmission Protocols

In this section, model checking, which is a widely used approach to verify the correctness and the feasibility of a new protocol, is introduced. After that, a formal verification of the proposed cooperative protocol is presented.

2.5.1 Model checking with SDL, SPIN and PROMELA

Analyzing a protocol with model checking starts with an abstract description of the protocol with the main features that could produce execution errors; then specifying the reliability requirements with a property-oriented language; and finally producing the reachability graph including all the execution paths for the model in order to check whether these paths satisfy the requirements.

Testing the correctness of a system using formal methods can for example be accomplished using the SPIN tool [50]. The description of the system's possible behavior is the input, along with the requirements (the desirable behavior) [51]. Knowing these parameters, the tool can perform verifications of the model.

SPIN accepts design specifications written in the verification language PROMELA [52], and correctness claims can be specified in the syntax of standard Linear Temporal Logic (LTL). SPIN can produce validators that can be further used in different modes. For small to medium size models the validators can be performed within an exhaustive

state space. For larger systems, the validators are able to perform a non-exhaustive scan using much less memory, but still retain a good coverage of the state space [53].

SDL is another tool that is widely used in the telecommunication field for system design, prototyping, testing and verification. It can be used to specify and visualize a formal model in the form of state machines that can be executed for testing and verification purposes.

The SDL-Forum which is responsible for the SDL language describes it as follows [54]:

“The basis for description of behavior with SDL is communicating extended state machines that are represented by processes. Communication is represented by signals and can take place between processes or between processes and the environment of the system model. Some aspects of communication between processes are closely related to the description of system structure. An extended state machine consists of a number of states and a number of transitions connecting the states.”

2.5.2 Formal verification of C-ARQ

In Paper C, the correctness and the functionality of the cooperative retransmission MAC protocol in Paper A are verified using the above mentioned formal methods.

Firstly, the SDL language is used to specify and visualize a formal model for the C-ARQ protocol. Four processes are generated to model the different roles of the nodes in cooperative networks: the source node (S), the destination (D), the optimal relay node (R) and the other relay node (H). The simulation results in diverse channel condition configurations are consistent with the protocol specification.

Secondly, PROMELA is employed along with the SPIN model checker to verify the integrity and the validity of the C-ARQ protocol. To represent the correctness condition for the C-ARQ protocol in LTL, it is specified that the protocol should deliver the data packet correctly if there has been a functional path (direct or indirect via relays) between the source and the destination. The verification is carried out through never-claims. No invalid end-states have been found and the proposed claim holds true in the exhaustive verification operations. Therefore, the integrity and the validity of the C-ARQ protocol are verified.

In this way, Paper C has demonstrated the applicability of formal model checking to verify the functionality of the C-ARQ protocol. Furthermore, the formal model can be refined with more logic to verify other functionalities of the protocol.

COOPERATIVE NETWORKING IN MULTI-HOP AD HOC NETWORKS

In this chapter, cooperative networking in wireless ad hoc and sensor networks is discussed, including the physical layer, the MAC layer and the routing layer. First, different MAC schemes are introduced and evaluated with comparison to each other. Thereafter, a cooperative routing solution developed based on these cooperative MAC schemes is introduced.

3.1 Multi-hop Networks and Cross-layer Cooperation

In the previous chapter, we introduced cooperative MAC design and described significant performance improvements from using proper cooperative transmission schemes at the MAC layer. However, to implement cooperative communications in a multi-hop wireless network, the cooperative MAC schemes we discussed in Chapter 2 are not sufficient and need to be integrated with layer 3 routing protocols.

Multi-hop networks such as ad hoc networks have been active research topics in both academia and industry for many years. Different types of multi-hop wireless networks are deployed pervasively in various environments such as office buildings, wildlife reserves, battle fields and so on. It is natural to implement cooperative communications in wireless ad hoc networks due to its open channel environment and peer-to-peer transmission features, i.e., a packet addressed to a receiver can be received by the neighboring

nodes surrounding the sender. Therefore, it is beneficial to utilize the information obtained from the surrounding nodes to improve the network performance. Furthermore, how the cooperative benefits obtained from lower layers can be reflected at the routing layer remains an interesting topic.

Cross layer cooperation design involves interactions between the physical layer, the MAC layer and the routing layer. First of all, wireless channels are susceptible to fluctuations in terms of path loss, fading, etc., which can seriously degrade transmission reliability. Several important issues at the physical layer need to be handled properly to mitigate the impairments from wireless channels, e.g., modulation and coding scheme adaption, transmission power adjustment, space-time code design and allocations, etc. Secondly, it is of importance at the MAC layer to allocate resources such as the number of time slots, and to coordinate transmissions from different nodes and avoid collisions in case of contention based protocols. Furthermore, the choice of cooperative schemes and relaying nodes is closely related to the overall performance. Finally, at the higher level, optimal paths from source to destination have to be established taking cooperative communications into consideration.

In this chapter, different cooperative MAC schemes are investigated first and a cooperative routing solution is proposed based on that.

3.2 Comparison of Cooperative MAC Schemes

As mentioned in Chapter 2, two types of cooperative MAC schemes exist in the literature: virtual-hop relay (multi-rate cooperation) and cooperative retransmission. It is sensible to investigate both types of schemes and compare their performance. Therefore, a complete performance comparison is performed in Paper D, using EMR [41] and Cooperative MAC (CoopMAC) [40] as the representatives of the virtual-hop schemes and Automatic Cooperative Retransmission (ACR) MAC [55] as the representative of the cooperative retransmission schemes. The performance evaluation and comparison in terms of throughput, packet delivery rate and energy consumption are carried out within a simple three-node network model with Rayleigh fading channels.

Different virtual-hop relay schemes have different criteria to decide whether the source-relay-destination link provides better performance than the direct channel. In the

CoopMAC protocol [40], the relay node, R, is adopted to forward its data packet when:

$$\frac{1}{R_{sr}} + \frac{1}{R_{rd}} < \frac{1}{R_{sd}}. \quad (3.1)$$

where R_{sr} , R_{rd} and R_{sd} are the data rates on the channel from source to relay, from relay to destination, and from source to destination respectively. These data rates are determined according to the corresponding channel conditions.

While in EMR, the relay link is selected when it can provide higher effective throughput, which is obtained based on the assumption that no data corruption occurs in either the source-relay-destination link or the source-destination link [41].

Please note that E_t/N_0 is used to represent the channel conditions in our simulation environments, where E_t is the transmitted energy per bit at the transmitter and N_0 is the spectral power density of the Gaussian white noise at the receiver. The reason that we adopt this symbol can be explained with a simple network scenario with one receiver and two transmitters A and B. Assume that transmitter A has a longer transmission distance to the receiver than transmitter B's and correspondingly suffers more severe path loss during the transmission. The transmission power is fixed and identical for all nodes in our simulations. The result is that the average strength of the received signal from B is higher than from A, and hence different SNRs and decoding performance will be perceived at the receiver. Therefore, in order to evaluate the performance of different schemes in a network scenario with multiple potential transmitters, it is more sensible to illustrate the performance of each scheme using a parameter to represent the transmitted energy per bit to noise ratio, i.e., E_t/N_0 , instead of E_b/N_0 .

The simulation results from Paper D show that data transmissions do not always benefit from cooperation. In some scenarios, the direct transmission is in fact optimal, especially when energy consumption is concerned. In general, C-ARQ outperforms the other schemes in PDR performance at a cost of higher energy consumption. CoopMAC and EMR are successful with throughput enhancement, as well as more energy efficient. The performance curves of EMR and CoopMAC coincide with each other, indicating that the virtual-hop relay schemes are not sensitive to their cooperation requirements.

3.3 Cooperative Routing

The results from Paper D have clearly demonstrated the importance of cooperation decisions, such as cooperative MAC scheme selection and relay node selection. Therefore, in a multi-hop ad hoc network, besides setting up the optimal path from source to destination in a traditional way, cooperative communications also need to be integrated into routing operations to further improve network performance.

Although significant efforts have been made on the study of cooperative systems, there has been very little work on cooperative routing. Some of the relevant studies focus on the theoretical analysis on routing and cooperative diversity [56] [57]. With regard to the implementation of a cooperative routing protocol, the theoretical optimal route is too complicated and therefore unsuitable for the current status of ad hoc and sensor networks [58].

An alternative way to extend cooperative communications to the routing layer (other than designing a brand new cross layer cooperative routing protocol) is to design routing metrics that reflect potential cooperation gain, and find optimal paths based on the cooperative metrics. Different from other proposals which often assume pre-selected relays [59] [60], Paper E proposes a cooperative routing solution that comprehensively deals with cooperative transmission decision, cooperative scheme selection and relay selection. The proposed cross-layer cooperative solution is carried out by using various cooperative metrics instead of traditional routing metrics, which is explained in details in the following section.

3.4 Cross Layer Routing Metric

As discussed above, with cooperative routing metrics proposed in Paper E, not only the best path for data transmission can be selected, but also the best cooperative MAC scheme and the best relay candidate can be determined.

In our cooperative networks, a new cooperative metric is calculated for each potential relay and each cooperative transmission scheme for each link. The optimal MAC scheme with the optimal relay node is selected by comparing these metric values. Using the optimal metric value instead of the traditional non-cooperative metric value for each link at the routing layer, new optimal paths are established in multi-hop ad hoc networks, by taking into account the cooperative benefits from the MAC layer. The studied metrics

include PDR, throughput and energy consumption efficiency, according to the requirements in different network scenarios. Note that these new cooperative routing metrics are compatible with the traditional routing metrics. Simulations are made in a simple topology to show the performance improvement from the proposed cooperative routing metrics.

The numerical results from Paper E show that cooperative communication is effective in terms of PDR performance enhancement but less effective when throughput enhancement is of interest. Furthermore, cooperative communications have no advantage over traditional transmissions with regard to energy efficiency in the investigated scenarios.

COOPERATION WITH MULTIPLE SIMULTANEOUS RELAYS

Cooperation that allows simultaneous transmissions of multiple relays, also known as space-time relaying, is discussed in this chapter. After the introduction of different approaches for cooperation implementation, the special category of distributed MIMO is introduced. Cooperative transmission schemes with multiple transmitting relays are discussed thereafter, followed by a solution for relay selection and code allocation.

In Chapter 1, we have classified cooperative systems into different categories according to some important factors, such as whether to use transparent relaying or regenerative relaying, how many relays are selected, whether the relays operate in serial or in parallel, whether the cooperation is unilateral or bilateral, and whether simultaneous transmissions of multiple relays are supported.

The cooperative systems discussed in Chapter 2 belong to regenerative, supportive serial relaying in CSMA/CA based wireless networks. In this chapter, we will focus on another category, which is distributed space-time relaying.

4.1 Space-Time Relaying

To get a better understanding of space-time relaying, also known as virtual MIMO, seminal works on traditional MIMO systems will be introduced first.

The earliest ideas about multiple antenna system date back to the 1970s. Much interest in this area has been ignited by the pioneering work in [7], [61] and [62]. It has been predicted that considerable spectral efficiency improvements can be provided in wireless systems with multiple antennas when channels exhibit rich scattering. In the Bell Laboratories Layered Space-Time (BLAST) system introduced in [63], multiple signal streams are allocated to different transmit antennas at the transmitter side, and then iteratively extracted at the receiving side. The BLAST concept has ever since been extended to more sophisticated systems, a good summary of which can be found in [67]. Later, a very appealing transmission diversity scheme known as Alamouti Space-Time Block Code (STBC) has been introduced, in which two complex signal streams from two transmission antennas are orthogonally encoded, achieving code rate one [64]. This work was then mathematically enhanced in [65], where various important properties of space-time block codes are essentially exposed. Thereafter, the construction of suitable space-time trellis codes was shown in [66] with proven diversity and coding gain. There have also been several publications on beamforming, which is a combination of radio signals from a set of small non-directional antennas to simulate a large directional antenna. It can be used in communication to dynamically aim an antenna at the signal source or destination to reduce interference and improve communication quality [72][73].

Based on the studies on different MIMO techniques, space-time relaying is proposed [63] ~ [66]. It has been demonstrated in [68] and [69] that cooperation yields full spatial diversity, which allows drastic transmission power savings at the same level of outage probability. Specific distributed space-time coding schemes have also been suggested [70] [71]. Distributed space-time trellis codes have been designed that maximize the performance of the system from either the direct link or the relaying link. Furthermore, distributed beamforming has also been introduced [74]. In [75], a distributed beamforming strategy is developed for the case where the relaying nodes cooperate to build a beam towards the receiver with perfect channel information under individual relay power constraints.

4.2 Simultaneous Multi-relay Cooperative Scheme

Besides the physical layer studies of distributed MIMO schemes discussed above, there also exist a few publications regarding the applications of distributed MIMO in wireless networks. For example, in [77], multiple cooperative sensors are implemented as a

virtual MIMO system based on STBC to provide transmission diversity in WSNs. Distributed beamforming is used in [78] for distributed wireless ad hoc sensor networks. Another virtual MIMO transmission scheme based on V-BLAST in [79] is applied to multi-hop transmissions to maximize network lifetime.

In the above mentioned schemes, each node emulates a specific antenna of a MIMO system based on the assumption that the space-time code allocated for each relay is known beforehand. However, to apply distributed space-time codes in practice, certain code distribution algorithms are required to assign code matrix columns to individual collaborators. In fact, code allocation is an important but challenging task in distributed cooperative networks.

In order to solve the distributed code allocation issue, a novel cooperative communication scheme is proposed in Paper F aiming at a clustered network scenario within one-hop transmission. The proposed scheme comprehensively deals with cooperation issues, including distributed relay selection, code allocation and transmission coordination. Three phases potentially exist in the proposed cooperative transmission scheme: direct transmission, relay declaration and cooperative retransmission. The relay declaration phase and the cooperative retransmission phase happen only if the initial direct transmission fails. Only relays with successful reception of the data packet from the direct link can participate in packet forwarding. The relay declaration procedure is designed to rank and select relays according to their instantaneous relay channel quality. Following this ranking sequence, the space-time codes can be assigned to each collaborator correspondingly. The procedure will be explained in more details in the following section.

4.3 Relay Selection and Code Allocation

According to the proposed scheme in Paper F, the relay nodes that have received the packet from the direct transmission successfully will declare themselves to the cluster network, using different backoff time intervals.

The declaration procedure is done by allowing a relay candidate to send a short signal over the wireless channel, which can be a tone within the allotted spectrum of the wireless network [49]. Each qualified relay node needs to back off for time interval Δ_i

before sending out its declaration signal. Δ_i is defined as:

$$\Delta_i = \frac{SNR_{low}}{SNR_i}(\text{DIFS} - \text{SIFS}), i = 1, 2, \dots, N, \quad (4.1)$$

where SNR_i and SNR_{low} have the same meaning as in Eq. (2.1) in Chapter 2.

It is obvious that the best relay node, which has the highest received signal strength, will have the shortest backoff time, and then firstly send its declaration signal to the channel. All the other relay candidates in the network will declare themselves similarly. In this way, all the relay nodes are ranked in a descending order of their instantaneous relay channel quality. Similarly to the relay selection scheme introduced in Chapter 2, the mapping from SNR to backoff time can also be implemented through a look-up table, and the boundaries in the table can be optimized to minimize the probability of two or more relays using the same backoff time interval.

During the relay declaration phase, all nodes in the cluster will be aware of the number of participating relay nodes by detecting all the declaration signals on the channel. Using the number of participating relays, a code matrix of a proper size is selected from a given orthogonal space-time code matrix set, which is pre-defined and known to all nodes in the network. Meanwhile, the nodes can also get their corresponding ranking numbers according to the time sequence of the declaration signals. Using its ranking number, each cooperating node can transmit the packet using its corresponding element in the selected code matrix.

In summary, the proposed scheme in Paper F has efficiently dealt with channel quality based relay selection and space-time code allocation in a coordinated manner. The performance improvement of the proposed scheme in terms of PDR and throughput is demonstrated in Paper F. Furthermore, it suggests that the number of cooperating relays should be small when energy consumption during cooperative retransmissions is taken into consideration.

ENABLING CO-CHANNEL CONCURRENT TRANSMISSIONS IN WLANs

In the beginning of this chapter, the drawbacks of the CSMA/CA medium access scheme used in current WLANs are analyzed. Afterwards, different approaches to mitigate its inefficient channel utilization are discussed. An innovative solution to enhance the network throughput by enabling co-channel concurrent transmissions, is proposed. The last section explains how the novel concurrency scheme performs concurrency decisions and traffic scheduling using position information from cooperative carrier sensing.

5.1 Introduction of WLAN

WLAN deployments have become ubiquitous due to the convenience of wireless access, improved data rates, low end-user equipment cost, and ease of integration with wired networks. For example, WLANs can provide effective broadband coverage at homes, offices, campuses, public venues and government facilities. Furthermore, WLANs can be integrated with cellular networks to provide hotspot coverage for high-speed data services, thus becoming an integral part of next generation wireless communication networks.

The most popular WLANs are based on the IEEE 802.11 standards, marketed under the Wi-Fi brand name. There are two working modes in WLANs: the infrastructure

mode and the ad hoc mode. In an infrastructure WLAN, APs are typically connected to a wired backbone network, and the clients are connected to Internet through APs. In an ad hoc WLAN network, all the nodes directly communicate with each other without the involvement of APs. Wireless stations in WLANs can be mobile devices such as laptops, personal digital assistants, smart phones, or fixed devices such as desktops and workstations that are equipped with a wireless network interface.

With the rapid growth of WLAN deployments, an increasing range of applications are developed. Primarily used for web browsing and e-mail in the early stage, WLANs are now able to support high bandwidth-demanding multimedia services such as video surveillance, video conferences and online games. The need to address larger coverage areas, higher capacity and lower latency, and an ever increasing number of users, triggers the demand for more research attention and efforts to overcome the limitations of traditional WLAN networks.

5.2 Problems with CSMA/CA

In current WLAN networks, DCF is the dominant MAC protocol due to its simple implementation and distributed nature [43].

The DCF mechanism of IEEE 802.11 [43] follows a "listen-before-talk" principle based on CSMA/CA. According to CSMA/CA, a transmitter detects the presence of signals from another station before its transmission. If an ongoing transmission is sensed, the station waits for the transmission in progress to finish before initiating its own transmission. A random backoff scheme is specified thereafter to improve CSMA/CA performance by preventing multiple stations from transmitting at the same time.

However, the carrier sensing mechanism does not consider channel conditions at the receiver. As a result, its transmission decisions are not always correct, especially with the presence of exposed and hidden terminals in the network [80].

In the case of hidden terminals shown in Fig. 5.1 [81], a sender (A) is sending packets to a receiver (B), and a potential sender (C) which is out of the sending range of A intends to deliver packets to B as well. Using CSMA/CA, C determines that B is ready to receive packets since it cannot detect the packet sent from A. However, this is a wrong decision because B is receiving a packet sent from A at the moment. As a result, the packets from both senders will collide with each other at B. Whereas in the exposed

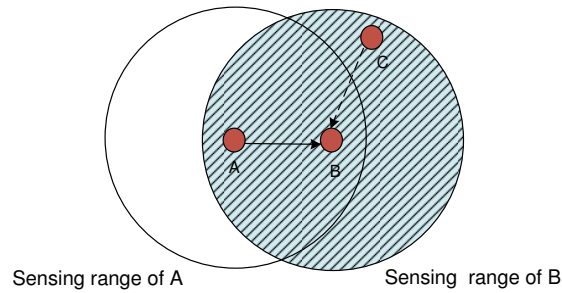

FIGURE 5.1: Hidden Terminals.

terminal case, the decision from CSMA/CA can be wrong in the opposite way [81]. As illustrated in Fig. 5.2, A is sending packets to B, and C intends to send packets to D which is out of the sensing range of B. C can detect the packet from A to B, and therefore decides to defer its transmission. In fact, D is ready to receive its packet since the new transmission and the ongoing transmission do not affect each other's packet reception at their respective receivers. In brief, due to the overcautious channel assessment of CSMA/CA, new transmission attempts are blocked unnecessarily, resulting in overall network throughput degradation.

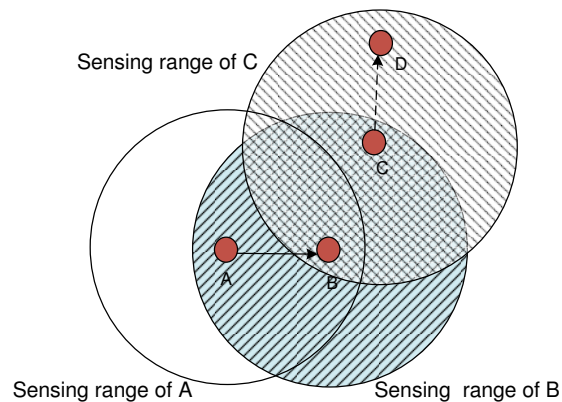

FIGURE 5.2: Exposed Terminals.

To solve the hidden terminal problem, a Request-to-Send / Clear-to-Send (RTS/CTS) four-way handshaking mechanism has been standardized. As shown in Fig. 5.3, the RTS and CTS frames carry information about the duration of the current frame exchange. This information can be read by any listening station in the vicinity, which then updates a Network Allocation Vector (NAV) field containing the duration of the current frame exchange. Therefore, a hidden node that detects either the RTS or the CTS frames, can correspondingly delay its further transmission, and thus avoid collisions.

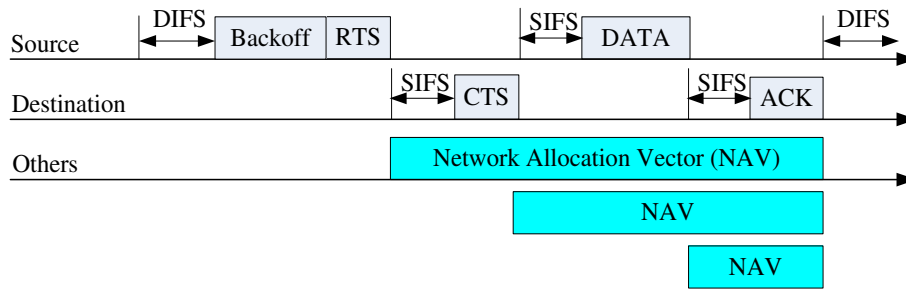

FIGURE 5.3: IEEE 802.11 DCF RTS/CTS Scheme.

On the other hand, the exposed terminal problem, which degrades the network performance in terms of spatial use, has yet to be solved. In fact, it is observed that in a WiFi network with multiple APs, many stations associated to different APs are exposed terminals to each other [82]. This observation indicates that the network performance in infrastructure wireless LANs could be significantly improved by allowing interference-tolerant Concurrent Transmissions (CTs) with accurate decision-making and smart traffic scheduling.

5.3 Transmission Concurrency

There are different approaches in the literature to enhance spatial reuse in order to mitigate the capacity limitations, such as smart antennas [83], transmission power control, and carrier sense adaptation [84]. Among all these possibilities, one innovative solution is to enable concurrency of co-channel transmissions when the reception at their corresponding receivers is affected by each other.

A few solutions have been proposed to enable concurrency in wireless networks [85]~[89], however, each of them has its own limitations. For instance, in a Conflict Map (CMAP) system presented in [87], nodes are allowed to transmit concurrently even if there is a possibility of collision. Then they observe the loss probability to determine whether it is better to deactivate concurrent transmissions or not. This simple solution consumes considerable amount of time to make concurrency decisions and the decisions are not precise enough. There are also concurrent transmission schemes proposed based on the RTS/CTS access scheme [85] [88]. However, extra control packets are often employed to identify and exploit CT opportunities [86]. Some of the proposed schemes assume directional transmissions at both the transmitter and the receiver [85], which is an unrealistic assumption in current WLAN configurations. Others introduce special

code schemes, e.g., symbiotic coding [89], to facilitate concurrency in specific collision scenarios at a cost of system complexity.

Different from those proposals mentioned above, a novel concurrency scheme, named Concurrent CSMA/CA (C^2SMA/CA) is proposed in Paper G. C^2SMA/CA is based on the basic transmission scheme which is widely used in real life to avoid the large overhead of control packets in the RTS/CTS scheme. In C^2SMA/CA , neither control packets nor coding schemes are introduced, nor are directional transmissions required.

5.4 Concurrent Transmission Principle

Based on the observation that concurrent transmissions do not necessarily result in packet loss, the opportunities of successful concurrent transmissions need to be identified, and the concurrent transmissions can thereafter be scheduled accordingly.

TABLE 5.1: Concurrency Principle.

| Case | Description | CT |
|------|---|----|
| 1111 | Collision Free transmission | 1 |
| 1000 | Only DATA concurrency | 0 |
| 1110 | No concurrency of ACK1 and ACK2 | 1 |
| 1011 | No concurrency of DATA2 and ACK1 | 1 |
| 1101 | No concurrency of DATA1 and ACK2 | 1 |
| 1001 | Exposed terminals | 1 |
| 1100 | No concurrency of DATA1 and ACK2, ACK1 and ACK2 | 1 |
| 1010 | No concurrency of DATA2 and ACK1, ACK1 and ACK2 | 1 |
| 0100 | Symbiotic coding[89] | 0 |
| 0110 | Symbiotic coding | 0 |
| 0010 | Symbiotic coding | 0 |
| else | No concurrent transmissions | 0 |

The targeted scenario is an infrastructure WLAN network with multiple APs, where every node can hear each other. Two criteria must be satisfied to allow a new transmission link despite the existing traffic on the channel: the ongoing transmissions should not be disrupted by the new one, and the new transmission should succeed as well. These criteria are calculated at the new transmitting AP based on the position information of relevant nodes and current traffic information. The position information of each client can be obtained through cooperative carrier sensing from the multiple antennas at its associated AP and then shared among the APs through wired transmission; while the

traffic information is obtained from multiple-packet reception from the channel at each AP.

Taking double-link concurrency (two APs sharing the same channel) as an example, with traditional carrier sensing, the second transmission will never be allowed before the first one is finished since the nodes are within each other's transmission range. However, with the proposed concurrency scheme, concurrent transmissions can be enabled in seven of the sixteen cases in Table 5.1, indicated by '1' in the CT field. More detailed explanation of Table 5.1 can be found in Paper G.

After identifying potential opportunities for concurrent transmissions, the new transmission needs to be scheduled to avoid detrimental collisions (indicated as '0's), as shown in the Description field in Table 5.1. Taking the third case (Case 1110) in Table 5.1 as an example, according to the calculation, the concurrent transmissions of two DATA packets and of mixed combined DATA and ACK packets from both senders will not cause packet reception failure and thus should be allowed. However, two concurrent ACK transmissions can be corrupted by the interference from each other and hence should be prohibited. Therefore, the second transmission is scheduled to avoid ACK concurrency, which means that ACK2 has to finish before ACK1 or start after ACK1, as shown in Fig. 5.4.

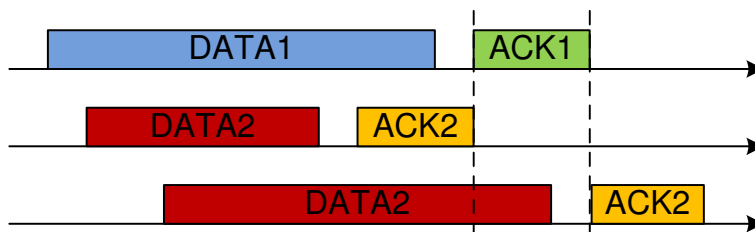

FIGURE 5.4: Concurrency Scheduling of the Secondary Transmission in Case 1110: ACK2 Finishes Transmission before ACK1 or Starts after ACK1.

5.5 C^2SMA/CA : Multi-link Concurrency Scheme

In a dense WLAN network with several APs sharing the same channel, the double-link concurrency scheme introduced in the previous section is not sufficient. Even in a network where different channels can be assigned to different APs, it is still unavoidable in many cases to have multiple APs sharing the same channel due to the high density of APs and limited number of available channels (e.g., three non-overlapping channels in

802.11b/g). Therefore, the C^2SMA/CA scheme should be extended to enable multiple link concurrent transmissions.

In multi-link C^2SMA/CA , the concurrency decision and traffic scheduling is performed at the APs. All APs in the network listen to the channel and keep track of ongoing transmissions. Each AP divides time into blocks of variable lengths so that the overall traffic from all the links on the channel during each block stays the same. A clear illustration of this division procedure is shown in Paper G. The concurrency conditions of the new DATA and ACK packets are calculated separately for each time block, following the same principle as presented in the previous section.

After determining whether or not the new DATA or ACK transmission is supported in every time block, an appropriate time interval is identified and allocated to the new traffic, if there is any. If a qualified time interval for the new transmission is identified, the concurrency scheme will arrange new transmissions accordingly. Otherwise, the transmission follows the same contention procedure as specified in the legacy CSMA/CA mechanism. The concurrency decision making and traffic scheduling procedure needs to be performed again each time when the traffic pattern on the channel changes.

The simulation results in Paper G have shown clearly the advantage of C^2SMA/CA over the traditional scheme. Better performance is achieved with more concurrent links. In a dense network with 20 APs in an area of $50\text{ m} \times 50\text{ m}$, three times higher throughput is provided by C^2SMA/CA compared with traditional CSMA/CA. The average throughput of C^2SMA/CA decreases slowly as the ratio of downlink traffic decreases, because concurrent transmissions can only be initiated at APs where the necessary position and traffic information is available. However, the benefits of concurrent transmissions are still significant even with an equal ratio of uplink/downlink traffic in the network.

CONCLUSIONS AND FUTURE WORK

This final chapter first summarizes the scientific contributions of the dissertation, and then discusses the limitation of the work. A few suggestions for future research are presented in the end.

6.1 Contributions

The main contributions of this PhD work can be summarized as follows:

Comprehensive Cooperative MAC Design for CSMA/CA based Networks. Targeted at one-hop transmission in CSMA/CA based wireless networks, the proposed scheme answers three key questions regarding cooperative communications from the MAC design perspective, namely, when to cooperate, whom to cooperate with, and how to protect cooperative transmissions.

Optimization of the Relay Selection Scheme. A complete analysis of the cooperative protocol performance with impairment caused by collision, is given. Based on that, relay selection optimization is proposed to maximize system performance by reducing the collision probability. The proposed optimal backoff time allocation scheme applies to a group of protocols with similar features.

Formal Verification of the Cooperative Protocol. The integrity and the validity of the C-ARQ protocol are validated using formal methods. The protocol logic is modeled in SDL and implemented in PROMELA. The applicability of formal model

checking to verify the functionality of the cooperative MAC protocol using SPIN is demonstrated.

Performance Comparison of Different Cooperative Schemes. Two different categories of cooperative MAC schemes are evaluated and compared with each other in terms of PDR, throughput and energy efficiency. Based on that, the best transmission scheme can be determined according to different network requirements.

Cooperative Routing Scheme. A novel solution for cooperative routing in a multi-hop ad hoc network through cooperative metrics is proposed. To perform cooperative routing, new metrics need to be calculated for each link for each potential relay and each available cooperative transmission scheme. By comparing these metric values and using the optimal one as the cooperative link metric, the optimal MAC scheme with the optimal relay node is selected for each link. Then, the optimal path from source to destination is established with routing algorithms using the cooperative link metrics.

Cooperation Scheme with Multiple Simultaneous Relays. The two important tasks in cooperation with multiple simultaneous transmitting relays, i.e., distributed relay selection and code allocation schemes, are solved in our proposal by assigning different backoff time to each relay based on their instantaneous relay channel conditions.

Concurrent Transmission Solution. A concurrency transmission scheme is proposed using the position information supplied from cooperative carrier sensing. Multiple transmissions can take place concurrently if the concurrency conditions are satisfied. The multiple concurrent transmissions are scheduled according to channel conditions, while the compatibility with traditional transmissions is kept.

6.2 Limitations of the Research

There are certainly some limitations of our research work. First of all, most of the cooperative schemes proposed in this dissertation (protocols in Papers A, F and G) are targeted at typical WLANs where the involved nodes are one-hop away from each other. We have assumed that all nodes in the network can hear each other and short control packets such as ACK and CFC are always decoded correctly. However, there are problems like hidden terminals that may cause corruptions of these control packets in real

life. Those problems are inherited from traditional networking, and cooperative communications have no obvious contributions to solve them. For simplicity considerations, we have not included such problems in our protocol design and performance evaluation.

Secondly, several fundamental assumptions are made during design and performance analyses. For instance, perfect channel information is assumed for relay selection (Papers A, B, C, F), adaptive MCS (Papers D, E) and concurrency condition calculation (Paper G); perfect synchronization is assumed among relays during the relay selection or declaration (Papers A, B, C, E); and perfect position estimation is assumed in cooperative carrier sensing (Paper G). All these assumptions typically require special hardware support (e.g., accurate sensing) or sophisticated signal processing algorithms (e.g., channel equalizing). Therefore, the performance of cooperative systems in reality can be affected by system impairments and realistic network scenarios.

Finally, in this study, the cooperative system performance evaluations are carried out by implementing the proposed schemes in their corresponding network scenarios in MATLAB. The results are mostly sufficient to indicate the advantages of the proposed schemes. However, a lot of new problems are expected when it comes to deploying these protocols in real life. Of high importance is the quantification of the effects of real world impairments on the performance of cooperative systems. The primary concerns are the impact of channel estimation errors, synchronization errors, phase errors, erroneous feedback information, etc. The performance evaluation of the cooperative schemes will be more convincing if a prototype is implemented and tested in real network scenarios.

6.3 Suggestions for Future Research

The issues raised in the previous section can trigger future studies in this field. The benefits of cooperative communications can only be fully verified by joint investigation of the techniques and challenges from the physical layer, the MAC layer and the network layer. The impact of many potential problems from each layer on the design and performance of a complete cooperative system has not been well understood yet. Prototype implementations are very much encouraged to be developed for evaluating any proposed cooperative system.

Meanwhile, the research work in this dissertation opens up several potential topics for future study. A few examples are given in the following.

- The resource allocation and optimization issue is a significant topic to study considering different network scenarios and performance requirements.
- The optimization solution of the relay selection scheme with multiple simultaneous transmitting relays in Paper F should be further investigated.
- With regard to cooperative networking, a straightforward solution was used to combine cooperative MAC and routing, while there exist many various possibilities. In fact, very little attention has been paid to higher layer issues of cooperative communications, e.g., cooperative routing, traffic scheduling and flow control.
- In the transmission concurrency topic, the impact of inaccurate position estimations as well as of imperfect channel estimation needs to be investigated. It would also be interesting to study the additional benefits of beamforming to increase the probability of transmission concurrency.

Last but not least, it is difficult to design a general-purpose cooperative communication system that applies to all network scenarios. There are plenty of typical scenarios in wireless networks that are suitable for cooperative communications. One of the most important goals is to design cooperative schemes which are compatible with the existing techniques in the market. It is worthwhile to mention that cooperative communications should be viewed as an alternative to improve network performance, parallel to other techniques such as adaptive MCS, packet length adaptation and so on. The benefits from cooperative communications should be evaluated in very specific network scenarios and in joint consideration with other approaches. For example, with all the advanced physical layer techniques available in WLANs, the extra benefits of cooperative communications are negligible under good channel conditions. However, significant advantages can be achieved when cooperative transmissions are applied in other network scenarios, e.g., the lifetime of wireless sensor networks can be extended dramatically with appropriate cooperating schemes to reduce the forwarding traffic loads of energy-depleting nodes.

All in all, it is important to identify network scenarios where cooperative communications could be used, and cooperative schemes should be designed for specific types of networks in order to maximize the benefits.

REFERENCES

- [1] A. Goldsmith, *Wireless Communications*, Cambridge University Press, ISBN 10: 0521837162 / 0-521-83716-2 , ISBN 13: 9780521837163, 2005.
- [2] M. Dohler and Y. Li, *Cooperative Communications: Hardware, Channel and PHY*, John Wiley & Sons, Inc., ISBN: 978-0-470-99768-0, 2010.
- [3] F. Peyrard, T. Val, and J. J. Mercier, "Simulations of ad-hoc WLAN with or without relay", *Proceedings of IEEE International Conference on Universal Personal Communications (ICUPC)*, Vol. 1, pp. 711-715, Oct. 1998.
- [4] N. Esseling, E. Weiss, A. Kramling, and W. Zirwas, "A multi hop concept for Hiper-LAN/2: Capacity and interference", *European Wireless 2002*, Vol. 1, pp. 1-7, Feb. 2002.
- [5] C. Casetti, C. F. Chiasserini, and L. Previtiera, "Fair relaying and cooperation in multi-rate 802.11 networks", *Proceedings of IEEE Vehicular Technology Conference (VTC)*, Vol. 3, pp. 2033-2036, May/June 2005.
- [6] A. So and B. Liang, "Exploiting spatial diversity in rate adaptive WLANs with relay infrastructure", *al Proceedings of IEEE Global Telecommunications Conference (GLOBECOM)*, Vol. 5, Nov./Dec. 2005.
- [7] A. So and B. Liang, "Effect of relaying on capacity improvement in wireless local area networks", *Proceedings of IEEE Wireless Communications and Networking Conference (WCNC)*, Vol. 3, pp. 1539-1544, Mar. 2005.
- [8] K. N. Ting, Y. F. Ko, and M. L. Sim, "Voice performance study on single radio multihop IEEE 802.11b systems with chain topology", *Proceedings of IEEE 13th International Conference on Networks*, Vol. 1, Nov. 2005.
- [9] M. Kuhn, A. Etefagh, I. Hammerstrom, and A. Wittneben, "Two-way communication for IEEE 802.11n WLANs using decode and forward relays", *Proceedings of Fortieth Asilomar Conference on Signals, Systems and Computers (ACSSC)*, pp. 681-685, Oct./Nov. 2006.

- [10] A. Etefagh, M. Kuhn, I. Hammerstrom, and A. Wittneben, "On the range performance of decode-and-forward relays in IEEE 802.11 WLANs", *Proceedings of IEEE 17th International Symposium on Personal, Indoor and Mobile Radio Communications(PIMRC)*, pp. 1-5, Sept. 2006.
- [11] L. Guo, X. Ding, H. Wang, Q. Li, S. Chen, and X. Zhang, "Cooperative relay service in a wireless LAN", *IEEE Journal on Selected Areas in Communications (JSAC)*, Vol. 25, pp. 355-368, Feb. 2007.
- [12] M. H. Lu, P. Steenkiste, and T. Chen, "Time-aware opportunistic relay for video streaming over WLANs", *Proceedings of IEEE International Conference on Multimedia and Expo*, pp. 1782-1785, July 2007.
- [13] A. So and B. Liang, "Enhancing WLAN capacity by strategic placement of tetherless relay points", *IEEE Transactions on Mobile Computing*, Vol. 6, pp. 474-487, May 2007.
- [14] D. Niyato and E. Hossain, "Integration of IEEE 802.11 WLANs with IEEE 802.16-based multihop infrastructure mesh/relay networks: a game-theoretic approach to radio resource management", *IEEE Network*, Vol. 21, pp. 6-14, May/June 2007.
- [15] M. Dohler, D. E. Meddour, S. M. Senouci, and A. Saadani, "Cooperation in 4G - hype or ripe?", *IEEE Technology and Society Magazine*, Vol. 27, No. 1, pp. 13-17, Mar. 2008.
- [16] R. Pabst, B. H. Walke, D. C. Schultz, P. Herhold, H. Yanikomeroglu, S. Mukherjee, et al., "Relay-based deployment concepts for wireless and mobile broadband radio", *IEEE Communications Magazine*, Vol. 42, pp. 80-89, Sept. 2004.
- [17] 3rd Generation Partnership Project (3GPP), "Technical specification group radio access network; opportunity driven multiple access", *3G TR 25.924*, V1.0.0, 1999.
- [18] T. Rouse, S. McLaughlin, and H. Haas, "Coverage-capacity analysis of opportunity driven multiple access (ODMA) in UTRA TDD", *Proceedings of the Second International Conference on 3G Mobile Communication Technologies*, No. 477, pp. 252-256, Mar. 2001.
- [19] T. Rouse, I. Band, and S. McLaughlin, "Capacity and power investigation of opportunity driven multiple access (ODMA) networks in TDD-CDMA based systems",

- Proceedings of IEEE International Conference on Communications (ICC)*, Vol. 5, pp. 3202-3206, Apr. /May 2002.
- [20] M. Ouertani, H. Besbes, and A. Bouallegue, "A new design approach for ODMA systems", *Proceedings of the First International Symposium on Control, Communications and Signal Processing*, pp. 343-346, Sept. 2004.
- [21] T. Rouse, S. McLaughlin, and I. Band, "Congestion-based routing strategies in multihop TDD-CDMA networks", *IEEE Journal on Selected Areas in Communications (JSAC)*, Vol. 23, No. 3, pp. 668-681, Mar. 2005.
- [22] R. G. Cheng, S. M. Cheng, and P. Lin, "Power-efficient routing (PER) mechanism for ODMA systems", *Proceedings of the International Conference on Wireless Networks, Communications and Mobile Computing (IWCMC)*, Vol. 1, pp. 129-134, June, 2005.
- [23] R. G. Cheng, S. M. Cheng, and P. Lin, "Power-efficient routing mechanism for ODMA systems", *IEEE Transactions on Vehicular Technology*, Vol. 55, pp. 1311-1319, July 2006.
- [24] A. Gkelias, M. Dohler, and H. Aghvami, "HIPERLAN/2 for vehicle-to-vehicle communication", *Proceedings of IEEE 13th International Symposium on Personal, Indoor and Mobile Radio Communications (PIMRC)*, Vol. 3, pp. 1058-1062, Sept. 2002.
- [25] M. L. Sichitiu and M. Kihl, "Inter-vehicle communication systems: a survey", *IEEE Communications Surveys & Tutorials*, Vol. 10, pp. 88-105, July 2008.
- [26] Y. Sun, O. Gurewitz, and D. B. Johnson, "RI-MAC: a receiver initiated asynchronous duty cycle MAC protocol for dynamic traffic loads in wireless sensor networks", *Proceedings of ACM Conference on Embedded Networked Sensor Systems (SenSys)*, pp. 1-14, Nov. 2008.
- [27] J. W. Jung and M. A. Ingram, "Residual-Energy-Activated Cooperative Transmission (REACT) to avoid the energy hole", *Proceedings of IEEE International Conference on Communications (ICC) Workshops on Cooperative and Cognitive Mobile Networks (CoCoNet3)*, pp. 1-5, May 2010.

- [28] B. Timus, "Studies on the viability of cellular multihop networks with fixed relays", *PhD Dissertation*, Kungliga Tekniska högskolan (KTH), Stockholm, Sweden, May 2009.
- [29] J. N. Laneman, D. N. C. Tse, and G. W. Wornell, "An efficient protocol for realizing cooperative diversity in wireless networks", *Proceedings of IEEE International Symposium on Information Theory (ISIT)*, Vol. 1, pp. 294, Aug. 2001.
- [30] T. M. Cover and A. A. E. Gamal, "Capacity theorems for the relay channel", *IEEE Transactions on Information Theory*, Vol. 25, No. 5, pp. 572-584, Jan. 1979.
- [31] T. E. Hunter and A. Nosratinia, "Cooperative diversity through coding", *Proceedings of IEEE International Symposium on Information Theory (ISIT)*, pp. 220, July 2002.
- [32] M. Simon and M. S. Alouini, *Digital Communication over Fading Channels*, John Wiley & Sons, Inc., second edition, 2005.
- [33] G. Bianchi, "Performance analysis of the IEEE 802.11 distributed coordination function", *IEEE Journal on Selected Areas in Communications (JSAC)*, Vol. 18, No. 1, pp. 535-547, Jan. 2000.
- [34] X. J. Dong and P. Varaiya, "Saturation throughput analysis of IEEE 802.11 wireless LANs for a lossy channel", *IEEE Communication Letters*, Vol. 9, No. 2, Feb. 2005.
- [35] X. He, K. Niu, Z. He, and J. Lin, "Link layer abstraction in MIMO-OFDM system", *International Workshop on Cross Layer Design*, pp. 41-44, Sept. 2007.
- [36] J. N. Laneman, D. N. C. Tse, and G. W. Wornell, "Cooperative diversity in wireless networks: efficient protocols and outage behavior", *IEEE Transactions Information Theory*, Vol. 50, No. 12, pp. 3062-3080, Dec. 2004.
- [37] A. Sendonaris, E. Erkip, and B. Aazhang, "User cooperation diversity - Part II: implementation aspects & performance analysis", *IEEE Transactions on Communications*, Vol. 51, No. 11, pp. 1939-1948, Nov. 2003.
- [38] M. Levorato, S. Tomasin, and M. Zorzi, "Cooperative spatial multiplexing for Ad Hoc networks with hybrid ARQ: system design and performance analysis", *IEEE Transactions on Communications*, Vol. 56, No.9, pp. 1545-1555, Sept. 2008.

- [39] A. Azgin, Y. Altunbasak, and G. AlRegib, "Cooperative MAC and routing protocols for wireless ad hoc networks", *Proceedings of IEEE Global Telecommunications Conference (GLOBECOM)*, Vol. 5, pp. 2854-2859, Jan. 2005.
- [40] P. Liu, Z. Tao, S. Narayanan, T. Korakis, and S. Panwar, "CoopMAC: A cooperative MAC for wireless LANs", *IEEE Journal on Selected Areas in Communications (JSAC)*, Vol. 25, pp. 340-354, Feb. 2007.
- [41] J. S. Pathmasuritharam, A. Das, and A. K. Gupta, "Efficient multi-rate relaying (EMR) MAC protocol for ad hoc networks", *Proceedings of IEEE International Conference on Communications (ICC)*, Vol. 5, pp. 2947-2951. Aug. 2005.
- [42] J. Alonso-Zarate, E. Kartsakli, C. Verikoukis, and L. Alonso, "Persistent RC-SMA: a MAC protocol for a distributed cooperative ARQ scheme in wireless networks", *EURASIP Journal on Advances in Signal Processing*, Vol.2008, DOI:10.1155/2008/817401, Apr. 2008.
- [43] IEEE Std., "IEEE 802.11: Wireless LAN Medium Access Control (MAC) and Physical Layer (PHY) Specifications", *IEEE-SA*, DOI: 10.1109/IEEESTD.2007.373646, June 2007.
- [44] H. Shan, P. Wang, W. Zhuang, and Z. Wang, "Cross-layer cooperative triple busy tone multiple access for wireless networks", *Proceedings of IEEE Global Telecommunications Conference (GLOBECOM)*, pp. 1-5, Nov. 2008.
- [45] A. K. Sadek, W. Yu, and K. J. R. Liu, "When does cooperation have better performance in sensor networks?", *Proceedings of IEEE Communications Society Conference on Sensor, Mesh and Ad Hoc Communications and Networks (SECON)*, pp. 188-197, Sept. 2006.
- [46] Y. Zhao, R. Adve, and T. J. Lim, "Improving amplify-and-forward relay networks: optimal power allocation versus selection", *IEEE Transactions on Communications*, Vol. 6, No. 8, pp. 3114-3123, Aug. 2007.
- [47] X. He and F. Y. Li, "An optimal energy efficient cooperative retransmission MAC scheme in Wireless Networks", *Proceedings of Wireless Communication, Vehicular Technology, Information Theory and Aerospace & Electronic Systems Technology (Wireless VITAE)*, Chennai, India, Feb. 2011.

- [48] A. Bletsas, A. Khisti, D. P. Reed, and A. Lippman, "A simple cooperative diversity method based on network path selection", *IEEE Journal on Selected Areas in Communications (JSAC)*, Vol. 24, No. 3, pp. 695-672, Oct. 2006.
- [49] M. G. Jibukumar, R. Datta, and P. K. Biswas, "CoopMACA: a cooperative MAC protocol using packet aggregation", *Wireless Networks*, Springer, DOI: 10.1007/s11276-009-0232-8, Dec. 2009.
- [50] SPIN tool website, "<http://www.spinroot.com>",
- [51] E. M. Clarke, O. Grumberg, D. Peled, *Model Checking*, The MIT Press, ISBN-13: 978-0-262-03270-4, 2000.
- [52] G. J. Holzmann, "The model checker SPIN", *IEEE Transactions on Software Engineering*, Vol. 23, No. 5, pp. 279-295, May 1997.
- [53] G. J. Holzmann, "An analysis of bitstate hashing", *Formal Methods in System Design*, Vol. 13, No. 3, pp. 289-307, Nov. 1998.
- [54] <http://www.sdl-forum.org/SDL/index.htm>
- [55] X. He and F. Y. Li, "An automatic retransmission cooperative MAC protocol in wireless local area networks", *Proceedings of European Wireless*, Aalborg, Denmark, May 2009.
- [56] B. Gui, L. Dai, and L. J. Cimini, "Routing strategies in multihop cooperative networks", *IEEE Transaction on Wireless Communications*, Vol. 8, No. 2, pp. 843-855, Feb. 2009.
- [57] S. Chen, U. Mitra, and B. Krishnamachari, "Cooperative communication and routing over fading channels in wireless sensor networks", *Proceedings of IEEE International Conference on Wireless Networks, Communications, and Mobile Computing (WirelessCom)*, Vol. 2: 1477-1482, Dec. 2005.
- [58] A. E. Khandani, J. Abounadi, E. Modiano, and L. Zheng, "Cooperative routing in static wireless networks", *IEEE Transactions on Communications*, Vol. 55, No. 11, pp. 2185-2192, Nov. 2007.
- [59] S. Moh, "Two cooperation models and their optimal routing for cooperative diversity in wireless ad hoc networks", *Proceedings of IEEE International Symposium on Wireless Communication Systems (ISWCS)*, pp. 57-61, Oct. 2008.

- [60] K. Vijayasankar, L. N. Kannan, M. Tacca, and A. Fumagalli, "CETT: a cross layer routing metric for cooperative wireless ad hoc networks", *Proceedings of IEEE International Symposium on Modeling, Analysis & Simulation of Computer and Telecommunication Systems (MASCOTS)*, Vol. 1, pp. 1. Sept. 2009.
- [61] W. C. Y. Lee, "Estimate of channel capacity in Rayleigh fading environment", *IEEE Transactions on Vehicular Technology*, Vol. 39, pp. 187-189, Aug. 1990.
- [62] S. Chen, M. A. Beach, and J. P. McGeehan, "Division-free duplex for wireless applications", *Electronics Letters*, Vol. 34, pp. 147-148, Jan. 22, 1998.
- [63] G. Foschini, "Layered space-time architecture for wireless communications in a fading environment when using multi-element antennas", *Bell Labs Technical Journal*, Vol. 1, pp. 41-59, Autumn 1996.
- [64] S. M. Alamouti, "A simple transmit diversity technique for wireless communications", *IEEE Journal on Selected Areas in Communications (JSAC)*, Vol. 16, pp. 1451-1458, Oct. 1998.
- [65] V. Tarokh, H. Jafarkhani, and A. R. Calderbank, "Space-time block codes from orthogonal designs", *IEEE Transactions on Information Theory*, Vol. 45, pp. 1456-1467, July 1999.
- [66] V. Tarokh, N. Seshadri, and A. R. Calderbank, "Space-time codes for high data rate wireless communication: performance criterion and code construction", *IEEE Transactions on Information Theory*, Vol. 44, pp. 744-765, Mar. 1998.
- [67] B. Vucetic and J. Yuan, *Space Time Coding*, John Wiley & Sons, Inc., June 2003.
- [68] J. N. Laneman and G. W. Wornell, "Distributed space-time coded protocols for exploiting cooperative diversity in wireless networks", *IEEE Transactions on Information Theory*, Vol. 50, No. 10, pp. 2415-2425, Oct. 2003.
- [69] J. Laneman, "Cooperative diversity in wireless networks: algorithms and architectures", *PhD Dissertation*, Massachusetts Institute of Technology (MIT), USA, Sept. 2002.
- [70] A. Stefanov and E. Erkip, "On the performance analysis of cooperative space-time coded systems", *Proceedings of IEEE Wireless Communications and Networking (WCNC)*, Vol. 2, pp. 729-734, Mar. 2003.

- [71] A. Stefanov and E. Erkip, "Cooperative space-time coding for wireless networks", *Proceedings of IEEE Information Theory Workshop*, pp. 50-53, Mar./ Apr. 2003.
- [72] B. Mondal and R. W. Heath, "Performance analysis of quantized beamforming MIMO systems", *IEEE Transactions on Signal Processing*, Vol. 54, No. 12, pp. 4753-4766, Dec. 2006.
- [73] A. Paulraj, R. Nabar, and D. Gore, *Introduction to space-time wireless communications*, Cambridge University Press, ISBN: 0521826152, 2003.
- [74] P. Larsson, "Large-scale cooperative relaying network with optimal combining under aggregate relay power constraint", *Proceedings of Future Telecommunications Conference (FTC)*, June. 2003.
- [75] Y. Jing and H. Jafarkhani, "Network beamforming using relays with perfect channel information", *IEEE Transactions on Information Theory*, Vol. 55, No. 6, pp. 2499-2517, June 2009.
- [76] A. Özgür, O. Leveque, and D. Tse, "Hierarchical cooperation achieves linear capacity scaling in ad hoc networks", *Proceedings of IEEE International Conference on Computer Communications (INFOCOM)*, pp. 382-390, May 2007.
- [77] X. Li, M. Chen, and W. Liu, "Application of STBC-encoded cooperative transmissions in wireless sensor networks", *IEEE Signal Processing Letters*, Vol. 12, No. 2, pp. 134-137, Feb. 2005.
- [78] H. Ochiai, P. Mitran, H. V. Poor, and V. Tarokh, "Collaborative beamforming for distributed wireless ad hoc sensor networks", *IEEE Transactions on Signal Processing*, Vol. 53, No. 5, pp. 1456-1467, Nov. 2005.
- [79] K. Xu, W. Yuan, and W. Cheng, "An energy-efficient V-BLAST based cooperative MIMO transmission scheme for wireless sensor networks", *Proceedings of IEEE Wireless Communications and Networking Conference (WCNC)*, pp. 688-693, Mar. 2008.
- [80] P. Karn, "MACA - a new channel access method for packet radio", *Proceedings of the 9th ARRL Computer Networking Conference*, Vol. 140, pp. 134-140, Sept. 1990.

- [81] A. Jayasuriya, S. Perreau, A. Dadej, and S. Gordon. "Hidden vs. exposed terminal problem in ad hoc networks", *Proceedings of the Australian Telecommunication Networks and Applications Conference*, pp.1-8, Dec. 2004.
- [82] G. Judd, "Using physical layer emulation to understand and improve wireless networks", *PhD Dissertation from Carnegie Mellon University*, CMU-CS-06-164, Oct. 2006.
- [83] S. Lakshmanan, K. Sundaresan, M. Khojastepour, and S. Rangarajan, "Practical multi-antenna spatial reuse in WLANs", *Proceedings of the Conference on Broadband Communications*, pp. 1-20, Oct. 2010.
- [84] P. Karn, "Improving spatial reuse in multihop wireless networks - a survey", *IEEE Communications Surveys & Tutorials*, Vol. 11, No. 3, pp. 71-91, Aug. 2009.
- [85] M. Takai, J. Martin, A. Ren, and R. Bagrodia, "Directional virtual carrier sensing for directional antennas in mobile ad hoc networks", *Proceedings of ACM Mobihoc*, pp. 183-193, June 2002.
- [86] K. Mittal and E. Belding. "RTSS/CTSS: mitigation of exposed terminals in static 802.11-based mesh networks", *Proceedings of IEEE WiMesh Workshop*, pp. 3-12, Sept. 2006.
- [87] M. Vutukuru, K. Jamieson, and H. Balakrishnan, "Harnessing exposed terminals in wireless networks", *Proceedings of the 5th Symposium on Networked Systems Design and Implementation*, pp. 59-72, Aug. 2008.
- [88] S. Kim, J. Cha, and J. Ma, "Design and theoretical analysis of throughput enhanced spatial reuse distributed coordination function for IEEE 802.11", *IET Communications*, Vol. 3, No. 12, pp. 1934-1947, Dec. 2009.
- [89] S. Lakshmanan, C. L. Tsao, and R. Sivakumar, "On coding concurrent transmissions in wireless networks", *ACM SIGMOBILE Mobile Computing and Communications Review*, Vol. 14, No. 2, pp. 4-6, April 2010.

PART II

**COOPERATIVE MAC DESIGN IN MULTI-HOP
WIRELESS NETWORKS PART I: WHEN SOURCE
AND DESTINATION ARE WITHIN THE
TRANSMISSION RANGE OF EACH OTHER**

Title: Cooperative MAC Design in Multi-hop Wireless Networks
- Part I: When Source and Destination are within the Trans-
mission Range of Each Other

Authors: **Xin He** and Frank Y. Li

Affiliation: Department of Information and Communication Technology,
University of Agder, N-4898 Grimstad, Norway

Journal: *Wireless Personal Communications, Springer*, Vol. 57, No.
3, pp. 339-350, DOI: 10.1007/s11277-010-0072-y, 2011.

Copyright: ©Springer

Cooperative MAC Design in Multi-hop Wireless Networks - Part I: When Source and Destination are within the Transmission Range of Each Other

Xin He and Frank Y. Li

Dept. of Information and Communication Technology,

University of Agder (UiA)

N-4898 Grimstad, Norway

Email: {xin.he; frank.li}@uia.no

Abstract — Cooperative communication is regarded as a promising technology in future 5G wireless networks to enhance network performance by exploiting time and/or space diversity via distributed terminals. In this paper, we propose a cooperative medium access protocol which addresses three key aspects of cooperative communications from MAC layer perspective, namely, when to cooperate, whom to cooperate with and how to protect ongoing cooperative transmissions. To further improve the protocol performance in dense networks, three techniques are investigated to avoid potential collision among multiple contending relays. Both analysis and simulation results demonstrate that significant improvement in terms of throughput and packet delivery ratio can be achieved by the proposed cooperative protocol.

Keywords—5G; One-hop cooperative MAC; Relay selection; Collision avoidance

I. INTRODUCTION

In future 5G networks, characterized by ubiquitous computing and communication, cooperative communication via distributed wireless devices is foreseen as an eminent feature. The theory of cooperative diversity has been studied in depth, and significant improvement of network performance has been demonstrated in terms of throughput, outage probability, network coverage and energy efficiency [1].

While most existing work on cooperative communications focuses on physical layer issues, more and more attention has recently been paid to cooperative Medium Access Control (MAC) design in distributed wireless networks. From this perspective, three key issues need to be addressed, i.e., when to cooperate, whom to cooperate with and how

to protect cooperative transmissions. Our study aims at cooperative MAC design to deal with the aforementioned issues with a minimum cost of network resources.

Within such a context, a Cooperative Automatic Repeat reQuest protocol (C-ARQ) is proposed in this paper. Firstly, cooperative transmission is initiated only when the direct transmission fails. In this way, unnecessary occupation of channels by relay nodes and waste of system resources are avoided. Secondly, the relay nodes are sorted by different backoff time before data retransmission, and the relay node with best relay channel quality will be selected to forward the data packet first. Lastly, the cooperative transmission sequences are specifically designed to give cooperative retransmissions higher priority for channel access and to protect ongoing packet forwarding by relay nodes. Furthermore, to avoid collisions among multiple contending relay nodes for packet retransmission in a dense network, we introduce three enhanced techniques based on C-ARQ, referred to as *the p-persistent access scheme*, *the increased threshold scheme* and *the extended backoff scheme*. Both analytical and simulation studies are conducted to evaluate the performance of the proposed schemes, in terms of network throughput and packet delivery ratio.

The rest of the paper is organized as follows. The related work is briefly summarized in Sec. II before the system model is described in Sec. III. After that, the proposed protocol is explained in details in Sec. IV. Throughput and packet delivery ratio analysis of different protocols is given in Sec. V., and the performance is evaluated through simulations in Sec. VI. Finally, the paper is concluded in Sec. VII.

II. RELATED WORK ON COOPERATIVE NETWORKING

Most cooperative schemes in the literature have traditionally focused on physical layer issues based on a three-node scenario [2]. However, little attention has been paid to cooperative networking, and cooperative MAC design remains to large extent an unchartered area. For instance, the assumption of simultaneous transmission of source and relay in many publications [3] -[5] needs to be re-visited. In the following, we classify existing cooperative MAC mechanisms into two categories.

A. Distributed On-demand Cooperative ARQ

The concept of distributed cooperative ARQ have been proposed and studied in a few recent publications. We refer to this type of cooperation as *on-demand cooperative ARQ*

since it is activated only if the initial source-to-destination transmission fails. The gain of a cooperative ARQ scheme in terms of transmission reliability is derived in [6].

Persistent Relay Carrier Sensing Multiple Access (PRCSMA) [7] is claimed to be the first cooperative ARQ MAC, in which all relay nodes contend for channel access according to the Distributed Coordination Function (DCF) protocol if the direct transmission is not successful. However, the resulted long defer time and random backoff interval at each relay lead to its low bandwidth efficiency.

B. Proactive Multi-rate Cooperative MAC

This group of cooperative MAC protocols deal with the tradeoff on whether one-hop direct transmission at a lower data rate or two-hop communication at a higher data rate should be used to achieve maximal end-to-end throughput. These MAC protocols are operated in a *proactive* manner, since which alternative to use is pre-decided before each packet transmission.

The most representative proactive multi-rate cooperative protocol is CoopMAC [8]. In CoopMAC, a helper is selected from a CoopTable which is established and maintained based on the observations of historical transmissions. Similar to [8], Efficient Multi-rate Relaying (EMR) MAC [9] is another example of MAC design which deals with the multi-rate issues in ad hoc networks. In EMR MAC, a relay link is selected if it can provide higher effective throughput. The effective throughput is obtained based on an assumption of ideal physical channel condition in both the direct source-destination link and the combined source-relay-destination link.

Another important aspect in cooperative MAC design is relay selection. There exist many approaches for relay selection. Some of them are based on the geographic locations of the nodes, provided that such information is available through hardware support. Other schemes introduce additional signaling to select relays and to synchronize data transmission. Recently, a simple distributed method has been proposed in [10] to select the best path without any topology information or any explicit communications among relay nodes.

To summarize our discussions on related work, although more attention has recently been drawn to cooperative MAC design, further efforts are still needed for solutions of the three key issues we mentioned above, especially when the compatibility with CSMA

with Collision Avoidance (CSMA/CA) is taken into consideration. In what follows, we present our C-ARQ protocol, as an effort towards this direction.

III. SYSTEM MODEL AND ASSUMPTIONS

The network shown in Fig. F.1 is taken as an example to illustrate the network topology and cooperation scenario. The network consists of a source node, S, a destination node, D, and several randomly distributed potential relay nodes, R_1, R_2, \dots, R_n .

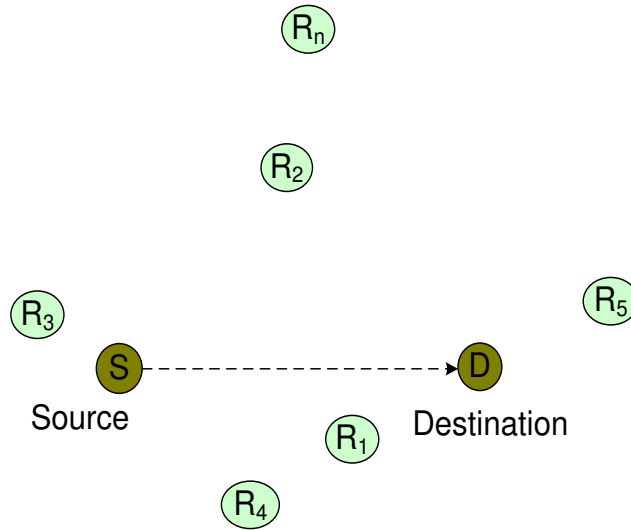

FIGURE A.1: System Model for Cooperative Transmission.

In this model, S and D are within the transmission range of each other. The channels between every transmission pair, i.e., between S and D, S and each relay node R_i , as well as R_i and D, are assumed to be independent of each other, hence full spatial diversity can be achieved by data retransmission over another/other channel(s). Moreover, we assume that consecutive packets on the same channel are subjected to the same channel fading condition and hence identical packet error rate.

IV. COOPERATIVE MAC PROTOCOL DESIGN: C-ARQ

In this section, we first present the relay selection scheme proposed in C-ARQ, and then how the C-ARQ protocol works is illustrated. Lastly, three techniques to further avoid collisions among relay transmissions are introduced.

A. Relay Selection Criterion

Similar to our previous work in [11], the relay nodes in C-ARQ are selected in a distributed manner by using the instantaneous channel condition obtained through a Call For Cooperation (CFC) packet sent from D. After the cooperative phase starts, each relay candidate starts its timer with an initial value of:

$$T_i = \left\lfloor \frac{SNR_{low}}{SNR_i} \frac{T_{up}}{slottime} \right\rfloor, \quad i = 1, 2, \dots, n \quad (1)$$

where T_i is the backoff time at relay node R_i , defined as an integer in number of microseconds; SNR_i is the SNR value in dB of the CFC packet received at R_i ; SNR_{low} is the threshold of SNR_i for R_i to participate in cooperative retransmission; and n is the number of the relay nodes in the network. The value of SNR_{low} can be determined according to the specified Modulation and Coding Schemes (MCSs) at the physical layer. T_{up} in Eq. (1) is the upper bound of the backoff time for relay candidates. T_{up} in the basic C-ARQ scheme is set to be $DIFS - SIFS$ in order to guarantee that the cooperative retransmission will not be interrupted by other nodes in the network. Different from [11], the granularity of T_i is specified to be $slottime$ of the system in order to cover the propagation delay in the network.

B. Cooperative Automatic Repeat Request Scheme

The message exchange sequence of the C-ARQ scheme is illustrated in Fig. A.2. It has four operation cases: I) direct transmission succeeds; II) best-relay-channel retransmission succeeds; III) multi-relay retransmission succeeds; and IV) the whole cooperative retransmission fails. The C-ARQ protocol procedure is briefly presented in the following. More details about how the cooperative protocol works can be found in [11].

(a) As the first step, S sends out a data packet to its destination D following the original DCF basic access scheme. (b) If and only if the data packet is received erroneously at D, D will broadcast a CFC packet to invite other nodes in the network to operate as relay nodes and at the same time to provide them the opportunity of measuring their respective relay channel quality. According to Eq. (1), the relay node with the best relay channel quality R_b , will first get channel access and forward its received packet to the destination. If D decodes the packet correctly after the best-relay-channel retransmission, D will

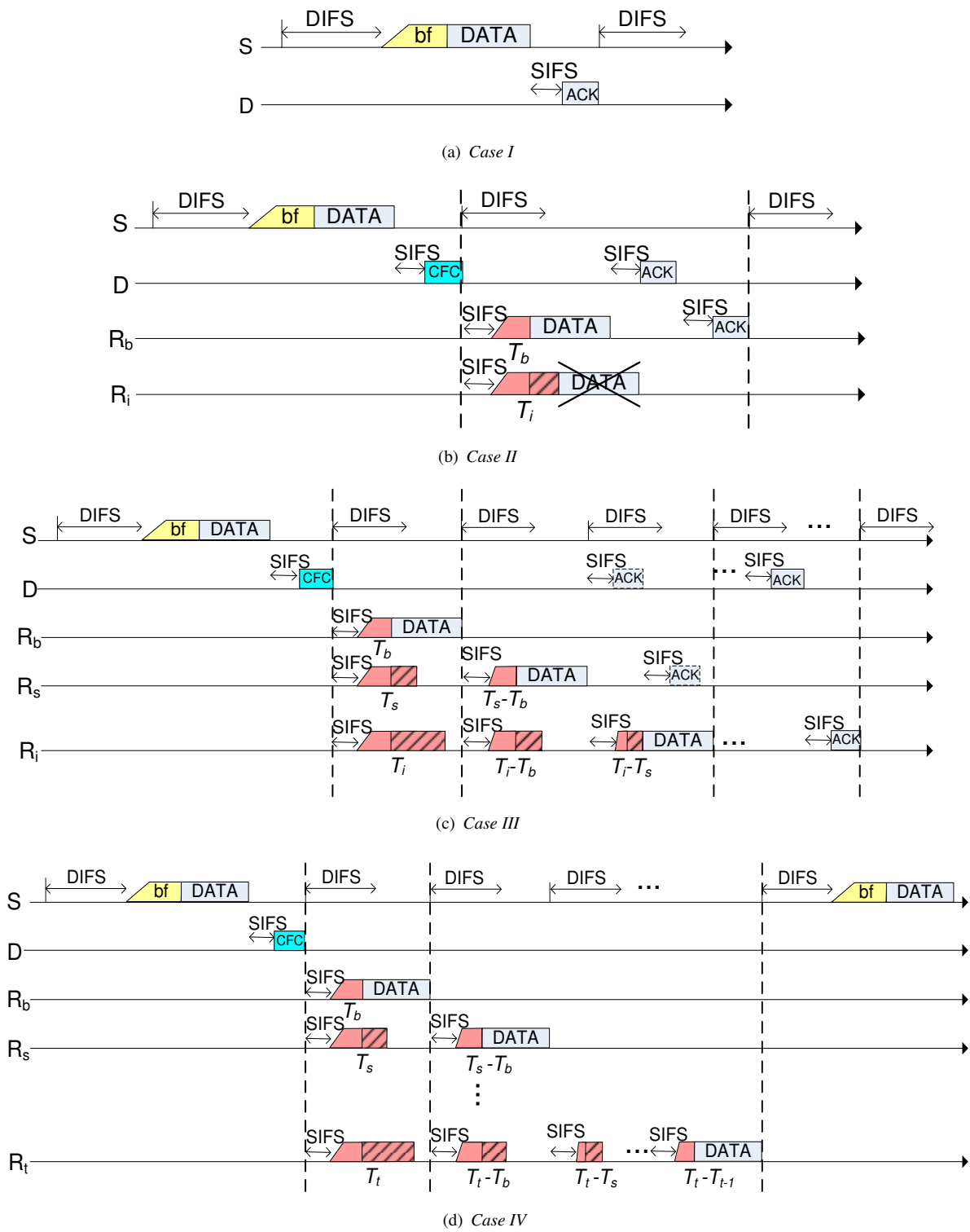

FIGURE A.2: C-ARQ Basic Access Scheme.

return an ACK packet, which is relayed afterwards by R_b to S. (c) Otherwise, the other relay nodes will participate in data retransmission consecutively one after another until D decodes the packet successfully. (d) Finally, if cooperations of all relay nodes still can not lead to successful data reception at D, or if the number of retransmission attempts reaches the retry limit, the cooperative transmission fails.

C. Techniques to Avoid Collision among Relay Transmissions

In Eq. (1), T_{up} is set as $DIFS - SIFS$, which indicates that the scheme can only distinguish at most $\lfloor \frac{DIFS-SIFS}{slottime} \rfloor$ relays, resulting in potential collisions among relays in a dense network. In order to solve this problem, three techniques are proposed:

- *P-persistent Cooperative Automatic Repeat ReQuest (P.C-ARQ).*

With P.C-ARQ, after the timer expires at R, R will forward the packet with a given probability, p , with $0 < p < 1$. It is obvious that the probability of collision can be decreased with a smaller value of p . However, the probability of cooperative retransmissions is also decreased at the same time. Therefore, the parameter p should be tuned properly according to network conditions to maximize overall system performance.

- *Increased Threshold Cooperative Automatic Repeat ReQuest (IT.C-ARQ).*

The SNR threshold of the received signal (SNR_{low}) in Eq. (1) can be adjusted according to IT.C-ARQ. SNR_{low} not only determines whether a relay node is qualified to cooperate but also influences the distribution of the backoff time at all relay candidates and therefore affects collision probability. With a higher SNR_{low} value, the probability of having a qualified relay node for retransmission will decrease accordingly. Meanwhile, fewer relay nodes will be allowed to participate in cooperation, leading to less collision probability. Indeed, the tradeoff needs to be studied with an optimal value of SNR_{low} to maximize throughput performance according to different network conditions.

- *Extended Back-off Cooperative Automatic Repeat ReQuest (EB.C-ARQ).*

Using EB.C-ARQ, the upper bound of the backoff time T_{up} is extended to be $DIFS - SIFS + CW_{min}slottime$. In this way, the relay nodes can be distinguished

and sorted more accurately using this larger range of backoff time. However, the cooperative transmission is only given a higher priority to access the channel by using the minimum contention window CW_{min} in the upper bound, and it is not guaranteed any more that the cooperative retransmission will not be interrupted by other contending nodes in the network.

V. PERFORMANCE ANALYSIS

The performance of the different MAC protocols is analyzed in terms of saturation throughput and Packet Delivery Ratio (PDR) at the MAC layer in this section.

The normalized system saturation throughput, denoted by η , is defined as the successfully transmitted payload bits per time unit. According to [12], η can be calculated as $E[G]/E[D]$, where $E[G]$ is the number of payload information bits successfully transmitted in a virtual time slot, and $E[D]$ is the expected length of the virtual time slot. The virtual time slot here means the time interval between two consecutive packet transmissions initiated by S. The general expressions of $E[G]$ and $E[D]$ for all the three protocols discussed in this paper are given as follows:

$$E[G] = (1 - \prod_{i=1}^m p_{e,i})L. \quad (2)$$

$$E[D] = \begin{cases} E[D_1]; & \text{for } m=1 \\ (1 - p_{e,1})E[D_1] + p_{e,1}E[D_2]; & \text{for } m=2 \\ (1 - p_{e,1})E[D_1] + \sum_{i=2}^{m-1} \prod_{j=1}^{i-1} p_{e,j}(1 - p_{e,i})E[D_i] \\ + \prod_{i=1}^{m-1} p_{e,i}E[D_m]; & \text{for } m \geq 3. \end{cases} \quad (3)$$

In the above expressions, m is the maximal number of possible transmission attempts, including the original direct data frame transmission by the source node; $p_{e,i}$ is the error probability of data packets at the i th transmission attempt; L is the packet length in bits and D_i is the virtual time slot with i performed transmission attempts.

The PDR is the ratio between the number of successfully transmitted packets at the MAC layer and the number of total packets delivered from its upper layer. The general

expression is given as follows:

$$PDR = 1 - \prod_{i=1}^m p_{e,i}. \quad (4)$$

In the following, we take the proposed C-ARQ protocol as an example to illustrate the performance analysis approach. The performance of non-cooperative DCF and PRC-SMA can be calculated in the same way and the analysis results can be found in [11].

With regard to the C-ARQ scheme, m is the minimal value between the retry limit and the number of relay candidates available in the network, plus 1 for the initial direct transmission; $p_{e,1}$ is the packet error rate on the direct channel and $p_{e,i}, i = 2, 3, \dots, m$ is the packet error rate on the $(i - 1)$ th relay channel in the descending order of relay channel quality. $p_{e,i}$ becomes 1 if a collision happens among multiple active relays at the $(i - 1)$ th transmission attempt. In our analysis, it is assumed that the MAC header is always decoded correctly at the destination.

The virtual time slot duration in the case when i transmission attempts are executed in the C-ARQ scheme is denoted as D_i^c and can be expressed as follows:

$$D_i^c = \begin{cases} DIFS + \delta_1 + T_{DATA} + SIFS + T_{ACK}, & \text{if } i=1 \\ DIFS + \delta_1 + (i + 3)SIFS + 2T_{ACK} + iT_{DATA} + T_{CFC} + T_i, & \text{otherwise;} \end{cases} \quad (5)$$

where T_{DATA} and T_{ACK} represent the time used for transmitting the DATA and ACK frames respectively; T_i is the backoff time consumed at the i th retransmitting relay node; and δ_1 is the average backoff time of the first transmission. Since it is assumed that there are no other contending nodes in the network, δ_1 is half of the minimal contention window duration.

The throughput and PDR performance for the C-ARQ scheme can be obtained by substituting the above parameters into Eqs. (2)~(3) and Eq. (4) respectively. The three enhanced versions of the C-ARQ scheme introduced in the preceding section, namely P.C-ARQ, IT.C-ARQ and EB.C-ARQ, can still use the above formulas for the C-ARQ protocol to calculate their throughput and PDR performance. The only difference is that

TABLE A.1: Simulation Parameters.

| | |
|----------------|-----------------------|
| MCS Scheme | QPSK 1/2 / 64 QAM 3/4 |
| Datarate | 12 Mbps / 54 Mbps |
| Basic datarate | 6 Mbps |
| Payload length | 500 bytes |
| CFC | 14 bytes |
| MPDU header | 24 bytes |
| DIFS | 34 μ s |
| PHY header | 20 μ s |
| SIFS | 16 μ s |
| Slottime | 9 μ s |

different schemes result in different backoff time for relay nodes, T_i , and correspondingly different error probabilities at the i th transmission attempt, $p_{e,i}$.

VI. SIMULATIONS AND NUMERICAL RESULTS

To evaluate the performance of the proposed MAC protocol, we have implemented the DCF, PRCSMA and C-ARQ protocols in MATLAB for the purpose of performance comparison. The relay nodes are randomly distributed in a square area of 50 m \times 50 m. The source node and the destination node are placed symmetrically along the center line and 25 meters apart from each other. The path loss coefficient is set to be 4 to emulate the indoor environment. The transmitting and receiving antenna gains are set to be 1. The channels between each transmission pair are implemented as independent Rayleigh fading channels.

For both C-ARQ and PRCSMA, the cooperation SNR threshold is set to be 2.0 dB for QPSK with convolutional code rate 1/2 and 9.0 dB for 64QAM with 3/4 rate respectively. The packet size is set to be 500 bytes. Furthermore, the retry limit is set to be 7 for all the investigated cases. Other simulation parameters are listed in Table A.1.

In the first part of this section, the performance of C-ARQ is evaluated in a sparse network with only 4 or 8 relay nodes in comparison with that of DCF and PRCSMA. In the second part, the performance of the enhanced versions, P.C-ARQ, IT.C-ARQ and EB.C-ARQ, is evaluated in a dense network scenario where collision may become serious. Note that the number of relays listed in all the figures shown below means the number of *potential relays* in the simulated network. The actual number of relays that

participate in each cooperative transmission cycle depends on channel conditions and system parameter configuration.

A. Sparse Relay Network

Fig. A.3 (a) illustrates the throughput comparison of the investigated three protocols under different channel conditions with few potential relays in the network. The simulation results generally coincide with the theoretical analysis, both showing that throughput is enhanced by the cooperative schemes when channel condition is poor (E_t/N_0 in the range of 125~145 dB). Moreover, we can also observe that C-ARQ outperforms PRCSMA generally over all ranges of the investigated channel conditions. In Fig. A.3 (b), both the analytical and simulation results demonstrate that the PDR performance is enhanced significantly by C-ARQ. More significant improvement is observed when the relay nodes are more densely distributed in the network [11].

The average number of collisions among all transmissions for C-ARQ and PRCSMA is illustrated in Fig. A.3 (c). From this figure, one may notice that PRCSMA is to a large degree capable of avoiding collisions among relay nodes thanks to the DCF scheme. In contrast, C-ARQ which uses different backoff time at different contending relay nodes, turns out to be less efficient for collision avoidance. For example, the collision ratio in C-ARQ is 0.08 when there are 4 potential relays, but it increases sharply when the number of potential relays reaches 8. In a denser network with even more contending relays, the collision probability may become noticeably high.

B. Dense Relay Network

To evaluate and compare the performance of the three collision avoidance techniques, we configure a densely distributed network with 50 potential relays nodes and set the data rate to be 12 Mbps. In this way, the collision problem could be observed in more details. The other parameters are configured the same as in the previous subsection.

a. The P.C-ARQ Scheme

Fig. A.4 depicts the performance of P.C-ARQ with different values of p under different channel conditions. It is evident from these figures that parameter p is critical for the performance of P.C-ARQ. When channel condition is poor (E_t/N_0 between 110 dB and 120 dB), there are few qualified relay nodes in the network, a large value of p can

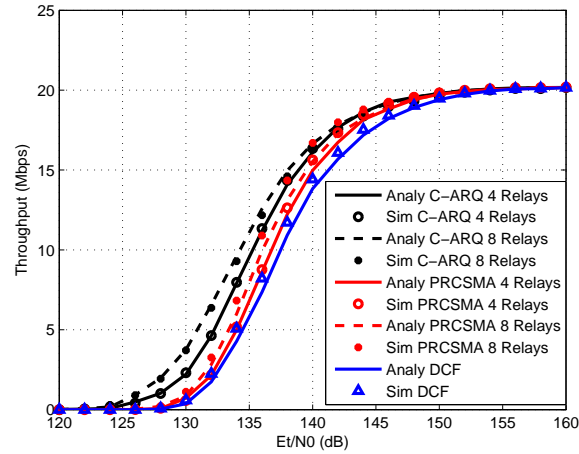

(a) Throughput

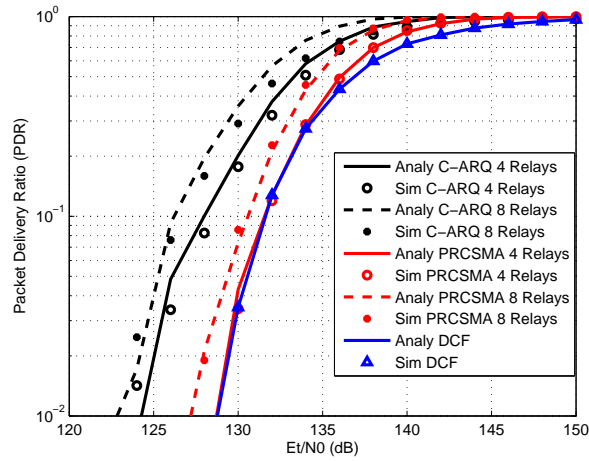

(b) Packet Delivery Ratio

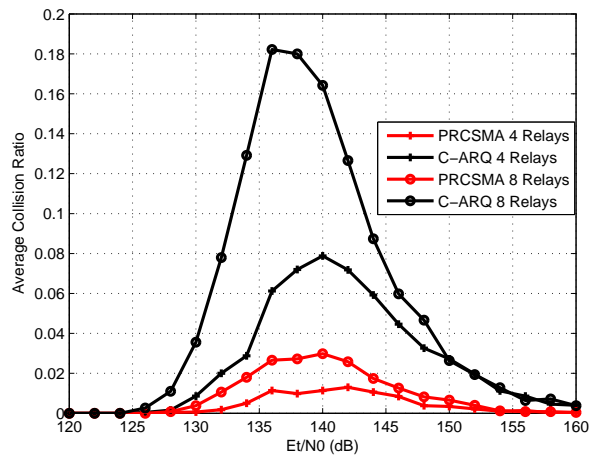

(c) Average Collision Ratio

FIGURE A.3: Performance Comparison in Sparse Networks.

TABLE A.2: Optimal p in P.C-ARQ Scheme.

| E_t/N_0 (dB) | 110 | 115 | 120 | 125 | 130 | 135 | 140 | 145 | 150 |
|--------------------------|------|------|------|------|------|------|------|------|------|
| Optimal p | 0.95 | 1.00 | 0.99 | 0.31 | 0.10 | 0.05 | 0.03 | 0.73 | 0.42 |
| Throughput (Mbps) | 0 | 0.27 | 2.21 | 2.78 | 5.12 | 7.05 | 7.91 | 8.22 | 8.32 |
| PDR | 0 | 0.06 | 0.50 | 0.54 | 0.72 | 0.89 | 0.96 | 0.99 | 1.00 |
| Average Collision Ratio | 0 | 0 | 0.20 | 0.31 | 0.15 | 0.07 | 0.02 | 0.01 | 0 |
| Average Num Cooperations | 0 | 0.07 | 0.78 | 0.87 | 0.45 | 0.17 | 0.05 | 0.02 | 0.01 |

give relay nodes better chance to participate cooperative retransmission. As channel condition becomes better (E_t/N_0 between 120 dB and 130 dB), more relays will contend for channel access, and the throughput impairment by packet collisions becomes more significant, which indicates that a smaller p value will provide better performance. However, p cannot be set to be too small, since it results in too few relay participants, leading to deteriorated throughput and PDR performance. When channels are in very good condition (E_t/N_0 is above 140 dB), cooperative retransmissions rarely happen. Therefore, p has smaller or even negligible influence on throughput performance.

In summary, different values of p should be used to maximize network performance under different channel conditions. The optimal values of p as well as the corresponding performance in terms of throughput, PDR, average collision ratio and average number of retransmissions are listed in Table A.2.

b. The IT.C-ARQ Scheme

Fig. A.5 depicts the performance of IT.C-ARQ with different SNR threshold values for relay selection (SNR_{low}) under different channel conditions. It is shown in both figures that SNR_{low} has significant impact on the performance of C-ARQ, especially where E_t/N_0 is between 115 dB and 140 dB.

As illustrated in Fig. A.5, a determined optimal value of SNR_{low} that maximizes system throughput exists under each specific channel condition. When channel condition is poor and few relay nodes are qualified in the network, SNR_{low} should be small in order to allow more relay nodes to participate in cooperation. However, when there are more contending relays in the network and collisions may happen more often, SNR_{low} should be set to be a higher value to mitigate collision. The obtained optimal values of SNR_{low} and the corresponding performance are summarized in Table A.3.

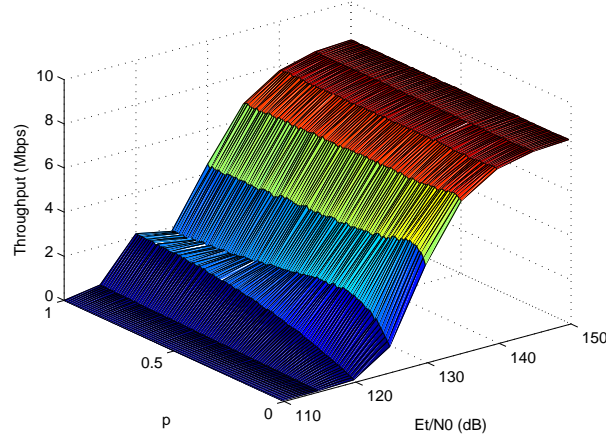

(a) Throughput

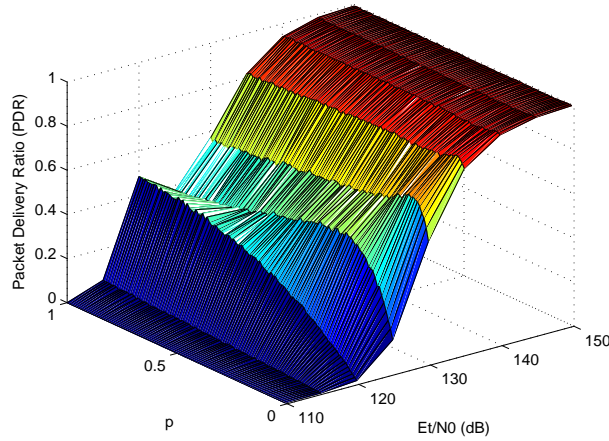

(b) Packet Delivery Ratio

FIGURE A.4: Performance of P.C-ARQ in Dense Networks as a Function of E_t/N_0 and p .TABLE A.3: Optimal SNR_{low} in IT.C-ARQ Scheme.

| E_t/N_0 (dB) | 110 | 115 | 120 | 125 | 130 | 135 | 140 | 145 | 150 |
|--------------------------|------|------|------|------|------|------|------|------|------|
| Optimal SNR_{low} (dB) | 16.4 | 2.7 | 3.5 | 6.7 | 8.1 | 11.0 | 11.7 | 17.4 | 15.1 |
| Throughput(Mbps) | 0 | 0.28 | 2.62 | 4.13 | 6.18 | 7.56 | 8.09 | 8.28 | 8.33 |
| PDR | 0 | 0.06 | 0.59 | 0.89 | 1.00 | 1.00 | 1.00 | 1.00 | 1.00 |
| Average Collision Ratio | 0 | 0 | 0.14 | 0.63 | 0.05 | 0 | 0 | 0 | 0 |
| Average Num Cooperations | 0 | 0.07 | 0.78 | 1.20 | 0.73 | 0.28 | 0.09 | 0.03 | 0.01 |

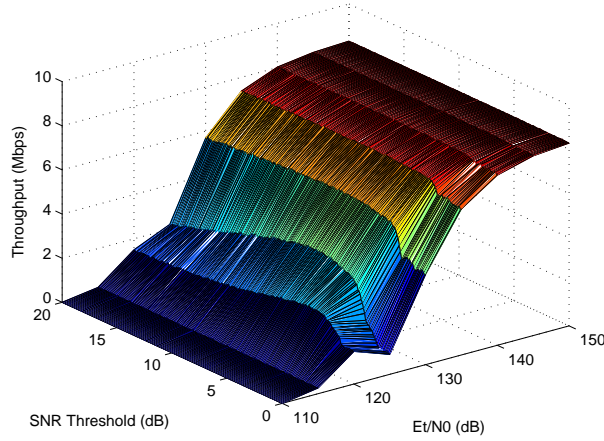
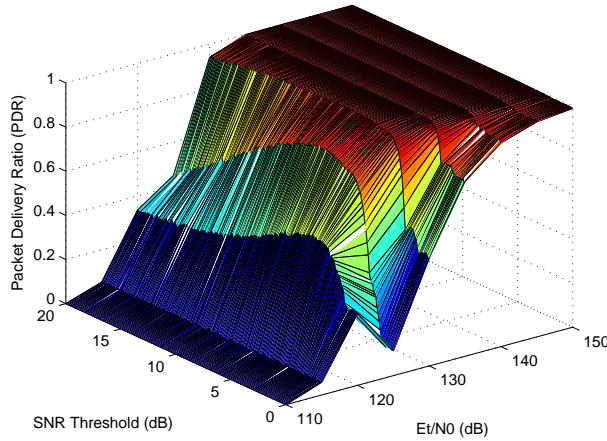
(a) *Throughput*(b) *Packet Delivery Ratio*FIGURE A.5: Performance of IT.C-ARQ in Dense Networks as a Function of E_t/N_0 and SNR Threshold.

c. The EB.C-ARQ Scheme

Finally, we illustrate in Fig. A.6 the performance of EB.C-ARQ in comparison with the optimal P.C-ARQ, optimal IT.C-ARQ, PRCSMA and DCF schemes under diverse channel conditions. The optimal values of p and SNR_{low} have been selected according to Table A.2 and Table A.3 respectively to maximize throughput performance. It can be observed from these two figures that EB.C-ARQ provides best throughput and PDR performance among all these schemes. P.C-ARQ is inferior to PRCSMA when E_t/N_0 is between 125 dB and 140 dB due to its relatively inefficient p-persistent channel access scheme for multiple relays.

The average collision ratios for these schemes are shown in Fig. A.6(c). Again, the EB.C-ARQ scheme appears as the most efficient scheme for collision avoidance. More specifically, in a dense network with 50 potential relays, the peak value of the average collision ratio is still below 0.07 for EB.C-ARQ, which is much lower than 0.24 for PRCSSMA and 0.27 for P.C-ARQ. The high value of collision ratio in P.C-ARQ in Fig. A.6(c) also explains the reason of its inferior throughput and PDR performance.

In addition to the superior throughput and PDR performance over its counterparts, P.C-ARQ and IT.C-ARQ, another advantage of EB.C-ARQ is its simplicity in implementation, since no parameters need to be adjusted even though channel conditions may vary.

VII. CONCLUSIONS

Cooperative communication becomes a characteristic of future 5G wireless networks due to the ubiquity of wireless devices. As a baseline segment in a multi-hop communication chain, we target the scenario of one-hop direct cooperation communication between source and destination in this study. A cooperative MAC protocol, C-ARQ, has been proposed, addressing all the three key issues concerning cooperative communications from the perspective of MAC design. Through analysis and simulations, we demonstrate that C-ARQ generally outperforms the original DCF and PRCSSMA protocols, in terms of both throughput and packet delivery ratio performance. Moreover, P.C-ARQ, IT.C-ARQ and EB.C-ARQ are proposed and studied in depth in order to further avoid collisions in a dense network. EB.C-ARQ outperforms the other two schemes with low implementation complexity as well as low collision rate due to its high accuracy of distinguishing relay nodes.

References

- [1] Laneman, J. N., Tse, D. N. C., & Wornell, G. W. (2004). Cooperative diversity in wireless networks: efficient protocols and outage behavior. *IEEE Trans. Inform. Theory*, 50(12): 3062-3080.

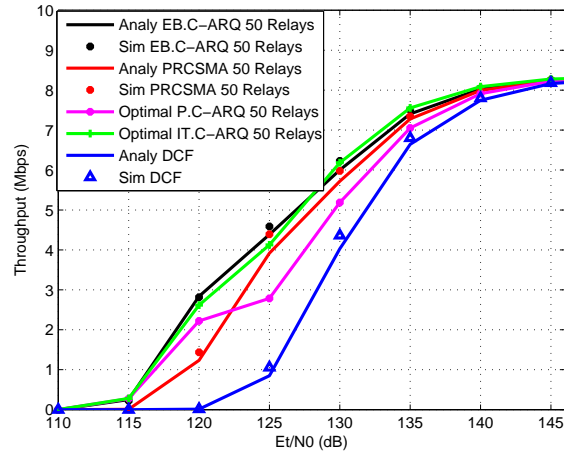

(a) Throughput

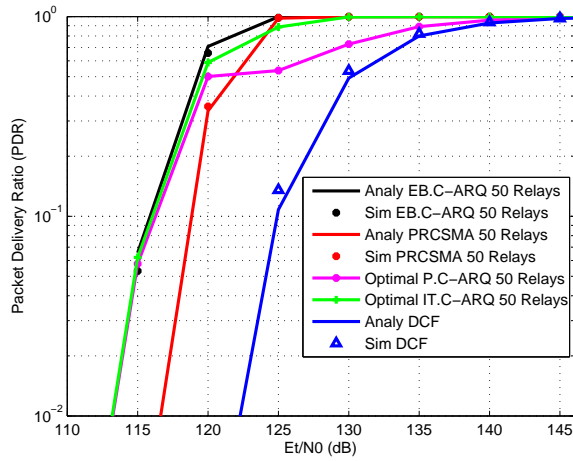

(b) Packet Delivery Ratio

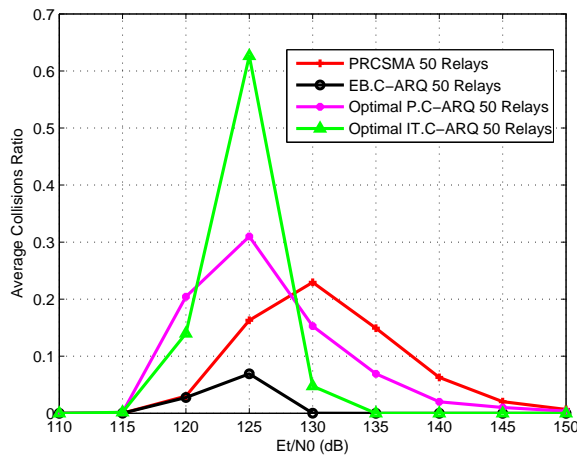

(c) Average Collision Ratio

FIGURE A.6: Performance Comparison in Dense Networks.

- [2] Valentin, S., Lichte, H. S., Karl, H., Vivier, G., Simoens, S., Vidal, J., & Agustin A. (2009). Cooperative wireless networking beyond store-and-forward: Perspectives in PHY and MAC design. *Wireless Personal Communication*, 48: 49-68.
- [3] Levorato, M., Tomasin, S., & Zorzi, M. (2008). Cooperative spatial multiplexing for ad hoc networks with hybrid ARQ: System design and performance analysis. *IEEE Trans. Comm.*, 56(9): 1545-1555.
- [4] Azgin, A., Altunbasak, Y., & AlRegib, G. (2005). Cooperative MAC and routing protocols for wireless ad hoc networks. In *Proceedings of IEEE GLOBECOM*, 5: 2854-2859.
- [5] Moh, S., Yu, C., Park, S., & Kim, H. (2007). CD-MAC: Cooperative diversity MAC for robust communication in wireless ad hoc networks. In *Proceedings of IEEE ICC*, 1: 3636-3641.
- [6] Dianati, M., Ling, X., Naik, K., & Shen, X. (2006). A node-cooperative ARQ scheme for wireless ad hoc networks. *IEEE Trans. Comm.*, 55: 1032-1044.
- [7] Alonso-Zarate, J., Kartsakli, E., Verikoukis, C., & Alonso, L. (2008). Persistent RC-SMA: A MAC protocol for a distributed cooperative ARQ scheme in wireless networks. *EURASIP Journal on Advances in Signal Processing*, 2008: 13.
- [8] Liu, P., Tao, Z., Narayanan, S., Korakis, T., & Panwar, S. (2007). CoopMAC: A cooperative MAC for wireless LANs. *IEEE JSAC*, 25: 340-354.
- [9] Pathmasuritharam, J. S., Das, A., & Gupta, A. K. (2005). Efficient multirate relaying (EMR) MAC protocol for ad hoc networks. In *Proceedings of IEEE ICC*, 5: 2947-2951.
- [10] Bletsas, A., Khisti, A., Reed, D. P., & Lippman, A. (2006). A simple cooperative diversity method based on network path selection. *IEEE JSAC*, 24(3): 695-672.
- [11] He, X., Li, F. Y. (2010). A multi-relay cooperative automatic repeat request protocol in wireless networks, In *Proceedings of IEEE ICC*.
- [12] Bianchi, G. (2000). Performance analysis of the IEEE 802.11 distributed coordination function. *IEEE JSAC*, 18(1): 535-547.

OPTIMIZATION OF THE RELAY SELECTION SCHEME IN COOPERATIVE RETRANSMISSION NETWORKS

Title: Optimization of the Relay Selection Scheme in Cooperative Retransmission Networks

Authors: **Xin He** and Frank Y. Li

Affiliation: Department of Information and Communication Technology, University of Agder, P. O. Box 509, N-4898 Grimstad, Norway

Conference: *IEEE 73rd Vehicular Technology Conference (VTC)*, Budapest, Hungary, May 2011.

Copyright: ©IEEE

Optimization of the Relay Selection Scheme in Cooperative Retransmission Networks

Xin He and Frank Y. Li

Dept. of Information and Communication Technology,

University of Agder (UiA)

N-4898 Grimstad, Norway

Email: {xin.he; frank.li}@uia.no

Abstract — Cooperative MAC protocol design has attracted much attention recently thanks to the development of relaying techniques. In single-relay C-ARQ, the relay selection scheme cannot work efficiently in a dense network, due to high collision probability among different contending relays. In this paper, the throughput performance impairment from the collision is analyzed in a typical network scenario. Thereby, we propose an optimized relay selection scheme aiming at maximizing system throughput by reducing collision probability. The throughput performance enhancement by the proposed optimal relay selection scheme is verified by simulations.

I. INTRODUCTION

Cooperative diversity has been shown to provide significant performance gains in wireless networks where communication may be impeded by channel fading [1]. More and more attention has recently been paid to cooperative Medium Access Control (MAC) design in distributed wireless networks[2]-[4]. Among them, a Cooperative Automatic Repeat reQuest protocol (C-ARQ) has been proposed in [5] in our earlier work to exploit cooperative diversity from the MAC layer.

In single-relay C-ARQ, the best relay node is selected in a distributed manner by relays using different backoff time before packet retransmission. High performance enhancement is achieved by C-ARQ compared with the non-cooperative scheme in a sparse network. However, the advantage can be severely degraded in dense networks because of the high collision probability in the relay selection procedure.

In fact, collision among relays is a common problem that exists in a category of distributed path selection protocols based on different lengths of backoff time [6] before transmission. Collision happens when more than one relay nodes have the same shortest backoff time, and hence transmit simultaneously. For example, the CoopMAC-Aggregation protocol in [7] is proposed for cooperative communication in Wireless Local Area Networks (WLANs). There is a priority round in its helper selection mechanism, where different slots are allotted to different helper groups according to the effective data transmission rate on each relay link. In this case, the collision caused by multiple relay nodes with similar effective data rates and hence the same slottime also leads to serious impairment of the protocol performance in dense networks.

Based on the above discussion, an optimal mapping scheme from relay channel condition to backoff time, is required to reduce collision probability. Therefore, an optimal relay selection scheme, which performs such an optimal mapping, is proposed in this paper to improve the C-ARQ performance in a dense network. Furthermore, the optimal mapping scheme here applies to the above mentioned protocols with similar problems. Hence, the optimization solution study is of great significance. Both analysis and simulations are conducted to evaluate the performance enhancement of the proposed optimal scheme, in terms of network throughput and packet delivery ratio.

The rest of the paper is organized as follows. The system model is described in Sec. II. After that, the cooperative protocol is introduced in III. The optimization problem statement of the relay selection scheme is derived in Sec. IV, and the scheme performance is evaluated through simulations in Sec. V. Finally, the paper is concluded in Sec. VI.

II. SYSTEM MODEL AND ASSUMPTIONS

The network shown in Fig. B.1 is taken as an example to illustrate the network topology and cooperation scenario. The network consists of a source node, S , a destination node, D , and several potential relay nodes, R_1, R_2, \dots, R_n , randomly distributed around D .

This clustered network topology is typical in wireless sensor network scenario [8]. Furthermore, we have demonstrated in [9] that it is more energy efficient to use relay nodes closer to the destination in the cooperative retransmission networks.

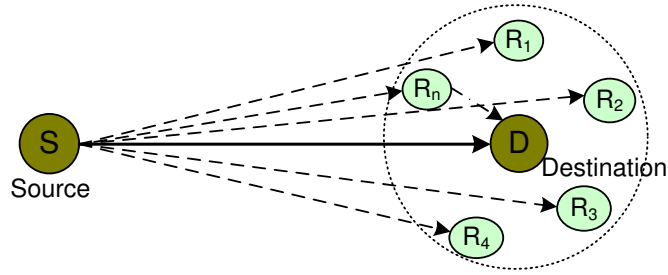

FIGURE B.1: System Model for Cooperative Transmission.

Each direct transmission starts from S, with the intended destination as D. If the direct transmission fails, the relay node which has received the packet successfully and has the best relay channel quality to D will be selected to forward the packet to D, following the cooperative retransmission protocol.

In this model, it is assumed that all nodes can hear each other. The distance between any relay node and D is negligible compared with the distance between S and D. The channels between every transmission pair, i.e., between S and D, S and each relay node R_i , as well as R_i and D, are assumed to be independent of each other, hence full spatial diversity can be achieved by data retransmission over another/other channel(s). Moreover, we assume that the channels are strongly temporally correlated, i.e., consecutive packets on the same channel are subjected to the same channel fading condition and hence identical packet error rate.

III. COOPERATIVE MAC PROTOCOL DESCRIPTION

To exploit cooperative diversity on the MAC layer, three issues need to be addressed: i.e., when to cooperate, whom to cooperate with and how to protect cooperative transmissions. The cooperative C-ARQ protocol is proposed based on the Distributed Coordination Function (DCF) scheme to deal with the above issues in WLANs[5]. In this section, we first summarize the C-ARQ MAC protocol, and then introduce its relay selection algorithm in detail in the second subsection.

A. Cooperative Automatic Repeat Request Scheme

The C-ARQ protocol procedure consists of two phases: direct transmission and cooperative retransmission. The cooperative retransmission only happens when the direct transmission fails.

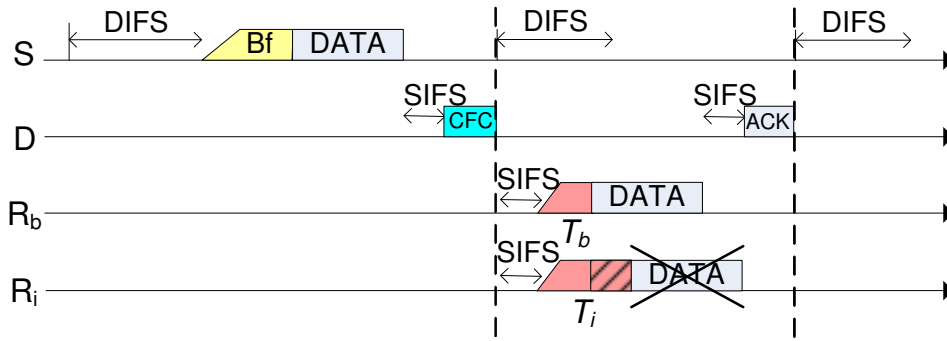

FIGURE B.2: C-ARQ Basic Scheme: Successful Cooperative Retransmission

First, S sends out a DATA packet to its destination D following the original DCF basic access scheme. If and only if the data packet is received erroneously at D, D will broadcast a Call For Cooperation (CFC) packet to invite other nodes in the network to operate as relay nodes and at the same time to provide them the opportunity of measuring their respective relay channel quality. Only relay nodes that have decoded the packet sent by S correctly become relay candidates. According to the relay selection algorithm, the relay candidate with the best relay channel quality R_b , will first get channel access and forward its received packet to the destination. After detecting the data packet from R_b on the channel, the other relay candidates will withdraw from the cooperation contention and discard their received packets. If D decodes the packet correctly after the best-relay-channel retransmission, D will return an ACK packet to S. Otherwise, the cooperative transmission fails. In this case, S will get access to the channel again after a DIFS interval.

The message exchange sequence of the C-ARQ scheme with a successful cooperative retransmission is illustrated in Fig. B.2. More details about the protocol can be found in [5].

B. Relay Selection Scheme

The relay nodes in C-ARQ are selected in a distributed manner by using the instantaneous channel condition obtained through the CFC packet sent from D. After the

cooperative phase starts, each relay candidate gets its backoff time of T_i according to the backoff time function. The mapping from channel condition to backoff time can also be implemented through look-up table. Both methods are explained in the following.

(1) *backoff time function in C-ARQ*

In C-ARQ, the backoff time, T_i is defined as a function:

$$T_i = \left\lfloor \frac{SNR_{low} DIFS - SIFS}{SNR_i slottime} \right\rfloor, \quad i = 1, 2, \dots, n \quad (1)$$

where SNR_i is the Signal-to-Noise Ratio (SNR) value in dB of the CFC packet received at R_i ; SNR_{low} is the threshold of SNR_i for R_i to participate in cooperative retransmission; and n is the number of the relay nodes in the network. The value of SNR_{low} can be determined according to the specified Modulation and Coding Schemes (MCSs) at the physical layer. The upper bound of the backoff time for relay candidates is designed to be (DIFS-SIFS) in order to guarantee that the cooperative retransmission will not be interrupted by other nodes in the network. The granularity of T_i is specified to be *slottime* of the system in order to cover the propagation delay in the network.

(2) *backoff time look-up table for optimization*

The mapping from SNR_i to T_i can also be implemented through Table B.1, where $\vartheta_j, j = 1, 2, \dots, m$ are the threshold values of SNR_i to have different backoff time, and $\vartheta_1 \leq \vartheta_2 \leq \dots \leq \vartheta_m$. ϑ_1 is the threshold value for the relay candidate to cooperate. Each relay candidate gets its backoff time T_i by looking up the above table using its measured SNR value of the CFC packet as index. It is obvious that the relay with highest SNR_i will get the first time slot and hence transmit first.

TABLE B.1: Mapping from SNR to Backoff Time.

| | | | | |
|---------|-------------------------|----------------------------------|---------------------------|------------------------------|
| SNR_i | $[\vartheta_m, \infty)$ | $[\vartheta_{m-1}, \vartheta_m)$ | $[\vartheta_{m-2}, \dots$ | $(\vartheta_1, \vartheta_2)$ |
| T_i | first slot | second slot | ... | $DIFS - SIFS$ |

In Table. B.1, the number of intervals divided among the SNR values, m is determined by the durations of (DIFS-SIFS) and *slottime*. The boundaries involved in this table, $\vartheta_i, i = 1, 2, \dots, m$, can be tuned to maximize the required performance of cooperative retransmission. For instance, in a network with the 802.11g standard, the longest

backoff time is three time slots. Hence, two threshold values, ϑ_1 and ϑ_2 , need to be optimized according to given network scenarios, such as the wireless channel quality and the density of the relay nodes.

IV. OPTIMIZATION PROBLEM STATEMENT

Cooperative MAC Protocol Description The performance of the cooperative retransmission protocol is analyzed in terms of Packet Delivery Rate (PDR) at the MAC layer and system saturation throughput in this subsection.

The PDR of the cooperative scheme is the sum of the packet successful rate in the direct phase and the additional successful probability in the cooperative retransmission phase. Note that in our analysis, no data corruption is assumed on the relay channels from R_i to D due to short distances. Therefore, the failure of cooperative retransmission is only caused by the collision among different relays due to the imperfect relay selection scheme.

$$PDR_c = 1 - \overline{PER}_r + \overline{PER}_r \overline{P_{coop}} (1 - \overline{P_{col}}), \quad (2)$$

where $\overline{P_{coop}}$ and $\overline{P_{col}}$ are the conditional cooperative retransmission probability and collision probability among different relays on the direct transmission failure, respectively.

The normalized system saturation throughput, denoted by η , is defined as the successfully transmitted payload bits per time unit, and can be written as:

$$\eta = \frac{E[\psi]}{E[D]}, \quad (3)$$

where $E[\psi]$ is the number of payload information bits successfully transmitted in a virtual time slot, i.e., the time interval between two consecutive packet transmissions initiated by S in this study; and $E[D]$ is the expected length of the virtual time slot. For our proposed scheme, $E[\psi]$ and $E[D]$ are expressed as follows.

$$E[\psi] = PDR_c L; \quad (4)$$

$$E[D] = (1 - \overline{PER}_r)E[D_1] + \overline{PER}_r(1 - \overline{P}_{coop})E[D_2] + \sum_{j=1}^m \overline{PER}_r \overline{PT}_j E[D_{j+2}]; \quad (5)$$

where L is the payload length in bits; $E[D_1]$ and $E[D_2]$ are the corresponding expected lengths of the virtual time slot when the direct transmission succeeds, and when the direct transmission fails with no cooperative retransmission, respectively; \overline{PT}_j is the probability that the first relay node transmits at the j th time slot, and $E[D_{j+2}]$, $j = 1, 2, \dots, m$ is the expected virtual time slot duration accordingly.

The expected lengths of the virtual time is:

$$E[D_1] = E[\delta] + T_{DATA} + T_{ACK} + SIFS + DIFS; \quad (6)$$

$$E[D_2] = E[D_1] + DIFS; \quad (7)$$

$$E[D_{j+2}] = E[D_1] + T_{DATA} + T_{ACK} + SIFS + j \cdot slottime; \quad (8)$$

where T_{DATA} and T_{ACK} are the transmission time for the DATA and ACK packets, respectively; δ is the consumed backoff time before each packet transmission.

In the following subsections, we will calculate the packet error rate in direct link \overline{PER}_r , the conditional cooperation probability \overline{P}_{coop} , the conditional collision probability \overline{P}_{col} and the distribution of the virtual time slot duration \overline{PT}_j , respectively.

A. Packet Error Rate in Direct Link

For brevity, we assume a Rayleigh fading channel with additive white Gaussian noise (AWGN) on top of path loss, although our analysis can be extended to other fading channels such as Rician or Nakagami.

Since the exact closed-form PER in AWGN channels is difficult to obtain, we rely on the following approximate PER expression from [10] to simplify the analysis:

$$PER_n(\gamma) \approx \begin{cases} 1 & \text{if } \gamma \leq \gamma_n^{th} \\ \beta_n e^{-\kappa_n \gamma}, & \text{if } \gamma > \gamma_n^{th} \end{cases} \quad (9)$$

where n is the MCS index, and γ is SNR at the receiver. Parameters β_n , κ_n and γ_n^{th} are dependent on the specific MCS scheme and data packet length.

Given the average received SNR, $\bar{\gamma}$, the instantaneous received SNR under Rayleigh fading has an exponential distribution as:

$$f(\gamma) = 1/\bar{\gamma} e^{-\gamma/\bar{\gamma}}. \quad (10)$$

Hence, the PER performance at the receiving node averaged over Rayleigh fading is given as:

$$\begin{aligned} \overline{PER}_r(\bar{\gamma}) &= \int_0^{\infty} PER(\gamma) f(\gamma) d\gamma \\ &= \frac{\beta_n}{1 + \kappa_n \bar{\gamma}} e^{-\gamma_n^{th}(\kappa_n + 1/\bar{\gamma})} + \left(1 - e^{-\gamma_n^{th}/\bar{\gamma}}\right). \end{aligned} \quad (11)$$

B. Conditional Cooperation Retransmission Probability

Since all the relays nodes are close to the destination, and the distance between them is negligible compared with the distance from source to destination, we assume the average SNR is the same at all the receiving nodes in the direct transmission phase. Therefore, the average packet error rate, denoted as \overline{PER}_r , is the same at the destination and other relay nodes.

We further assume there are N nodes in the network, and denote the number of nodes that correctly decode the packet as M . Since the channels from the source to different relays are independent, the events that one node successfully receives a packet are independent of each other. Thus, the number of successful nodes is actually subject to a

binomial distribution. The probability that M nodes correctly decode the packet is:

$$P(N, M) = \binom{N}{M} [1 - \overline{PER}_r]^M [\overline{PER}_r]^{N-M}. \quad (12)$$

In the cooperative retransmission phase, the M relay nodes with successful reception of the data packet will first measure the received signal strength of the CFC packet, denoted as $\gamma_i, i = 1, 2, \dots, M$, then contend for channel access using different backoff time T_i according to γ_i . Here, γ_i follows a similar distribution function in Eq. (10), with the average received SNR denoted as $\bar{\gamma}_{rd}$. For convenience, we sort γ_i in the descending order, as $\gamma_1 \geq \gamma_2 \geq \gamma_3 \dots \geq \gamma_M$.

P_{coop} is the probability that there is at least one relay node that will transmit before DIFS-SIFS timeout after an unsuccessful direct transmission. It is equal to the probability of the event that the relay node with the best relay channel quality has higher SNR value than the threshold value, ϑ_1 . Considering the independence of the channels from the source to different relays, P_{coop} can be calculated as:

$$\begin{aligned} P_{coop}(\vartheta_1, M) &= P\{\gamma_1 > \vartheta_1\} = 1 - P\{\gamma_1 \leq \vartheta_1\} \\ &= 1 - P\{\gamma_i \leq \vartheta_1, i = 1, 2, \dots, M\} \\ &= 1 - \prod_{i=1}^M \int_0^{\vartheta_1} 1/\bar{\gamma}_{rd} e^{-\gamma_i/\bar{\gamma}_{rd}} d\gamma_i \\ &= 1 - \left(1 - e^{-\vartheta_1/\bar{\gamma}_{rd}}\right)^M. \end{aligned} \quad (13)$$

Averaging P_{coop} over M leads to:

$$\bar{P}_{coop}(\vartheta_1) = \sum_{M=0}^N P(N, M) P_{coop}(\vartheta_1, M). \quad (14)$$

C. Collision Probability among Different Relays

Collision will happen when the values of γ_1 and γ_2 are close to each other, which leads to two relays sharing the same backoff time. Therefore, the collision probability,

P_{col} , can be written as:

$$P_{col} = \sum_{j=1}^m P \{ \gamma_1, \gamma_2 \in [\vartheta_j, \vartheta_{j+1}) \}, \vartheta_{m+1} = \infty. \quad (15)$$

To calculate the probability of γ_1 and γ_2 lying in the same field $[\vartheta_j, \vartheta_{j+1})$, we have:

$$\begin{aligned} P \{ \gamma_1, \gamma_2 \in [\vartheta_j, \vartheta_{j+1}) \} &= P \{ \gamma_1, \gamma_2 < \vartheta_{j+1} \} - P \{ \gamma_1, \gamma_2 < \vartheta_j \} \\ &\quad - P \{ \vartheta_j \leq \gamma_1 < \vartheta_{j+1}, \gamma_2 < \vartheta_j \}. \end{aligned} \quad (16)$$

In the following, we derive the three items on the right side of Eq. (16) step by step. As defined, γ_1 and γ_2 are the maximal and the second maximal values of the received signal strengths at all the relays, respectively. Hence, $P \{ \gamma_1, \gamma_2 < \vartheta_{j+1} \}$ is equivalent to $P \{ \gamma_1 < \vartheta_{j+1} \}$, and can be obtained as:

$$\begin{aligned} P \{ \gamma_1, \gamma_2 < \vartheta_{j+1} \} &= P \{ \gamma_1 < \vartheta_{j+1} \} \\ &= P \{ \gamma_i < \vartheta_{j+1}, i = 1, 2, \dots, M \} \\ &= \prod_{i=1}^M \int_0^{\vartheta_{j+1}} 1/\bar{\gamma}_{rd} e^{-\gamma_i/\bar{\gamma}_{rd}} d\gamma_i \\ &= \left(1 - e^{-\vartheta_{j+1}/\bar{\gamma}_{rd}} \right)^M. \end{aligned} \quad (17)$$

Similarly, $P \{ \gamma_1, \gamma_2 < \vartheta_j \}$ can be easily obtained.

After that, the third element, $P \{ \vartheta_j \leq \gamma_1 < \vartheta_{j+1}, \gamma_2 < \vartheta_j \}$, which accounts for the probability that only γ_1 lies in the field $[\vartheta_j, \vartheta_{j+1})$ while γ_2 is less than ϑ_j , is derived in the following.

$$\begin{aligned} &P \{ \vartheta_j \leq \gamma_1 < \vartheta_{j+1}, \gamma_2 < \vartheta_j \} \\ &= P \{ \vartheta_j \leq \gamma_1 < \vartheta_{j+1}, \gamma_i < \vartheta_j, i = 2, \dots, M \} \\ &= \binom{N}{1} \int_{\vartheta_j}^{\vartheta_{j+1}} 1/\bar{\gamma}_{rd} e^{-\gamma_1/\bar{\gamma}_{rd}} d\gamma_1 \prod_{i=1}^{M-1} \int_0^{\vartheta_j} 1/\bar{\gamma}_{rd} e^{-\gamma_i/\bar{\gamma}_{rd}} d\gamma_i \\ &= \binom{N}{1} \left(e^{-\vartheta_j/\bar{\gamma}_{rd}} - e^{-\vartheta_{j+1}/\bar{\gamma}_{rd}} \right) \left(1 - e^{-\vartheta_j/\bar{\gamma}_{rd}} \right)^{M-1}. \end{aligned} \quad (18)$$

Averaging P_{col} over M , we have:

$$\begin{aligned}\bar{P}_{col}(\vartheta_j, m) &= \sum_{M=0}^N P(N, M) P_{col}(\vartheta_j, m, M) \\ &= \sum_{M=0}^N P(N, M) \left(\sum_{j=1}^m P\{\gamma_1, \gamma_2 \in [\vartheta_j, \vartheta_j]\} \right).\end{aligned}\quad (19)$$

Thus, we derive the closed-form expression of the average collision probability among different relay node, \bar{P}_{col} as a function of the threshold values $\vartheta_j, j = 1, 2, \dots, m$.

D. Probability of Different Virtual Time Slot Duration

The probability PT_j , which is needed in Eq. (17), is the probability of the first relay node to transmit at the j th time slot when there are M qualified relay nodes in the network. It can be calculated as:

$$PT_j(\vartheta_j, m, M) = P\{\gamma_1 \in [\vartheta_j, \vartheta_{j+1}]\}, j = 1, 2, \dots, m. \quad (20)$$

where,

$$\begin{aligned}P\{\gamma_1 \in [\vartheta_j, \vartheta_{j+1}]\} &= P\{\gamma_1 < \vartheta_{j+1}\} - P\{\gamma_1 < \vartheta_j\}. \\ &= \left(1 - e^{-\vartheta_{j+1}/\bar{\gamma}_{rd}}\right)^M - \left(1 - e^{-\vartheta_j/\bar{\gamma}_{rd}}\right)^M.\end{aligned}\quad (21)$$

Averaging PT_j over M , we have $\overline{PT_j}$:

$$\overline{PT_j}(\vartheta_j, m) = \sum_{M=0}^N P(N, M) PT_j(\vartheta_j, m, M). \quad (22)$$

E. Optimization Statement

Finally, the throughput of the cooperative retransmission scheme, η , can be obtained by taking all the relevant equations into Eqs. (16) and (17), and then substituting them into Eq. (3). In this way, with given relay topology in the network and channel conditions, the throughput can be expressed as a function of $\vartheta_j, j = 1, 2, \dots, m$, and optimal values of ϑ_j should be derived to maximize the system throughput. The optimization problem

can be formulated as follows:

$$\begin{aligned}
 & \text{Maximize } \{\eta(\vartheta_j, m)\}, j = 1, 2, \dots, m \\
 & \text{subject to } : \vartheta_{j+1} - \vartheta_j \geq 0, j = 1, 2, \dots, m, \\
 & m = \left\lfloor \frac{DIFS - SIFS}{slottime} \right\rfloor.
 \end{aligned} \tag{23}$$

V. SIMULATIONS AND NUMERICAL RESULTS

The simulation parameters are set up according to the 802.11g standard, as listed in Table B.2. S and D are placed 300 meters apart from each other. Fifty relay nodes are placed randomly within a radius of 30 meters around the destination node. The channels between each transmission pair are implemented as independent Rayleigh fading channels. Two parameters, ϑ_1 and ϑ_2 , will to be tuned to optimize the network throughput.

TABLE B.2: Simulation Parameters (802.11g).

| | | | |
|-------------|------------|------------|------------|
| DATA length | 500 Bytes | CW_{min} | 15 |
| ACK length | 14 Bytes | CFC length | 14 Bytes |
| MPDU header | 24 Bytes | DIFS | 34 μs |
| PHY header | 20 μs | SIFS | 16 μs |
| Datarate | 12 Mbps | Slottime | 9 μs |

The analysis is verified through simulations, with the case $\theta_1=2.0$ dB, $\theta_2=5.0$ dB as an example, shown in Fig. B.3. We can observe that the simulations results coincide with the analysis to a satisfactory extent. The peak of throughput when E_b/N_0 is -3 dB is caused by the most efficient cooperative retransmission in that condition¹. When E_b/N_0 is above 0 dB, direct link quality gets better and fewer cooperations are needed.

Fig. B.4 illustrates the influence of different threshold values on the packet delivery ratio through analysis. It is obvious that the performance of the cooperative scheme with high density of relay nodes is highly affected by the different threshold values. It indicates that the network performance can be improved significantly by reducing the collision probability through the optimal threshold values. In this figure, θ_1 and θ_2 should be set to 2.5 dB and 5 dB respectively, and the resulted optimal PDR is 0.65.

¹When $E_b/N_0 \leq -3$ dB, there are fewer relays qualified for cooperation. On the other hand, when E_b/N_0 is higher, there are more qualified relays contending for the channel and therefore more collisions.

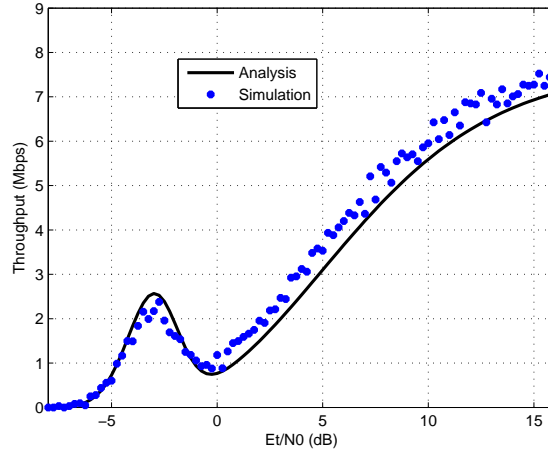

FIGURE B.3: Simulations vs Analysis ($\theta_1=2.0$ dB, $\theta_2=5.0$ dB).

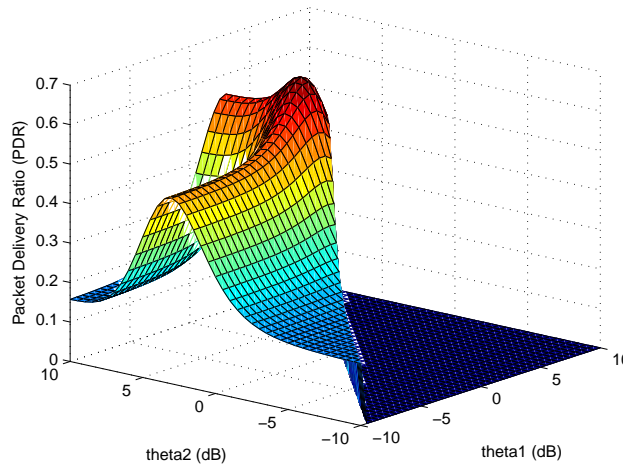

FIGURE B.4: PDR with Different Threshold Values ($E_b/N_0=0$).

The throughput improvement by using the optimized relay scheme compared with the original C-ARQ scheme is shown in Fig. F.5. It can be observed that the optimal relay scheme has shown significant advantage over both C-ARQ and DCF protocols. C-ARQ has its benefits from cooperative retransmission only when the channel is in poor conditions ($E_b/N_0 \leq 5$ dB). When the channel gets better, the probability of collisions among different relays increases. That is why the throughput performance of C-ARQ is seriously degraded and becomes even inferior to the non-cooperative DCF scheme when E_b/N_0 is between 5 dB and 20 dB.

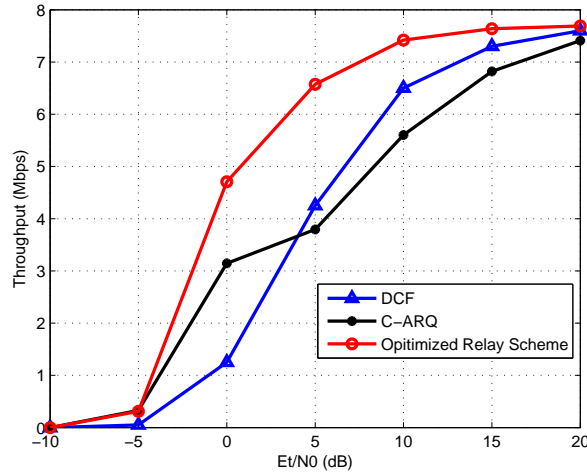

FIGURE B.5: Throughput Performance Comparison ($SNR_{low}=2.0$ dB).

VI. CONCLUSIONS

Collisions among different relay nodes can severely degrade the network performance in a cooperative network with high density of relay nodes. In this paper, we presented a complete analysis of the C-ARQ protocol performance with impairment resulted from collision. Thereby, an optimized relay selection scheme is proposed to maximize system throughput. The analysis and simulation results coincide with each other, and significant throughput enhancement is shown when the proposed optimal relay scheme is applied.

References

- [1] J. N. Laneman, D. N. C. Tse, and G. W. Wornell, “Cooperative Diversity in Wireless Networks: Efficient Protocols and Outage Behavior”. *IEEE Trans. Inform. Theory*, Vol. 50, No. 12, pp. 3062-3080, Dec. 2004.
- [2] S. Valentin, H. S. Lichte, and H. Karl, “Cooperative Wireless Networking Beyond Store-and-forward: Perspectives in PHY and MAC Design”. *Wireless Personal Communications*, Vol. 48, No.1, pp. 49-68. 2009.
- [3] J. Alonso-Zárate, E. Kartsakli, C. Verikoukis, and L. Alonso, “Persistent RC-SMA: A MAC Protocol for a Distributed Cooperative ARQ Scheme in Wireless

- Networks”. *EURASIP Journal on Advances in Signal Processing*, Vol. 2008, doi: 10.1155/2008/817401, pp. 13, May. 2008.
- [4] P. Liu, Z. Tao, and S. Narayanan, “CoopMAC: A Cooperative MAC for Wireless LANs”. *IEEE JSAC*, Vol. 25, No. 2, pp. 340-354, Feb. 2007.
- [5] X. He, F. Y. Li, “Cooperative MAC Design in Multi-hop Wireless Networks: Part I: When Source and Destination are within the Transmission Range of Each Other”. *Wireless Personal Communications*, Springer, doi: 10.1007/s11277-010-0072-y, July 2010.
- [6] A. Bletsas, A. Khisti, and D. P. Reed, “A Simple Cooperative Diversity Method based on Network Path Selection”. *IEEE JSAC*, Vol. 24, No. 3 pp. 695-672, March 2006.
- [7] M. G. Jibukumar, R. Datta, and P. K. Biswas, “CoopMACA: a Cooperative MAC Protocol using Packet Aggregation”. *Wireless Networks*, Springer, doi: 10.1007/s11276-009-0232-8, Dec. 2009.
- [8] J. Gómez, J. Alonso-Zárate, C. Verikoukis, A. Pérez-Neira, and L. Alonso, “Cooperation on Demand Protocols for Wireless Networks”. In *Proceedings of IEEE PIMRC*, pp. 1-5, Sept. 2007.
- [9] X. He, F. Y. Li, “Energy Consumption and Optimal Relay Node Placement for Cooperative Retransmissions”. In *Proceedings of IEEE ISWCS*, pp. 1-6, Sept. 2010.
- [10] Q. Liu, S. Zhou, and G. B. Giannakis, “Cross-Layer Combining of Adaptive Modulation and Coding with Truncated ARQ over Wireless Links”. *IEEE Trans. Comm.*, Vol. 3, No. 5, pp. 1746-1755, Sept. 2004.

FORMAL VERIFICATION OF A COOPERATIVE AUTOMATIC REPEAT REQUEST MAC PROTOCOL

Title: Formal Verification of a Cooperative Automatic Repeat re-
Quest MAC Protocol

Authors: Xin He, Ram Kumar, Liping Mu, Terje Gjøsæter and Frank
Y. Li

Affiliation: Department of Information and Communication Technol-
ogy, University of Agder, P. O. Box 509, N-4898 Grimstad,
Norway

Journal: *Computer Standards & Interfaces*, Elsevier,
DOI:10.1016/j.csi.2011.12.001, online Jan. 2012.

Copyright: ©Elsevier

Formal Verification of a Cooperative Automatic Repeat reQuest MAC Protocol

Xin He, Ram Kumar, Liping Mu, Terje Gjørseter and Frank Y. Li

Dept. of Information and Communication Technology,

University of Agder (UiA)

N-4898 Grimstad, Norway

Email: {xin.he, liping.mu, ram.kumar, terje.gjosater, frank.li}@uia.no

Abstract — Cooperative communications, in which a relay node helps the source node to deliver its packets to the destination node, are able to obtain significant benefits in terms of transmission reliability, coverage extension and energy efficiency. A Cooperative Automatic Repeat reQuest (*C-ARQ*) MAC protocol has been recently proposed to exploit cooperative diversity at the MAC layer. In this paper, we validate the integrity and the validity of the *C-ARQ* protocol using formal methods. The protocol logic is modeled in SDL and implemented in PROMELA. The functionality of the *C-ARQ* protocol is verified through simulations and verifications using SPIN.

Keywords— Cooperative communications; Finite model-checking; Protocol verification; PROMELA

I. INTRODUCTION

With the development of advanced radio communication technologies, wireless networks have been widely accepted as a last-mile solution to provide ubiquitous access to Internet services. Different from wired transmission, broadcast is an inherent feature of wireless transmission, i.e., the information transmitted from a source node can be received not only by the destination node, but also by neighboring nodes surrounding the source. In traditional wireless networks, such signals received by the neighboring nodes are treated as interference and many techniques have been developed to alleviate their

impact. However, such signals actually contain useful information for the destination node. In fact, if the information can be properly forwarded by the surrounding node(s), the reception performance at the destination could be improved. This fact indeed motivates the application of a new technology, known as cooperative communications [1].

The theory behind cooperative communications has been studied in depth and significant improvement of system performance has been demonstrated in terms of transmission reliability, network coverage and energy efficiency [2]. Meanwhile, cooperative Media Access Control (MAC) protocol design for wireless distributed networks is attracting more and more attention within the research community [3–5]. From the MAC design perspective, three key issues need to be addressed. a) *when to cooperate*: Since the quality of wireless channels varies with time, a source node may not always need help from relay nodes. Therefore, it is more sensible that cooperation is initiated only when it is necessary and beneficial. b) *whom to cooperate with*: One or more appropriate relay nodes need to be selected among multiple potential relay nodes in the network. In a distributed network where there is no central controller that can coordinate data transmissions of all relays, relay selection becomes a challenging task. Without an efficient relay selection scheme, collisions might happen frequently when several potential relays are contending for channel access at the same time. c) *how to protect cooperative transmissions*: The MAC protocol should be carefully designed to protect all ongoing transmission sequences against potential collisions from any other nodes in the vicinity.

A novel Cooperative Automatic Repeat reQuest protocol (C-ARQ) which addresses the aforementioned three issues concerning cooperative transmissions at the MAC layer has been proposed [6] based on the Distributed Coordination Function (DCF) scheme for Wireless Local Networks. According to C-ARQ, cooperative transmission is initiated only when the direct transmission fails. In this way, unnecessary occupation of channels by relay nodes and waste of system resources are avoided. Secondly, the relay nodes are sorted with different backoff time before data transmission according to instantaneous relay channel quality, and the relay node with best relay channel quality will be selected automatically to forward the data packet first. Finally, the cooperative transmission sequences are specifically designed to give cooperative retransmissions higher priority for channel access in order to protect ongoing packet forwarding by relay nodes.

Numerous approaches exist to verify the correctness and feasibility of a new protocol. One is by experimentation in real-life scenarios. Another well-known approach is via the use of formal methods. Model checking is one such method, which consists of constructing a computer tractable description (formal model) of the protocol and then using a specific automatic (or semi-automatic) analysis technique to prove or to check the satisfaction of a given set of critical properties [7, 8]. Model checking can be used to formally verify finite-state concurrent systems. Specifications about the system are expressed as temporal logic formulas. Symbolic algorithms are used to traverse the model defined by the system and check if the specification holds or not. Analyzing a protocol with model checking consists of primarily constructing an abstract description, or a model, of the protocol with the main features that could produce execution errors. The reliability properties of the protocol are specified using a property-oriented language. Finally, the reachability graph is produced including all the execution paths for the model in order to check whether these paths satisfy the properties. It has been widely used to formally verify communication protocols with model checking techniques. Related work can be found in references [10]–[14].

The goal of this paper is to verify the functionality of the C-ARQ MAC protocol using formal model checking methods. To do so, we use the *Specification and Description Language* (SDL) to specify and visualize a formal model for the cooperative system. Furthermore, *Process or Protocol Meta Language* (PROMELA) is employed along with the Sequential Programming in PROMELA (SPIN) model checker to verify the integrity and validity of the C-ARQ protocol. Different network scenarios are simulated, and verifications are carried out through never-claims, using the Linear Temporal Logic (LTL) formula in SPIN.

The remainder of the paper is organized as follows. In Section II, the system model and the C-ARQ protocol are explained in details. In Section III, we introduce the SPIN model checker and PROMELA. In further sections, we describe the SDL model for our protocol (Section IV), and explain the simulation and verification results (Sections V and VI) from the SPIN model checker. The main challenges and difficulties of the model checking of the proposal are summarized in Section VII. Finally, we conclude the paper in Section VIII.

II. C-ARQ PROTOCOL DESCRIPTION

II.A System Model for Cooperative Transmission

The C-ARQ protocol is based on the Carrier Sense Multiple Access with Collision Avoidance (CSMA/CA) mechanism in a single-hop scenario, where the source and the destination can hear each other, and there is only one node sending packets at any time. Hence, we use the network in Fig.G.1 for illustrating the cooperative protocol procedure [6]. The network consists of a source node, S, a destination node, D, and several other randomly distributed potential relay nodes, R_1, R_2, \dots, R_n .

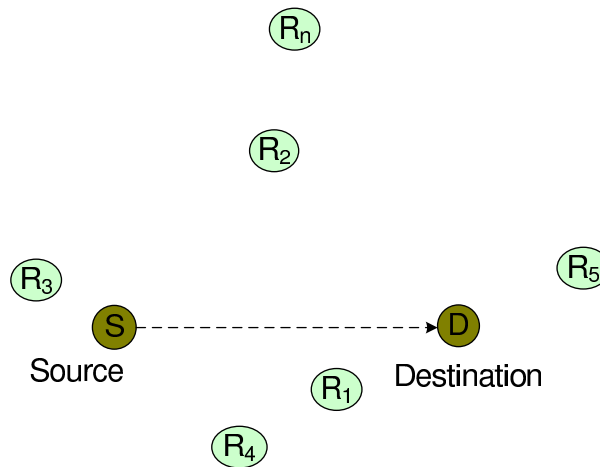

FIGURE C.1: System Model for Cooperative Transmission.

In this model, S and D are within the transmission range of each other. Each packet transmission cycle starts from S, with the intended destination as D. Other nodes in the network that can hear both the source node and the destination node and have correctly decoded the data packets they capture from the direct link become relay candidates. The cooperative retransmission is initiated only when the direct transmission fails. The relay nodes with top relay channel quality will be automatically selected to forward the DATA packet to the destination following the C-ARQ protocol.

Furthermore, this network model can be easily extended to a multi-hop scenario, where the single-hop link in our model, including the relay nodes, acts as a virtual node along the whole transmission path.

II.B C-ARQ MAC Protocol Description

The message exchange sequence of the C-ARQ basic access scheme is illustrated in Fig.C.2 [6]. It has four operation cases, as Case I: direct transmission succeeds; Case II: best-relay-channel retransmission succeeds; Case III: multi-relay retransmission succeeds; and Case IV: the whole cooperative retransmission fails. These cases are further elaborated in the following.

Case I: As the first step, the source node, S, sends out a DATA packet to destination D following the original DCF basic access scheme [9]. According to the DCF protocol shown in Fig.C.2(a), S listens to the channel for a DCF InterFrame Space (DIFS) interval and then waits for a random backoff time before transmission in order to avoid possible collision. If the transmission succeeds, an acknowledgment (ACK) frame will be returned to the source node after a Short InterFrame Space (SIFS) interval.

Case II: As mentioned earlier, if and only if the data packet is received erroneously at D, the cooperative phase will be initiated. The error-check can be performed by means of Cyclic Redundancy Check (CRC). As shown in Fig.C.2(b), D broadcasts a Call For Cooperation (CFC) packet after SIFS to invite other nodes in the network to operate as relay nodes and at the same time provides them with the opportunity of measuring their respective relay channel quality. The CFC frame adopts a similar format as the ACK frame but with a broadcast address in its address field. It is transmitted at the basic data rate in order to invite as many relay nodes as possible. Having received both the CFC packet and the DATA packet correctly, each relay candidate will measure the signal strength of its received CFC packet, and if the Signal-to-Noise Ratio (SNR) exceeds SNR_{low} , the relay candidate will start its timer according to Eq. (1) [6].

$$T_i = \left\lceil \frac{SNR_{low} DIFS - SIFS}{SNR_i \text{ slottime}} \right\rceil, \quad i = 1, 2 \dots n \quad (1)$$

where T_i is the backoff time at relay node R_i , defined as an integer in number of microseconds; SNR_i is the SNR value in dB of the received packet from D measured at R_i ; SNR_{low} is the threshold of SNR_i for R_i to participate in cooperative retransmission; and n is the number of relay nodes in the network. The upper bound of the backoff

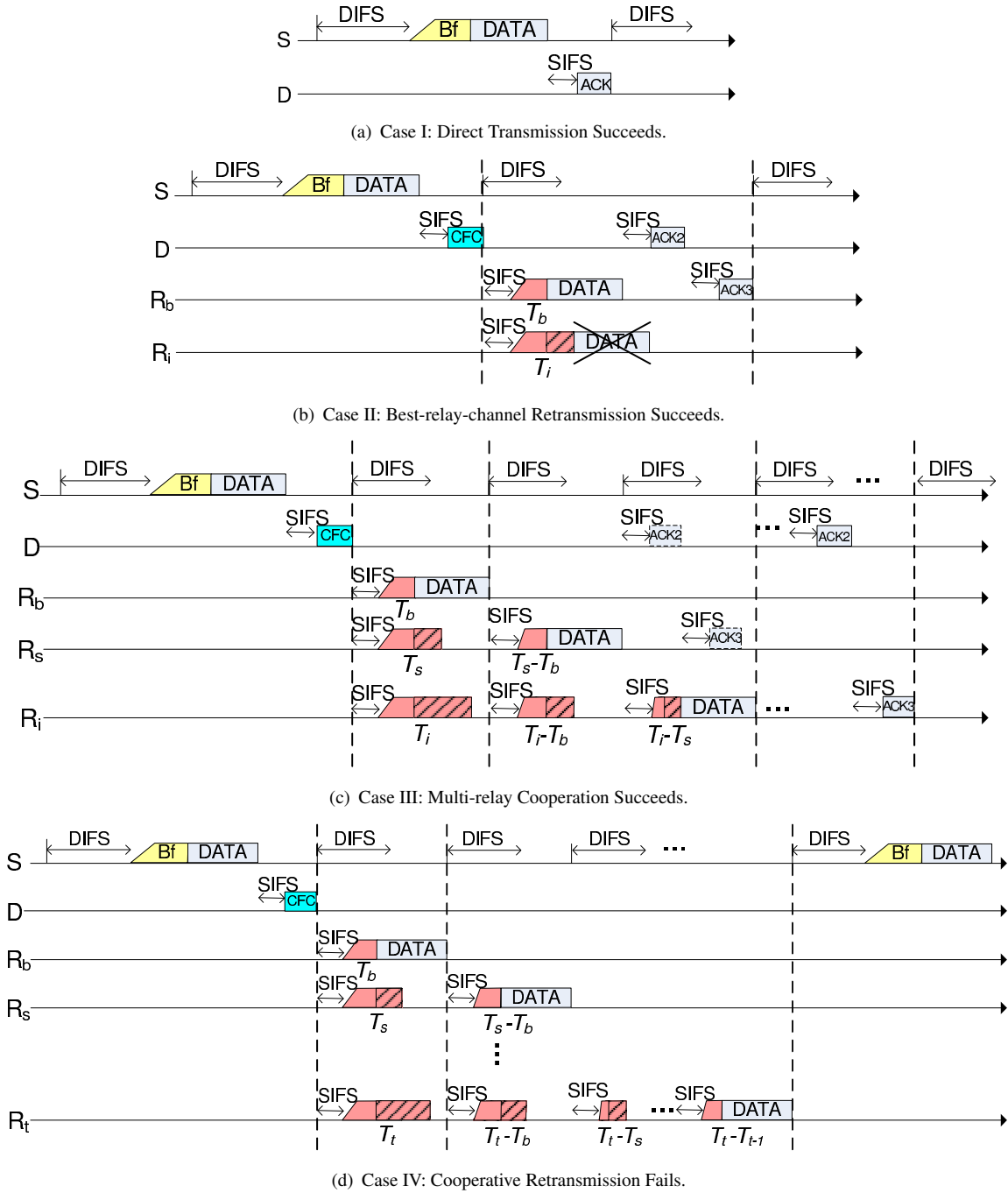

FIGURE C.2: C-ARQ Basic Access Scheme.

time for relay candidates is $DIFS - SIFS$ in order to prioritize the relay nodes for cooperative retransmissions among other contending nodes in the network. The granularity of T_i is specified to be *slottime* of the system in order to cover the propagation delay in the network.

According to Eq.(1), the relay node with the best relay channel quality, R_b , which observes the strongest received signal and thus has the shortest backoff time T_b , will first get access to the channel and forward its received packet to the destination. When the other relay candidates hear the packet sent by R_b , they will freeze their timer and keep on listening to the channel. More details about the automatic relay selection scheme can be found in [6].

Moreover, the granularity of the back-off time, T_i , can be adjusted according to specific network scenarios. For example, the granularity can be refined to $1 \mu s$, which is enough to distinguish signals sent from two stations that are 300 m away from each other. In our description, we use slottime as the granularity in order to keep the legacy of the 802.11 standard. In this case, there are only two slottime durations between DIFS and SIFS, which means three backoff durations, can be allocated to different relays, i.e. 0, 1 or 2 slottime durations. This scheme works well on a sparse network with less than 10 relay nodes [15]. However, the performance will be degraded due to high collision probabilities among relays in a dense network. Hence, an optimization scheme has been proposed in another follow-up work [16], aiming at minimizing the relay collision probability in a dense network by optimizing the backoff time allocation scheme. Significant throughput enhancement has been shown by both analysis and simulations when the proposed optimal relay scheme is applied.

As shown in Fig.C.2(b), after the direct transmission fails, S keeps listening to the channel for the next data transmission. If there are no relay nodes in the network that satisfy the relay selection criterion, S will obtain the channel access after DIFS and a random backoff time. If D decodes the packet correctly after the best-relay-channel retransmission, D will return an ACK2 packet, which is relayed afterwards as ACK3 by R_b to S in order to guarantee a reliable ACK transmission. All the relay nodes will reset their timer and discard the packets they have received after they detect the ACK2 packet sent by D. Thus, the cooperative retransmission phase is completed.

Case III: Cooperative retransmission failure can be caused either by collisions among two or more relay nodes with the same backoff time T_b or by data corruption on the transmission channel. In this case, no ACK2 packet is sensed from the channel, and the other relay nodes will reactivate their timers simultaneously after the ACK timeout, as shown in Fig. C.2(c). Following the same procedure as the best-relay-channel retransmission,

the timer of the relay node with the second-best-relay-channel R_s will expire first this time and R_s will forward the packet prior to the other relays. An ACK packet will be returned if the second-best-relay-channel retransmission succeeds. The same as in Case II, other relay nodes will freeze their timers during the second-best-relay-channel retransmission and reactivate them after ACK2 timeout. As shown in Fig.C.2(c), the relay nodes will participate in data retransmission consecutively one after another until D decodes the packet successfully and responds with an ACK2 packet. Whenever the ACK2 packet is detected, the remaining relay candidates will reset their timers and discard their received packets, and the cooperative transmission cycle is thus completed.

Case IV: If the cooperation of all relay nodes still does not lead to successful data reception at D, or if the number of retransmission attempt reaches the retry limit, the cooperative transmission fails. As shown in Fig. C.2(d), the source node will then obtain channel access again for another round of packet transmission, following the same procedure as described above.

III. SPIN AND PROMELA

The terminology for mathematical demonstration of the correctness of a system is *formal verification* [7] and can be accomplished using the SPIN model checker [17]. SPIN is a general tool for formal verification of distributed software systems. It can be used as a simulator for rapid prototyping with random, guided, or interactive simulations, and it can also be used as an exhaustive verifier proving the validity of user specified correctness requirements.

Models that are analyzed in SPIN must be specified in an internal specification language called PROMELA [7], a verification modeling language providing a way for making abstractions of distributed systems. It attempts to abstract as much as possible from internal sequential computations, focusing on the expression of only essential properties of modeled systems in order to verify whether the process interactions are correct or not. In PROMELA we can specify all essential features of distributed asynchronous systems such as the behavior of nodes or processes (abbreviated as CFMSs), communication channels, and utilize global variables to define the environment in which the processes run. PROMELA allows the dynamic creation of concurrent processes communicating

via message channels. Based on a system model specified in PROMELA, SPIN can perform random simulations of the system execution or efficient on-the-fly verification of the system correctness properties [11].

Correctness claims can be specified in the syntax of standard LTL, a model temporal logic with modalities referring to time. Using LTL one can express properties of paths in a computation tree. There are mainly two types of properties that can be expressed in LTL: safety properties (something bad never happens) and liveness properties (something good keeps happening). SPIN does exhaustive search and produces fast programs (called validators), and can be used in different modes. For small to medium size models, the validators can be used with an exhaustive state space. The result of all validations performed in this mode is equivalent to an exhaustive proof of correctness, for the correctness requirements that were specified. For larger systems, the validators can also be used in supertrace mode, with the bit state space technique. In these cases the validations can be performed using much less memory, and still retain excellent coverage of the state space [18].

IV. ABSTRACTION AND MODELING

We use the SDL language to specify and visualize a formal model for the above presented protocol. SDL can provide us with unambiguous specification and description of the behavior of our system. While it is possible to specify a more generic model for any node (irrespective of its function being Sender, Destination or Relay), we have modeled the behavior separately for better understanding and ease of use. Without losing generality, two relay nodes (Relay R and Relay H) are adopted in our model besides the source node (S) and the destination (D) to illustrate the cooperative procedure. Our model is implemented based on several necessary assumptions:

- *All nodes which are involved in cooperative transmissions can hear each other.*
- *The receiving nodes can always receive the DATA packet from the channel, no matter it is decoded as correct or not.*
- *The ACK and CFC packets are always received correctly.*
- *Between the two relay nodes, R represents the relay node with better relay channel condition hence is chosen to retransmit first.*

The reasons for the above strong assumptions are listed in the following. This novel C-ARQ protocol targets typical wireless local network scenarios where the involved nodes are one-hop away from each other. It can be an infrastructure network or one-hop neighborhood in an ad hoc network. In an infrastructure network like the current WiFi networks, the nodes are typically densely distributed. The distance between the source and the destination node is usually quite short. In an ad hoc network, a routing protocol will find out the next hop destination. This cooperative scheme will be implemented between the sender and its next hop destination. Therefore, we have the assumption that all the nodes can hear each other and that the ACK and CFC packets will be decoded correctly due to their small packet lengths.

On the other hand, there exist problems like collisions of packets that would cause packet loss in reality. Those problems are inherited from traditional wireless local networks. However, cooperative communications have no contributions towards these problems. This paper focuses on the benefits that cooperative communications can bring in. Therefore, the existing mechanisms like the back-off procedure and the RTS/CTS handshaking procedure, which are introduced to solve the collisions and hidden terminal problems, are not included in our modeling. One reason is that it will for sure dramatically increase the complexity, and another reason is that it might also blur the focus of this study. Given the above considerations, the strict assumptions are made here to simplify the modeling and focus on the cooperative retransmission part of the scheme.

IV.A SDL Model for C-ARQ

The SDL models designed for the sender, S, the destination, D, the optimal relay, R, and second relay H according to the C-ARQ protocol, are shown in Figs. C.3 – C.6 respectively.

In our models, several virtual signals, such as RTimeout, HTimeout, ACK2Timeout and ACK3Timeout, are designed to be transmitted between processes in order to model the timeout function of the nodes in reality, in addition to the normal packets the nodes receive from the wireless channel, e.g., DATA and ACK packets. All these signals are sent in a broadcast way, and all the other nodes in the network will receive and process the signals according to their own state machines. Note that the backoff procedure in the

original DCF scheme is simplified in our model because of its independence from the cooperative protocol.

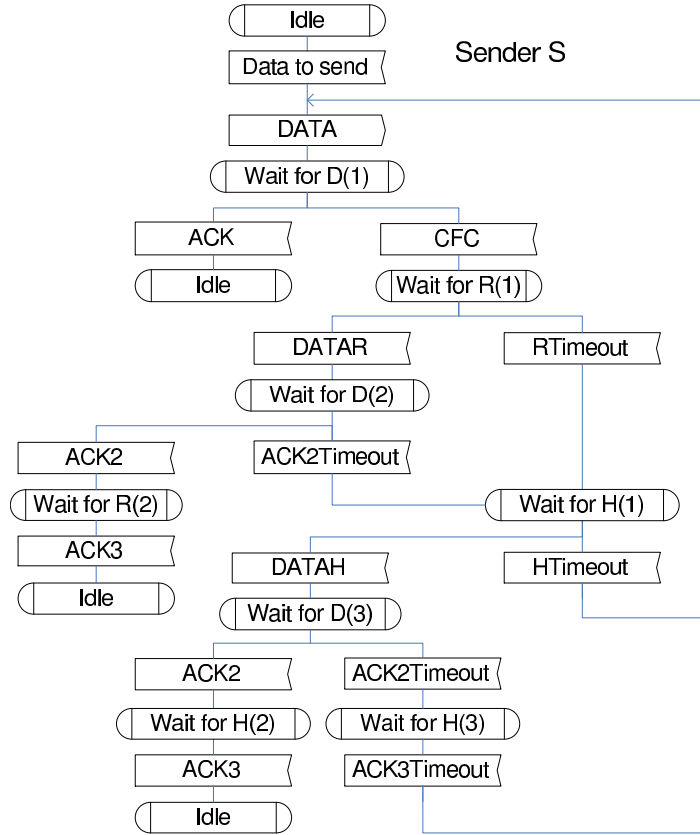

FIGURE C.3: Formal SDL Model for C-ARQ: Sender.

IV.B PROMELA Implementation

For the simplified system model with one Sender, one Destination and two Relays (R and H), we implemented four separate processes in the same environment in PROMELA, one for each node. While it is possible to implement the system as instances of a single generic node which performs various roles, we find it clearer to represent it this way without the loss of protocol logic. In the real world, the messages are exchanged in the wireless channel where every node can receive the messages sent by every other node within its transmission range. For fine grained control over our operating environment, the broadcast concept is implemented as six point-to-point synchronous channels between various nodes (see *Code:Channels* below). In this way, we have control over

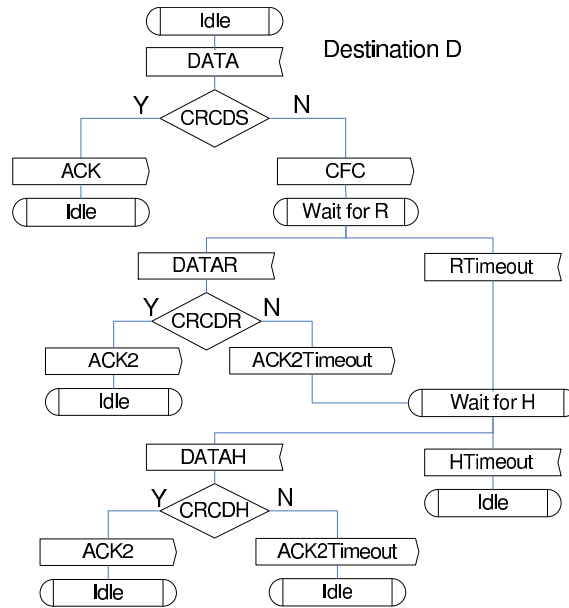

FIGURE C.4: Formal SDL Model for C-ARQ: Destination.

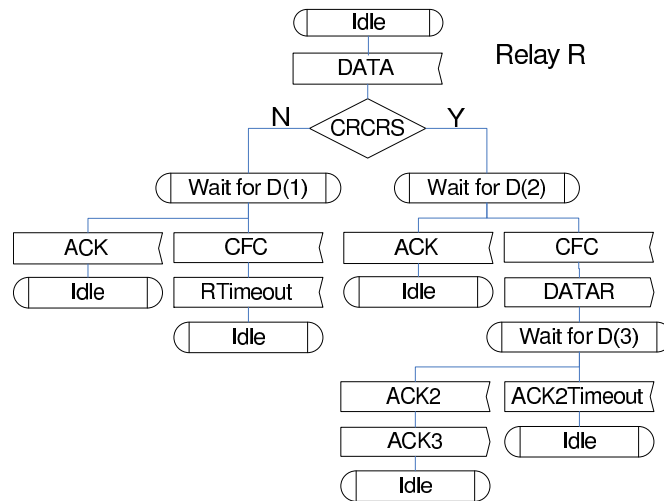

FIGURE C.5: Formal SDL Model for C-ARQ: Relay R.

which message needs to be sent and to which node easily, through the corresponding channel.

```

chan StoD = [0] of {mtype, bool};
chan StoR = [0] of {mtype, bool};
chan RtoD = [0] of {mtype, bool};
chan RtoH = [0] of {mtype, bool};
chan StoH = [0] of {mtype, bool};

```

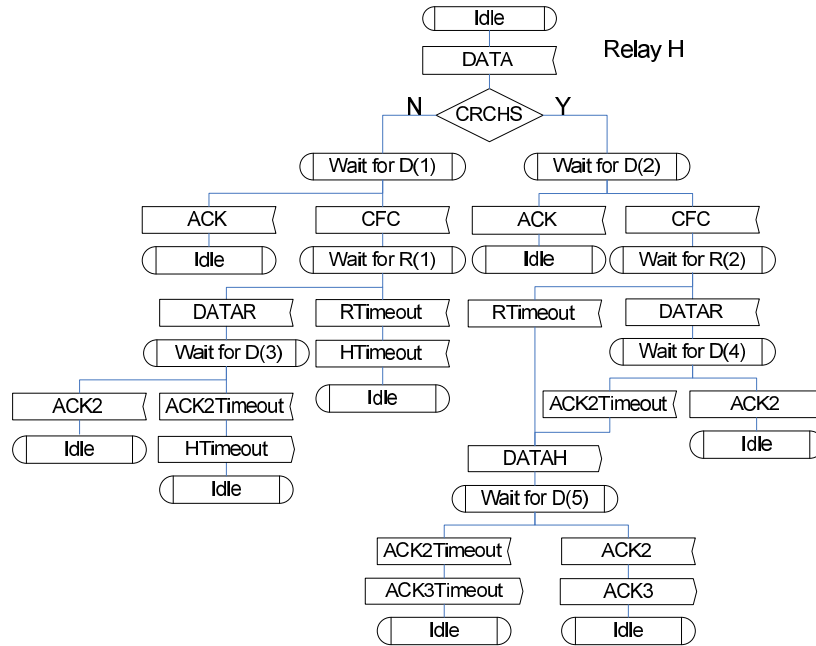

FIGURE C.6: Formal SDL Model for C-ARQ: Relay H.

```
chan HtoD = [0] of {mtype, bool};
```

Since the protocol requires information about the correctness of the received DATA packet at various nodes, we define CRC at various nodes as local variables as indicated below (Code: *CRC variables*):

```
At Sender S: bool CRCDS, CRCRS, CRCHS;
```

```
/*Sent to D, R and H*/
```

```
At Relay R: bool CRCDR; /*CRC sent to D*/
```

```
At Relay H: bool CRCDH; /*CRC sent to D*/
```

The various conditions of the channel are simulated by setting various CRC variables as *True* or *False* between each transmission pair. The variable configuration and simulation results achieved are described later in Section V. Different CRC values are set using a random function at its corresponding receiver, which determines the received CRC value to be true or false randomly during each iteration. The random CRC code at the relay, R, from the direct transmission is taken as an example and shown in (Code: *RandomCRC*). Coupled with the infinite packets being sent at the source node,

the simulation covers all the possibilities that arise from various permutations of the different CRC values.¹

```

/*Random CRC at relay R*/
StoR?tmpRS,tmpCRCRS;
  if
    ::tmpRS==data ->
      do
        :: tmpCRCRS=true; break
        :: tmpCRCRS=false; break
      od;
    .....

StoD?tmpDS,tmpCRCD;
if
  ::tmpDS==DATA ->
  if
    ::tmpCRCD==true ->
      atomic {StoD!ACK,true; RtoD!ACK,true;
              HtoD!ACK,true;}
      /*Correct Data received*/
    ::tmpCRCD==false ->
      atomic {StoD!CFC,true; RtoD!CFC,true;
              HtoD!CFC,true;}
      RtoD?tmpDR,tmpCRCD;
      /*Corrupted Data; call for help*/
  if
    ::tmpDR==RTimeout ->
      HtoD?tmpDH,tmpCRCDH;
      /*Relay R failed; Wait for Relay H*/
    .....

```

¹Note that this channel configuration method is only used here for protocol verification. Wireless channels in reality are subject to time correlated fading and hence the CRC values cannot be randomly set up in every data transmission iteration. More sophisticated and realistic channel models may be investigated for more comprehensive protocol performance evaluation.

The receiver will respond following the C-ARQ protocol based on the CRC checking results of the received DATA packet. For instance, when the destination D receives DATA from the direct channel, according to the result of CRC checking, ACK or CFC will be sent out to the channel respectively.

V. SIMULATION RESULTS

Message generation procedures are simulated in SPIN for all the different cases of the C-ARQ protocol, as described in Section II. From the simulation results shown in Figs. C.7-C.12, we can claim that the protocol works exactly as how it is described for all the given cases. The vertical lines in the simulation message sequence charts in this section indicate the Sender, Destination, Relay R (preferred relay) and Relay H respectively. The difference cases in these figures are explained as follows.

Case I: $CRCDS = true$.

The direct transmission succeeded without need for retransmissions from relays (Fig. C.7).

Case II: $CRCDS = false$; $CRCRS = true$; $CRCDR = true$.

Relay node R which has decoded the DATA packet correctly forwards its DATA packet to the destination successfully after the direct transmission fails (Fig. C.8).

Case III: $CRCDS = false$; $CRCRS = true$; $CRCDR = false$; $CRCHS = true$; $CRCDH = true$.

After the optimal relay retransmission fails, the second relay node, H, which also decoded the packet successfully, forwards the packet successfully to D (Fig. C.9).

Case IV: $CRCDS = false$; ($CRCRS = true$; $CRCDR = false$; $CRCHS = true$; $CRCDH = false$) OR ($CRCRS = true$; $CRCDR = false$; $CRCHS = false$) OR ($CRCRS = false$; $CRCHS = false$).

There are three occasions that may cause the failure of the cooperative retransmission after the direct transmission fails: (a) Both R and H have participated forwarding and both packets are corrupted on the relay channels (Fig. C.10); (b) Only one relay is qualified to participate and the data packet is corrupted (Fig. C.11); (c) Neither of the two relays have decoded the packet successfully. Hence, no cooperative

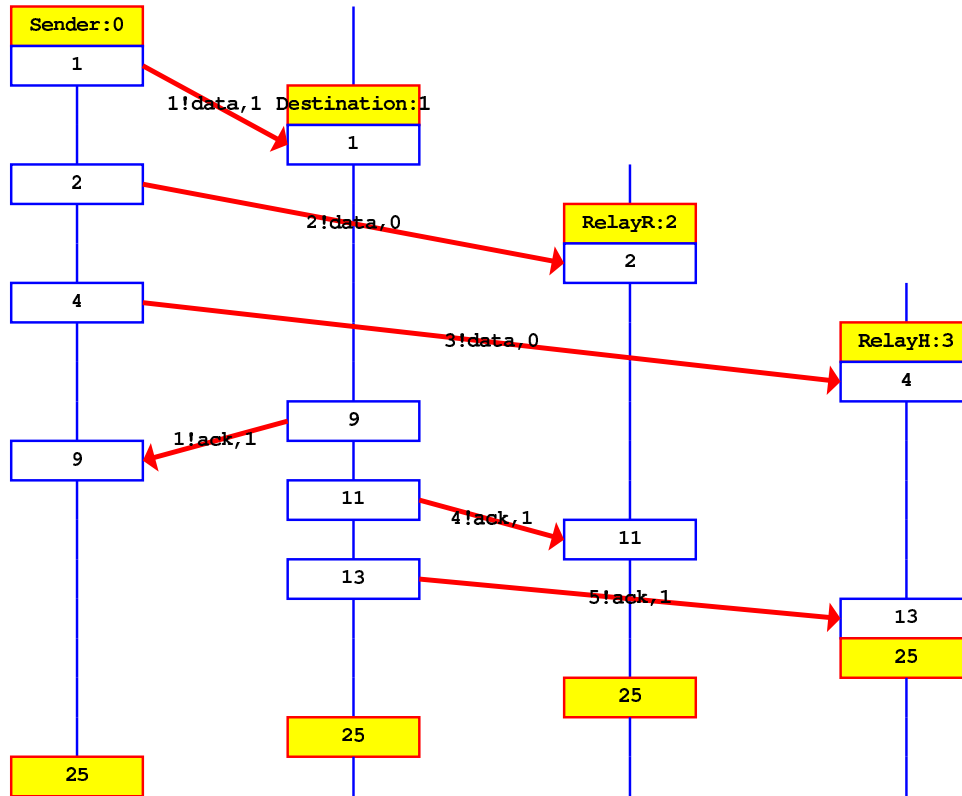

FIGURE C.7: Simulation Result for Case I: Direct Transmission Succeeds.

retransmission happens. In all the three scenarios, the source node S starts to resend the packet after the whole cooperative retransmission procedure fails (Fig. C.12).

VI. VERIFICATION USING SPIN

VI.A Invalid End-States

In PROMELA, valid end-states are those system states in which every process instance has either reached the end of their defining program body or is blocked at a statement that has a label starting with the prefix *end*. Valid end-states also require channels to be empty. All other states are invalid end-states. In all of our verification operations, no invalid end-states were found.

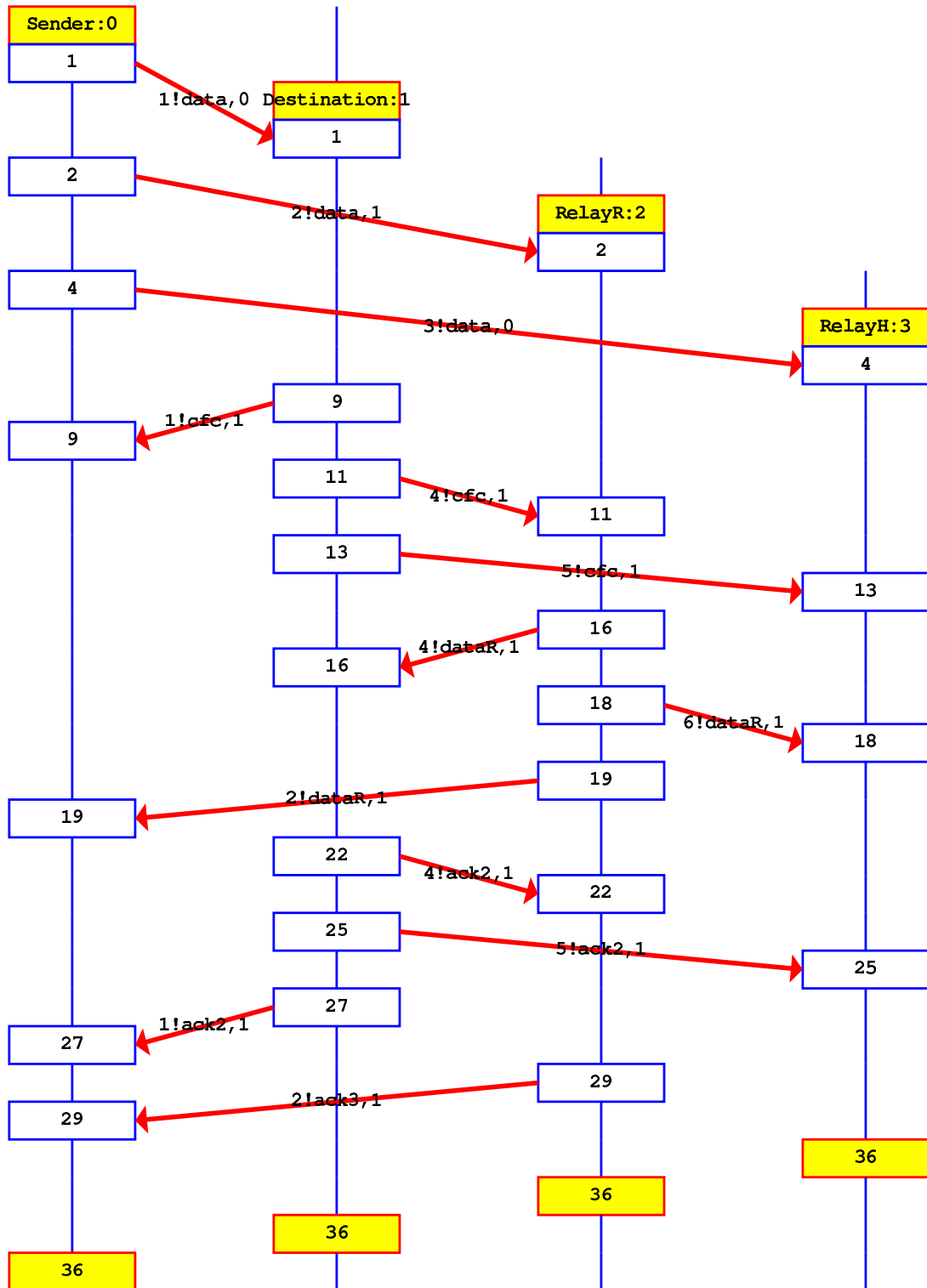

FIGURE C.8: Simulation Result for Case II: Direct Transmission Fails; First Cooperative Retransmission Succeeds.

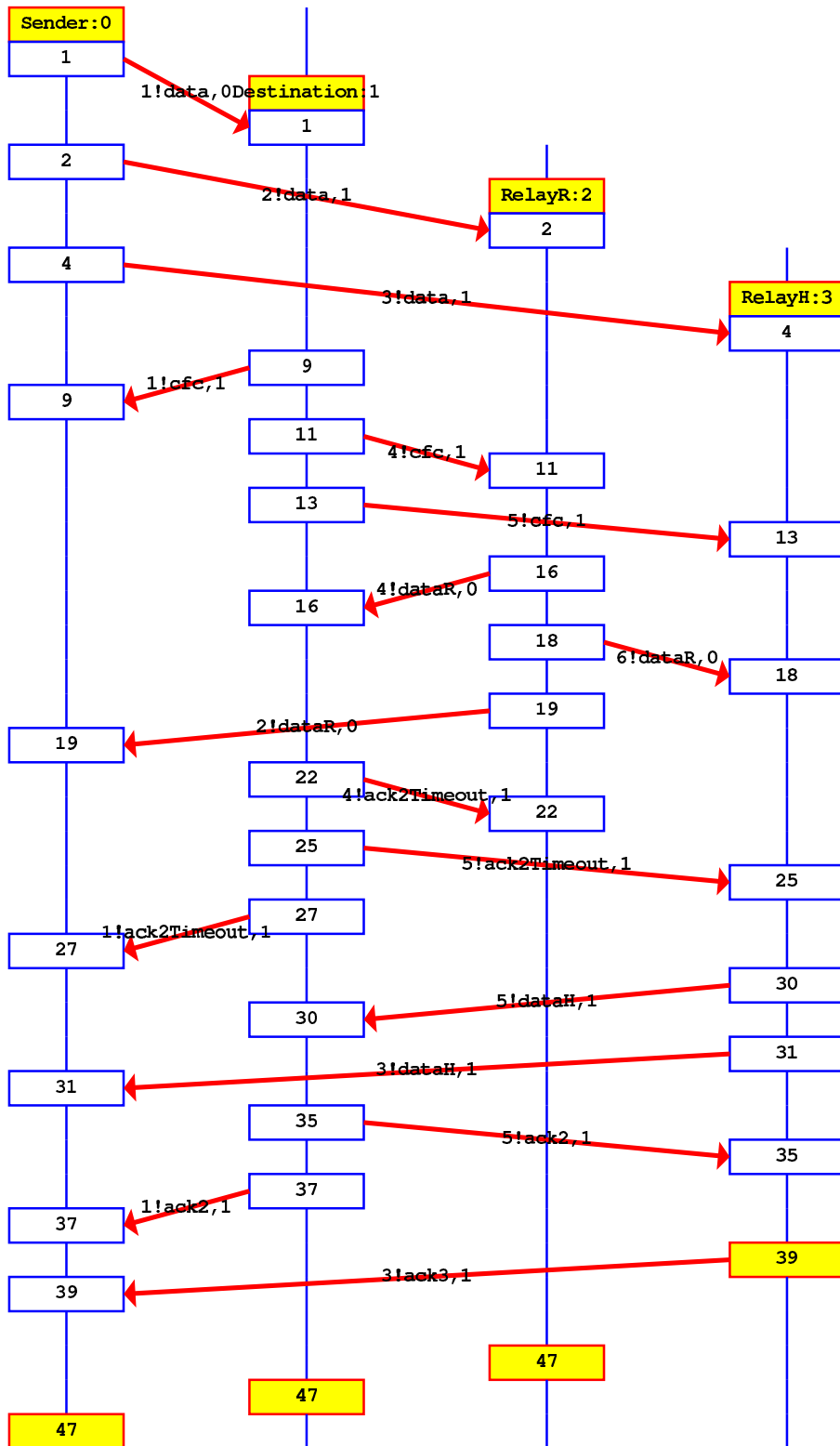

FIGURE C.9: Simulation Result for Case III: Direct Transmission Fails; First Cooperative Retransmission Fails; Second Cooperative Retransmission Succeeds.

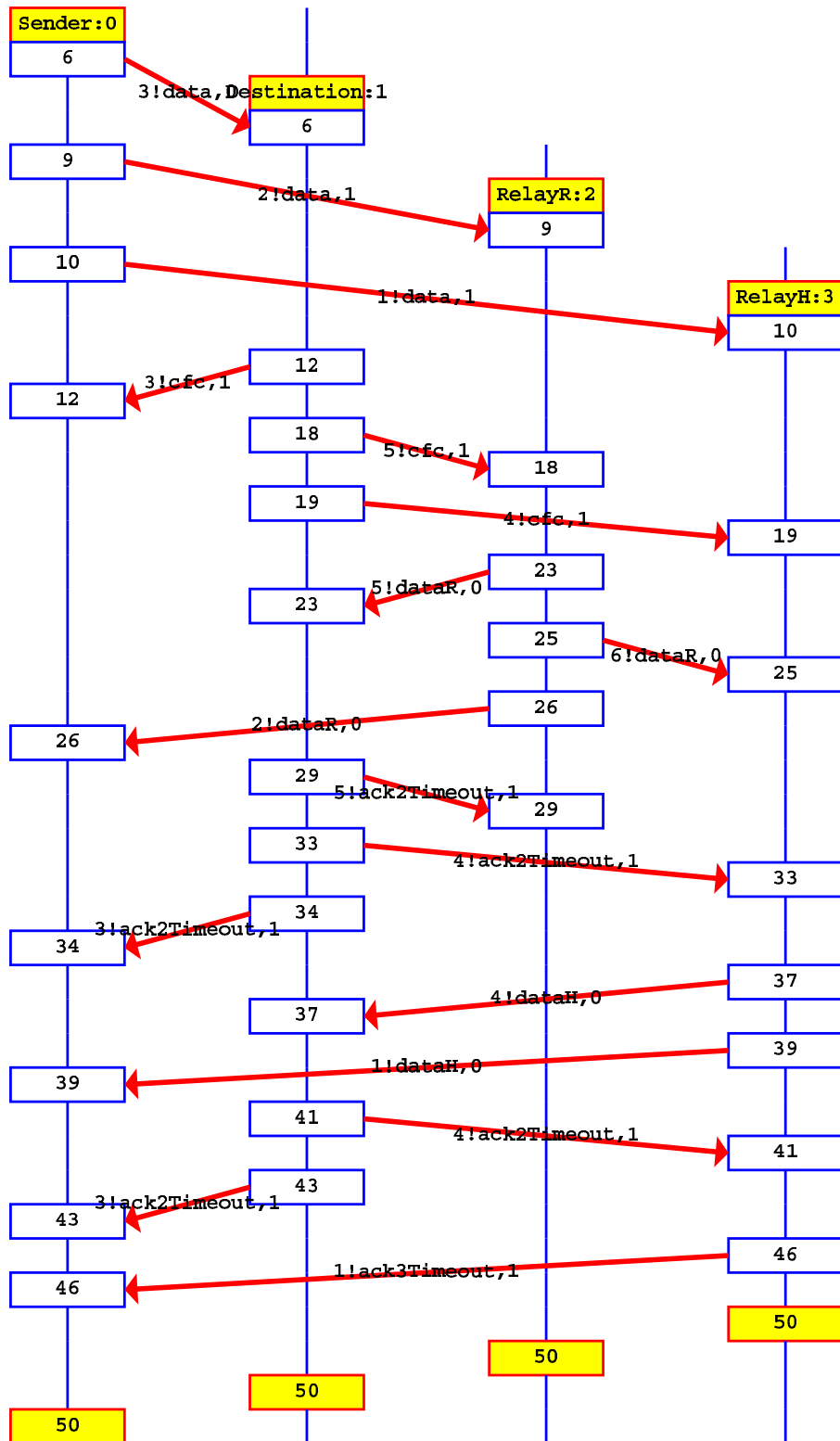

FIGURE C.10: Simulation Result for Case IVa: Cooperative Retransmission Fails: Packet Corruption on Both Qualified Relay Channels.

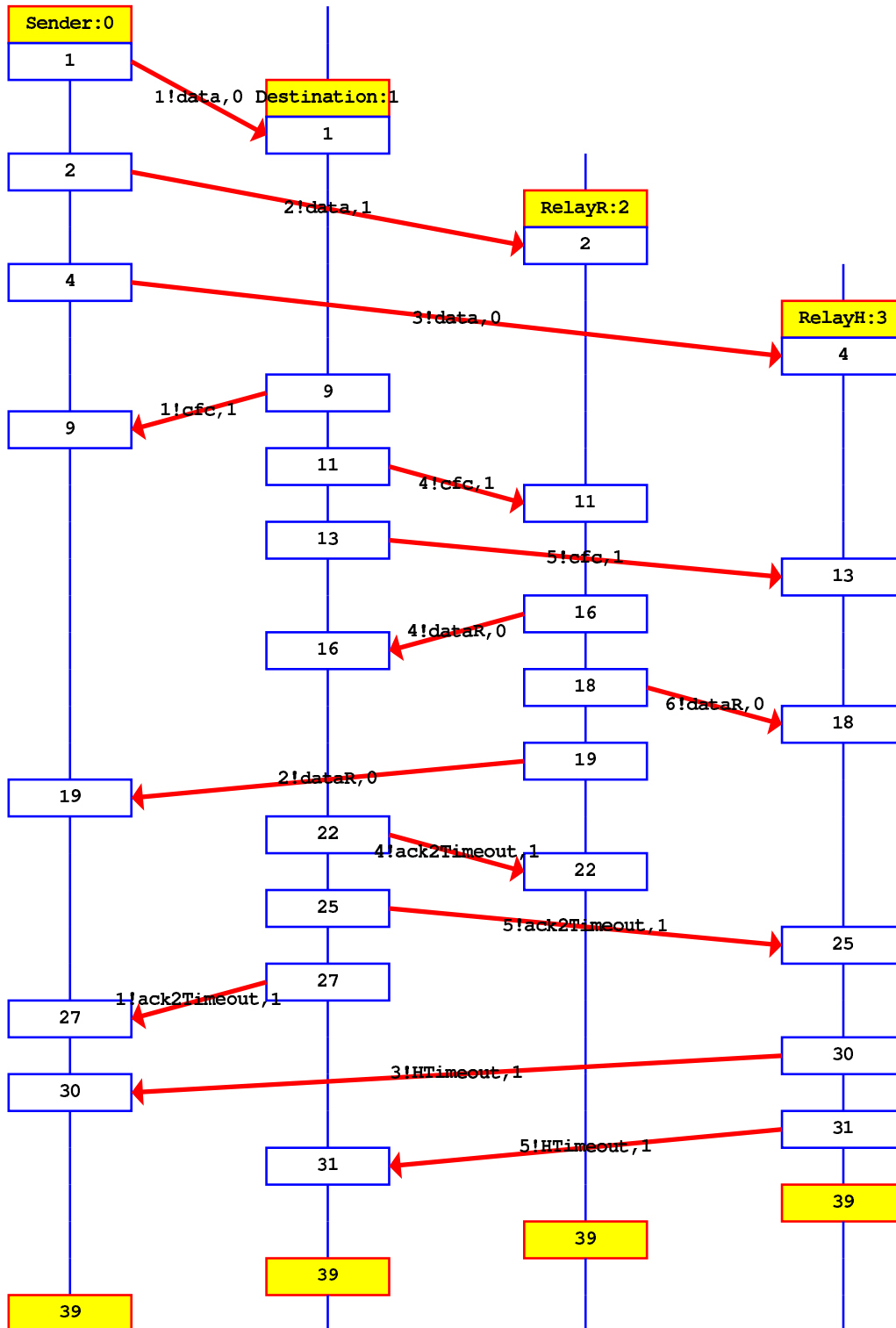

FIGURE C.11: Simulation Result for Case IVb: Cooperative Retransmission Fails: Packet Corruption on Single Qualified Relay Channel.

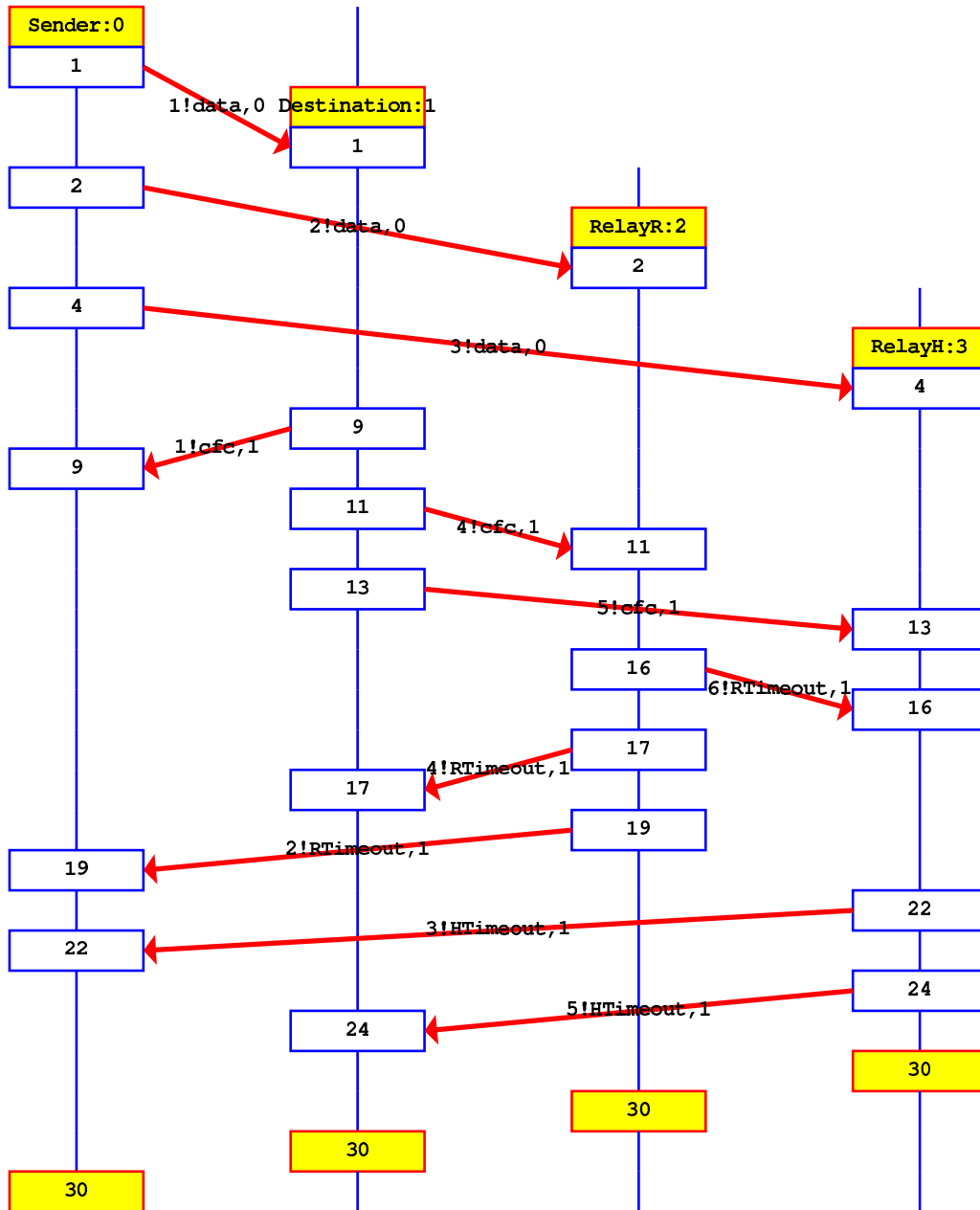

FIGURE C.12: Simulation Result for Case IVc: Cooperative Retransmission Fails: No Available Relay.

VI.B Never Claims

A straightforward verification of the protocol requirements can be modeled as never-claims using PROMELA. We formalize tasks that are claimed to be performed by the system using the LTL logic. SPIN can either prove or disprove those claims quickly.

In our model, we define the requirement for the C-ARQ protocol as: *If there exists a good data transmission link, either a source-destination link or a source-relay-destination link, the DATA packet should be successfully delivered from source to destination and the ACK packet should be returned to the source.* We formulate the LTL logic for this statement using *SDChannel*, *SRChannel*, *RDChannel*, *SHChannel*, *HDChannel* and *Transmission* as global mtype variables (See *LTL for Never Claim* below). They are introduced to indicate whether the corresponding channel condition is good (no data corruption) or not and whether the data transmission is successful or not.

```
[ ] ( (psd || (psr && prd) || (psh && phd) )
      -> <> q )

#define psd (SDChannel==good)
#define psr (SRChannel==good)
#define psh (SHChannel==good)
#define prd (RDChannel==good)
#define phd (HDChannel==good)
#define q (Transmission==good)
```

The verification results produced by the SPIN tool are depicted at the bottom of the *Verification output for Never Claim* chart. No errors occurred in the exhaustive verifications, indicating that the claim proposed holds for the C-ARQ protocol.

```
warning: for p.o. reduction to be valid
the never claim must be stutter-invariant
(never claims generated from LTL formula
are stutter-invariant)
depth 0: Claim reached state 5 line 336)
depth 50: Claim reached state 9(line 341)
depth 48: Claim reached state 9(line 341)
(Spin Version 5.2.5 - 17 April 2010)
+ Partial Order Reduction
Full statespace search for:
never claim +
assertion violations +
```



```

                (if within scope of claim)
acceptance    cycles +
                (fairness disabled)
invalid end states    -
                (disabled by never claim)
State-vector 116 byte, depth reached 365,
errors: 0
    3739 states, stored (3752 visited)
    931 states, matched
    4683 transitions    (= visited+matched)
    0 atomic steps
hash conflicts:    10 (resolved)

```

VII. DISCUSSIONS

The main contribution of this work is to verify the correctness of the C-ARQ model using simulations and verifications. We have demonstrated that C-ARQ as proposed is indeed correctly executed under various conditions.

To test the protocol using generic descriptions of node instead of specific roles (like sender, receiver or relay) would be overly complex and inefficient. The model can be simplified to a large extent by assigning roles to nodes during a single transaction where (in time) a node can be a sender or a receiver or a relay. The roles can be switched at a later transaction, but our model remains valid since they abstract the roles from the nodes themselves. This approach also enables us to clearly implement and analyze the role specific functions that are needed in this protocol.

To represent the correctness condition for the proposed C-ARQ protocol in LTL is a challenging task. For example, how do we relate the channel conditions (even with packet loss or data corruption) and check if the protocol can function in diverse channel conditions? We accomplish this by randomizing channel conditions in simulations and relating the fundamental conditions to the successful transmission of data. More specifically, the protocol should be able to deliver the data packet correctly if there has been a functional path (direct or indirect via relays) between the source and the destination. See Section VI.1 for the formulation of this condition.

The assumptions and constraints are essential in this verification procedure of the protocol. The verification we have undertaken is an “exhaustive state space mode” which is equivalent to an exhaustive proof of correctness (for the correctness conditions that were specified). In the ‘invalid end state’ verification (Sec VI.1), we make sure that the protocol never enters a state from which it cannot exit, i.e., avoiding infinite loops (like all nodes waiting for a packet that is never sent or get lost) or race conditions. Further versions of the protocol should satisfy these tests to be able to prove their correctness as well.

VIII. CONCLUSIONS

In this paper, we have described the C-ARQ MAC protocol with a formal SDL model, and used PROMELA along with the SPIN model checker to verify the correctness and the functionality of the protocol. Simulation results from SPIN coincide with the protocol description, and the verifications are carried out through never-claims, using the LTL logic in SPIN. No invalid end-states were found and the proposed claim holds true in the exhaustive verification operations, indicating the integrity and validity of the C-ARQ protocol.

Furthermore, the formal model can be refined with more logic to verify other functions of the protocol. With the basic logic implemented and verified in this paper, further modifications to the model should be straightforward.

Acknowledgments

The authors would like to thank Prof. Andreas Prinz and Prof. Vladimir A. Oleshchuk (both from the University of Agder, Norway) for their valuable feedback and insights in this work.

References

- [1] J. Cai, X. Shen, J.W. Mark, Semi-distributed user relaying algorithm for amplify-and-forward wireless relay networks, *IEEE Transactions on Wireless Communications* 7 (4) (2008) 1348-1357.
- [2] J.N. Laneman, D.N.C. Tse, G.W. Wornell, Cooperative diversity in wireless networks: efficient protocols and outage behavior. *IEEE Transactions on Information Theory* 50 (12) (2004) 3062-3080.
- [3] J. Alonso-Zarate, E. Kartsakli, C. Verikoukis, Persistent RCSMA: A MAC protocol for a distributed cooperative ARQ scheme in wireless networks. *EURASIP Journal on Advances in Signal Processing* (2008), doi:10.1155/2008/817401.
- [4] P. Liu, Z. Tao, S. Narayanan, T. Korakis, CoopMAC: A cooperative MAC for wireless LANs. *IEEE Journal on Selected Areas in Communications*, 25 (2) (2007) 340-354.
- [5] J.S. Pathmasuritharam, A. Das, A.K. Gupta, Efficient multirate relaying (EMR) MAC protocol for ad hoc networks. *Proceedings of IEEE ICC* (2005) 2947-2951.
- [6] X. He, F. Y. Li, A multi-relay cooperative automatic repeat request protocol in wireless networks. *Proceedings of IEEE ICC* (2010) 1-6.
- [7] G.J. Holzmann, The model checker SPIN. *IEEE Transactions on Software Engineering* 23 (5) (1997) 279-295.
- [8] E.M. Clarke, O. Grumberg, D. Peled (2000), *Model checking*. ISBN-13: 978-0-262-03270-4. The MIT Press.
- [9] IEEE 802 WG, Wireless LAN medium access control (MAC) and physical layer (PHY) specifications, IEEE 802.11 (1999).
- [10] F. de Renesse, A.H. Aghvami, Formal verification of ad-hoc routing protocols using SPIN model checker. *Proceedings of the 12th IEEE Mediterranean Electrotechnical Conference* 3 (3) (2004) 1177-1182.

-
- [11] V. A. Oleshchuk, Modeling, specification and verification of ad-hoc sensor networks using SPIN. *Computer Standards & Interfaces*, 28 (2) (2005) 159-165.
- [12] J.S. Segui, Demand access protocol design and validation with SPIN. *IEEE Aerospace Conference* (2008) 1-8.
- [13] B. Long, J. Dingel, T.C.N. Graham, Experience applying the SPIN model checker to an industrial telecommunications system. *Proceedings of the 30th ACM/IEEE International Conference on Software Engineering* (2008) 693-702.
- [14] J. Li, J. Li, Model checking the SET purchasing process protocol with SPIN. *Proceedings of the 5th International Conference on Wireless Communications, Networking and Mobile Computing* (2009) 1-4.
- [15] X. He, F.Y. Li, Cooperative MAC design in multi-hop wireless networks: part I: when source and destination are within the transmission range of each other". *Wireless Personal Communications* 57 (3) (2010) 339-350.
- [16] X. He, F.Y. Li, Optimization of the relay selection scheme in cooperative retransmission networks. *Proceedings of IEEE VTC* (2011) 1-6.
- [17] SPIN tool website, <http://www.spinroot.com>.
- [18] G.J. Holzmann, An analysis of bitstate hashing, *Formal Methods in System Design* 13 (3) (1998) 289-307.

**THROUGHPUT AND ENERGY EFFICIENCY
COMPARISON OF ONE-HOP, TWO-HOP, VIRTUAL
RELAY AND COOPERATIVE RETRANSMISSION
SCHEMES**

Title: Throughput and Energy Efficiency Comparison of One-hop, Two-hop, Virtual Relay and Cooperative Retransmission Schemes

Authors: **Xin He** and Frank Y. Li

Affiliation: Department of Information and Communication Technology, University of Agder, P. O. Box 509, N-4898 Grimstad, Norway

Conference: *European Wireless*, Lucca, Italy, April 2010.

Copyright: ©IEEE

Throughput and Energy Efficiency Comparison of One-hop, Two-hop, Virtual Relay and Cooperative Retransmission Schemes

Xin He and Frank Y. Li

Dept. of Information and Communication Technology,

University of Agder (UiA)

N-4898 Grimstad, Norway

Email: {xin.he; frank.li}@uia.no

Abstract — Two main types of approaches exist for implementing cooperative communications at the MAC layer: virtual-hop relay and cooperative retransmission. While the virtual-hop relay schemes employ relay nodes to forward packets when higher end-to-end throughput can be achieved compared with the direct transmission, the cooperative retransmission schemes use relays to retransmit data only after the direct transmission fails. However, the performance of these different approaches has not been compared in the literature, especially when energy efficiency is considered. In order to find out the best transmission scheme, this paper evaluates and compares the performance of the one-hop direct transmission, two-hop transmission, efficient multi-rate relaying, cooperative MAC and automatic cooperative retransmission schemes, in terms of throughput, packet delivery rate and energy efficiency in distributed wireless networks.

I. INTRODUCTION

Diversity has been extensively studied to mitigate fading effects resulted from multipath propagations in various transmission environments of wireless networks. Especially, spatial diversity in the context of multiple-input-multiple-output systems has attracted much attention in the past few years [1]. However, it may not be feasible to install multiple antennas on a wireless device due to size, cost or hardware limitations, and most current WLAN terminals in the market do not support multiple antennas yet. In such a context, cooperative communications have been proposed to achieve spatial diversity in a distributed way.

Cooperation communications have great potential for wireless ad hoc networking applications due to its terminal to terminal transmission mode. Since the wireless transmission intended for a particular destination station can be overheard by other neighboring stations, cooperative diversity can be achieved by requiring neighboring stations to forward their overheard information to the final destination. Many publications have come up with various approaches for implementing cooperative communications, and significant gains have been demonstrated in terms of capacity, throughput, network coverage and energy efficiency [2][3].

There are two main types of approaches in the literature for implementing cooperative communications at the MAC layer: virtual-hop relay and cooperative retransmission. In the virtual-hop relay solution, for instance [4] ~ [7], high data rate stations assist low data rate stations in their transmissions by forwarding their traffic. A helper node is selected beforehand to work as a virtual-hop node between the source and the destination. Each station selects either direct transmission or source-relay-destination transmission in order to minimize the total transmission time and hence the throughput bottleneck caused by low data rate stations is mitigated.

On the other hand, [8] ~ [9] have proposed cooperative retransmission schemes, which apply distributed automatic repeat request to achieve cooperative diversity in wireless networks. In these schemes, first the source node sends its data packet to its destination directly following the original protocol. The relay node will be selected to forward the packet to the destination only when the direct transmission fails.

This paper aims to compare the performance of the above mentioned two types of cooperative MAC schemes that appeared in the literature. Efficient Multi-rate Relaying (EMR) MAC [4] and Cooperative MAC (CoopMAC) [7] are taken as examples of the virtual-hop schemes and Automatic Cooperative Retransmission (ACR) MAC [10] as an example of the cooperative retransmission schemes respectively. In addition, adaptive Modulation and Coding Scheme (MCS) is introduced to every scheme to exploit the channel capacity more efficiently. The performance of the different schemes is evaluated in a simplified three-node model with Rayleigh fading channels and compared with each other in terms of throughput, packet delivery rate and energy efficiency.

The rest of the paper is organized as follows. The system model and assumptions are introduced in Sec. II. Different transmission schemes are described in Sec. III. A

multi-fold performance analysis is given in Sec. IV, and the simulation evaluations are presented in Sec. V. Finally a conclusion is drawn in Sec. VI.

II. SYSTEM MODEL AND ASSUMPTIONS

We consider a simple network for performance evaluation of the different schemes, as shown in Fig. D.1. The model consists of a source station, S, a destination station, D, and a helper (or relay) node, R.

Each packet transmission starts from S, with the intended destination as D. With one-hop transmission, the data packet is transmitted to D directly. With two-hop transmission, R works as an intermediate hop between S and D. In the virtual-hop schemes, R is employed as an intermediate relay node only when the source-relay-destination link provides better performance. In cooperative retransmission schemes, R will forward the packet from S to D when the direct transmission fails.

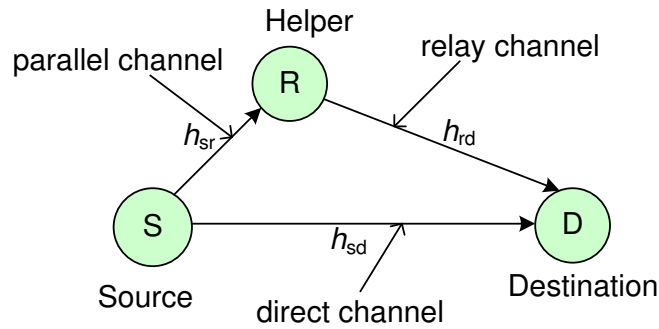

FIGURE D.1: A Three-node Network with Cooperative Communications.

A. Channel Assumption

For convenience, we name the channels between S and D, between S and R, and between R and D as *direct channel*, *parallel channel* and *relay channel* respectively. The channel fading on these channels is assumed to be independent of each other. We further assume constant channel fading during the whole packet transmission period, with h_0 , h_1 and h_2 representing the fading factor of the *direct*, *parallel* and *relay* channels, respectively.

B. Power Consumption

The power consumption in different modes is described as follows. A transmitting node consumes P_T power units during transmission, but only $P_T(1 - \alpha)$ is actually

generated for Radio-Frequency (RF) transmission power, where $(1 - \alpha)$ accounts for the efficiency of the RF power amplifier[11]. Any receiving node consumes P_R to receive the data. The power consumed in the idle state is neglected. The values of the parameters α , P_T and P_R are specified by the manufacturer and are assumed to be the same for all nodes in the network.

C. Received Signal Model

In this network, the signal received at D from S on the *direct* channel, at R from S on the *parallel* channel and at D from R on the *relay* channel are denoted as $y_i, i = 0, 1, 2$ respectively, and expressed in the following[12]:

$$y_i = \sqrt{P_T(1 - \alpha)d_i^{-\gamma}}h_i x_i + n_i, i = 0, 1, 2 \quad (1)$$

where $d_i, i = 0, 1, 2$ is the distance between S and D, between S and R, and between R and D, respectively; x_i is the transmitted signal on the above three channels respectively; $n_i, i = 0, 1, 2$ is the introduced Additive White Gaussian Noise (AWGN) noise signal correspondingly; and γ is the path loss exponent.

The Signal-to-Noise Ratio (SNR) of the received signals is calculated as follows, where N_0 is the spectral power density of the Gaussian white noise at the receiver and W is bandwidth in hertz available for transmission.

$$SNR_i = \frac{P_T(1 - \alpha) |h_i|^2}{d_i^\gamma N_0 W}. \quad (2)$$

D. MCS Selection

In our model, the transmission rate of the data packet is determined by the selected MCS scheme at the MAC layer according to the corresponding instantaneous channel condition. For instance, the channel condition between the transmitter and the receiver can be represented by the SNR value of the received signal at the receiver. By checking a threshold value, which is pre-determined to guarantee a certain bit error rate for each MCS scheme or to maximize the system throughput, an appropriate data rate is selected [13].

According to the instantaneous channel conditions of the *direct*, *parallel* and *relay* channels, which are represented by the measured SNR ratio from Eq. (2), the data rates R_{sd} , R_{sr} , R_{rd} are determined respectively for each channel. The required channel conditions are assumed to be obtained beforehand and the overhead is not considered in this study.

III. MAC SCHEME DESCRIPTION

In this section, the direct transmission, two-hop transmission, virtual-hop relay and cooperative retransmission schemes are described in details.

A. One-Hop Direct Transmission

The direct data transmission follows the IEEE 802.11 Distributed Coordination Function (DCF) protocol [14]. The retry limit is set to be 1 in our analysis, i.e., the source will not retransmit the data packet if the direct transmission fails.

The message procedure is shown in Fig. D.2. The source node listens to the channel for DCF InterFrame Space (DIFS) before it sends its data packet. A random backoff scheme is executed thereafter to avoid collision. If the destination node receives the data packet successfully, it returns an acknowledgment (ACK) frame after a Short InterFrame Space (SIFS) interval. The DATA and ACK packets are transmitted on the *direct* channel at the data rate R_{sd} . Note that ACK frame is transmitted at the same rate as the DATA packet.

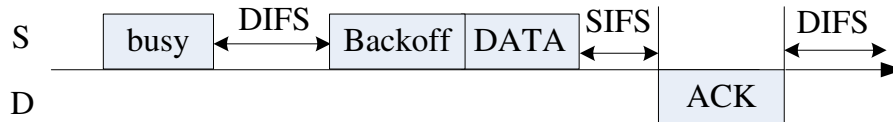

FIGURE D.2: Direct Transmission Scheme. The DATA and ACK Packets Are Transmitted at R_{sd} .

B. Traditional Two-Hop Transmission

In the two-hop transmission, R is an intermediate node between S and D. The data packet is first transmitted from S to R, then from R to D. Both S and R need to contend for channel access to transmit packets following the DCF protocol, as shown in Fig. D.2. The DATA and ACK packets in each hop are transmitted at the data rate, R_{sr} and R_{rd} , respectively.

C. Virtual-hop Relay

With the virtual-hop relay schemes, different protocols have different criteria to decide whether the source-relay-destination link provides better performance than the direct channel. For example, in the CoopMAC protocol [7], R is adopted to forward its data packet when:

$$\frac{1}{R_{sr}} + \frac{1}{R_{rd}} < \frac{1}{R_{sd}}. \quad (3)$$

In another example, EMR MAC, the relay link is selected when it can provide higher effective throughput. The effective throughput is obtained based on the assumption that no data corruption occurs neither in the source-relay-destination link nor in the source-destination link [4].

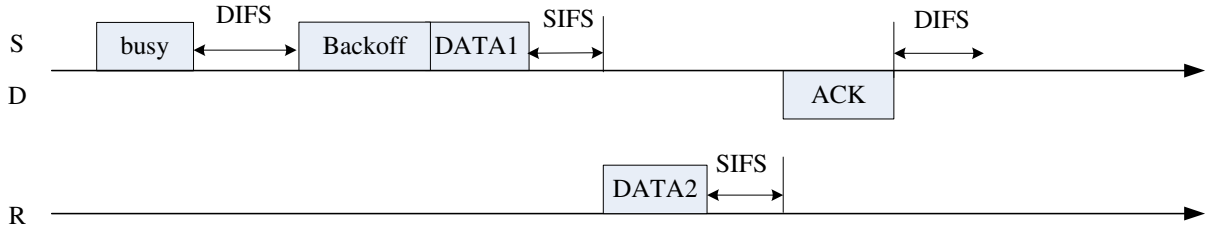

FIGURE D.3: Virtual-hop Relay Scheme. DATA1 at R_{sr} ; DATA2 at R_{rd} ; and ACK at R_{sd} .

For both CoopMAC and EMR MAC, if the relay node satisfies the requirement of cooperation, the data packet is first sent to R at R_{sr} , and then forwarded by R to the destination D at R_{rd} after SIFS, as shown in Fig. D.3. Different from other cooperative schemes, an ACK packet is returned back to S *directly* at R_{sd} if D decodes the packet correctly. Otherwise, if the relay link is not better than the direct link, the data transmission will be executed according to the original DCF protocol in Fig. D.2.

D. Cooperative Retransmission

As the first step of cooperative retransmission, node S sends out its data packet to D at R_{sr} according to the original DCF in 802.11. If the direct transmission succeeds, the message sequence will proceed exactly the same as the original scheme. Otherwise, if R has decoded its received data packet correctly, R will automatically forward the packet to D at R_{rd} after ACK timeout, without waiting for DIFS. If the cooperative transmission through R succeeds, an ACK will be sent to R at R_{rd} and then relayed to S

by R at R_{sr} in a two-hop manner, in order to guarantee a reliable transmission. If even the cooperative retransmission fails, S has to wait for a longer ACK timeout, which is twice of the sum of SIFS and ACK transmission time, to initiate the next transmission. The message sequences when the cooperative retransmission is executed successfully are illustrated in Fig. D.4.

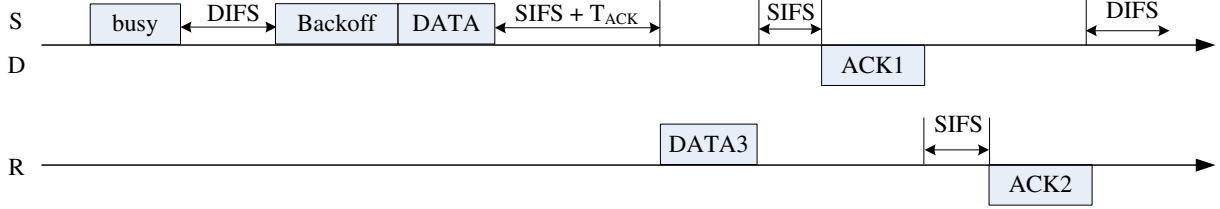

FIGURE D.4: Cooperative Retransmission Scheme. DATA at R_{sd} ; DATA3 at R_{rd} ; ACK1 at R_{rd} ; and ACK2 at R_{sr} .

IV. PERFORMANCE ANALYSIS

Packet Delivery Rate (PDR) at the MAC layer, normalized system saturation throughput, and energy consumption of the different schemes described in Sec. III are analyzed in this section.

A. One-Hop Direct Transmission Scheme

The PDR of the one-hop transmission scheme is the packet successful rate on the direct link.

$$PDR^a = 1 - p_{sd}, \quad (4)$$

where p_{sd} is the packet error rate on the *direct* channel, which is determined by the selected rate R_{sd} , the given packet length and the instantaneous channel condition.

The throughput performance can be obtained by calculating the average number of successfully transmitted payload information bits within average unit time consumed during the transmission:

$$\eta^a = \frac{PDR^a L}{\bar{\delta} + L/R_{sd} + L_{ACK}/R_{sd} + SIFS + DIFS}, \quad (5)$$

where L and L_{ACK} are the length of the DATA and ACK packets in bits respectively; and $\bar{\delta}$ is the average backoff time before each data transmission, which is half of the size of the minimal contention window multiplied by the duration of a slot time.

As mentioned in Sec. II, the energy consumed at an idle node is neglected. Therefore, the *total* energy consumed in the network for transmitting and receiving data packets is calculated as follows.

$$E^a = (P_T + P_R)(L/R_{sd} + (1 - p_{sd})L_{ACK}/R_{sd}). \quad (6)$$

B. Traditional Two-Hop Transmission Scheme

In the two-hop transmission, the data packet is received correctly at the destination node only if both the first hop transmission on the *parallel* channel and the second hop transmission on the *relay* channel are successful. Therefore, the PDR performance of the traditional two-hop transmission can be calculated as:

$$PDR^b = (1 - p_{sr})(1 - p_{rd}), \quad (7)$$

where p_{sr} and p_{rd} are the packet error rate on the *parallel* and *relay* channels respectively and can be determined accordingly by R_{sr} and R_{rd} in given channel conditions.

The throughput can be obtained in a similar way as in the direct transmission scheme:

$$\eta^b = \frac{PDR^b L}{D^b}, \quad (8)$$

where D^b is the time used for the two-hop transmission of the data packet and expressed as follows.

$$D^b = \bar{\delta} + L/R_{sr} + L_{ACK}/R_{sr} + SIFS + DIFS + (1 - p_{sr})(\bar{\delta} + SIFS + DIFS + L/R_{rd} + L_{ACK}/R_{rd}). \quad (9)$$

The *total* energy consumed during the data transmission in the network is calculated as follows.

$$E^b = (P_T + P_R)(L/R_{sr} + (1 - p_{sr})L_{ACK}/R_{sr}) + (P_T + P_R)(1 - p_{sr})(L/R_{rd} + (1 - p_{rd})L_{ACK}/R_{rd}), \quad (10)$$

where the two terms in the right side correspond to the first hop transmission and the second hop transmission respectively. The second hop transmission happens only when R decodes the data packet from S correctly.

C. Virtual-hop Relay Schemes

The performance analysis for both CoopMAC and EMR can be expressed in the same way. The only difference lies in their cooperation decision-making schemes. CoopMAC uses Eq. (7) to decide whether the relay node is adopted in data transmission while EMR chooses the path with higher effective throughput.

When the source-relay-destination link is chosen for data transmission, the PDR performance of the virtual-hop relay schemes, PDR_c , is the same as PDR_b in the two-hop transmission scheme. This is because the data packet is received correctly at the destination node only if both the transmissions on the *parallel* channel and on the *relay* channel are successful. Otherwise, PDR_c is the same as PDR_a in the direct transmission scheme.

$$PDR^c = \begin{cases} PDR^b & \text{if relay} \\ PDR^a & \text{otherwise.} \end{cases} \quad (11)$$

The throughput can be expressed correspondingly in two cases:

$$\eta^c = \begin{cases} PDR^b L / D^{CT} & \text{if relay} \\ T^a & \text{otherwise,} \end{cases} \quad (12)$$

where D^{CT} is the time used for the transmission of the data packet through the source-relay-destination link in the virtual-hop relay scheme.

$$D^{CT} = \bar{\delta} + L/R_{sr} + L/R_{rd} + L_{ACK}/R_{sd} + 2SIFS + DIFS. \quad (13)$$

The total energy consumed during the data transmission in the virtual-hop relay scheme is therefore expressed as follows.

$$E^c = \begin{cases} E^{CT} & \text{if relay} \\ E^a & \text{otherwise,} \end{cases} \quad (14)$$

where E^{CT} is the energy consumption when the relay node is adopted to forward data and expressed in the following.

$$E^{CT} = (P_T + P_R)L/R_{sr} + (P_T + P_R)(1 - p_{sr})L/R_{rd} + (P_T + P_R)(1 - p_{sr})(1 - p_{rd}^b)L_{ACK}/R_{sd}, \quad (15)$$

where the first two terms in the right side correspond to the DATA1 and DATA2 transmissions in Fig. D.3, respectively, and the last term accounts for the ACK transmission when D decodes the data packet successfully.

D. Cooperative Retransmission Scheme

In the cooperative transmission scheme in Fig. D.4, D receives the signal from S in the direct transmission phase with the data rate R_{sd} and the packet error rate p_{sd} . Meanwhile, the packet error rate on the *parallel* channel p_{sr}^c is determined by R_{sd} and the instantaneous *parallel* channel condition. The packet error rate p_{rd} on the *relay* channel in the cooperative retransmission phase can be obtained by R_{rd} in a similar way.

Based on the above information, the PDR of the cooperative retransmission scheme is the sum of the successful probability of the direct transmission and the successful probability of the cooperative retransmission, as expressed in the following.

$$PDR^d = (1 - p_{sd}) + p_{sd}(1 - p_{sr}^c)(1 - p_{rd}). \quad (16)$$

The throughput is derived based on the above information:

$$\eta^d = \frac{PDR^d L}{D^d}, \quad (17)$$

where D^d is the average time used for the whole transmission procedure in the cooperative retransmission scheme and is shown in the following.

$$D^d = \bar{\delta} + L/R_{sd} + L_{ACK}/R_{sd} + SIFS + DIFS + (L/R_{rd} + L_{ACK}/R_{rd} + L_{ACK}/R_{sr} + 2SIFS)p_{sd}(1 - p_{sr}^c). \quad (18)$$

The total energy assumed during the cooperative data transmission is calculated as:

$$E^d = (P_T + 2P_R)L/R_{sd} + (1 - p_{sd})L_{ACK}/R_{sd} + (P_T + P_R)p_{sd}(1 - p_{sr}^c)L/R_{rd} + (P_T + P_R)p_{sd}(1 - p_{sr}^c)(1 - p_{rd})(L_{ACK}/R_{rd} + L_{ACK}/R_{sr}), \quad (19)$$

where the first term in the right hand side corresponds to the direct DATA packet transmission; the second term corresponds to the ACK transmission when the direct transmission succeeds; the third term accounts for the cooperative DATA3 packet retransmission in Fig. D.4, which happens when R decodes the data packet from S correctly; and the last term accounts for the ACK transmission when D decodes the data packet successfully after the cooperative retransmission.

V. PERFORMANCE EVALUATION

The performance of the different schemes is evaluated and compared with each other through simulations in this section. The source node and the destination node are placed 50 m apart from each other (i.e., (-25 m, 0) and (25 m, 0) for the source and destination nodes respectively). Three topologies are investigated for performance comparison, as shown in Fig. D.5: 1) R is in the middle of S and D, (0, 5 m); 2) R is close to S, (-20 m, 5 m); 3) R is close to D, (20 m, 5 m). All the channels between each transmission pair are subject to independent Rayleigh fading.

The simulation parameters are listed in Table. D.1. The adopted MCS schemes and their corresponding threshold values of the received signal strength are shown in Table.

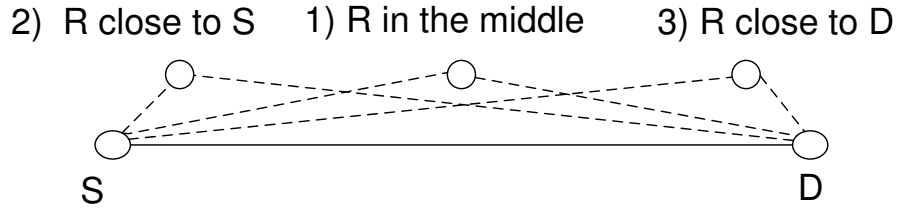

FIGURE D.5: Relay Topologies for Performance Comparison.

D.2. The threshold values are determined in order to achieve the highest throughput in given channel conditions. The path loss exponent γ is set to be 4.0 for indoor environments. The efficiency of RF power amplifier α is set to be 0.5. The power consumption for transmitting is set to be 1400 mW with 700 mW for RF transmission, and the power consumption for receiving is 900 mW [15].

TABLE D.1: Simulation Parameters.

| | |
|----------------|-----------------------|
| Payload length | 500 bytes or 50 bytes |
| MPDU header | 24 bytes |
| PHY header | 20 μ s |
| Basic datarate | 6 Mbps |
| RTS | 20 bytes |
| CTS | 14 bytes |
| CFR | 14 bytes |
| DIFS | 34 μ s |
| SIFS | 16 μ s |
| Slottime | 9 μ s |

TABLE D.2: Modulation and Coding Scheme Set.

| MCS Scheme | Data Rate | Threshold (500 B) | Threshold (50 B) |
|------------|-----------|-------------------|------------------|
| BPSK 1/2 | 6 Mbps | <3.2 dB | <2.2 dB |
| QPSK 3/4 | 18 Mbps | 3.2 dB ~ 4.8 dB | 2.2 dB ~ 3.8 dB |
| 16QAM 1/2 | 24 Mbps | 4.8 dB ~ 6.8 dB | 3.8 dB ~ 5.8 dB |
| 16QAM 3/4 | 36 Mbps | 6.8 dB ~ 10.2 dB | 5.8 dB ~ 9.2 dB |
| 64QAM 3/4 | 54 Mbps | >10.2 dB | >9.2 dB |

Moreover, E_t/N_0 is used to describe the channel conditions in our simulation environments, where E_t is the transmitted energy per bit at the transmitter and N_0 is the spectral power density of the Gaussian white noise at the receiver. The reason is that the transmitting power is fixed for all nodes in our simulations. The strength of the received

signal from a transmitting node that is closer to the destination is higher than from one far away from the receiver, resulting in different received SNRs from different transmitters at the receiver. Therefore, E_t/N_0 is a more sensible metric than E_b/N_0 to illustrate the performance of different schemes. That also explains why the range of the x-axis in the figures of this section seems to be unexpectedly high.

In the following subsections, simulations are made first with packet size of 500 bytes to investigate the protocol performance with different relay topologies, and then packet size of 50 bytes is adopted in the third subsection to investigate the protocol performance with small packets.

A. Topology 1: Relay in the Middle

The throughput performance of different schemes with the relay in the middle between S and D is shown in Fig. D.6. It is obvious that both the cooperative retransmission (ACR) and virtual-hop relay (EMR and CoopMAC) schemes have better performance than the direct one-hop transmission when the channel condition is poor and cooperation is necessary (125 dB \sim 155 dB in the E_t/N_0 field). In this figure, the throughput curves of EMR and CoopMAC collide with each other exactly, which indicates that the virtual-hop relay schemes are not sensitive to their cooperation requirements. ACR has inferior performance than the virtual-hop relay schemes because of its lower efficiency of utilizing channel capacity. We can also observe that two-hop transmission outperforms the direct transmission when E_t/N_0 is between 125 dB and 144 dB. It proves that with higher data rates adopted separately on the *parallel* channel and *relay* channels, higher throughput can be achieved in the two-hop transmission scheme.

Fig. D.7 depicts the PDR performance of the different schemes. We can observe from the figure that the packet delivery rate is improved by all the cooperative schemes compared with direct transmission. That is because that the relay node in the middle of source and destination provides more reliable link for data transmission. In this figure, EMR and CoopMAC show identical PDR performance, which is lower than the ACR and two-hop schemes. The reason is both EMR and CoopMAC are designed aiming at higher throughput instead of higher transmission reliability. The source-relay-destination link is chosen only when it can provide higher throughput, which results in that the relay

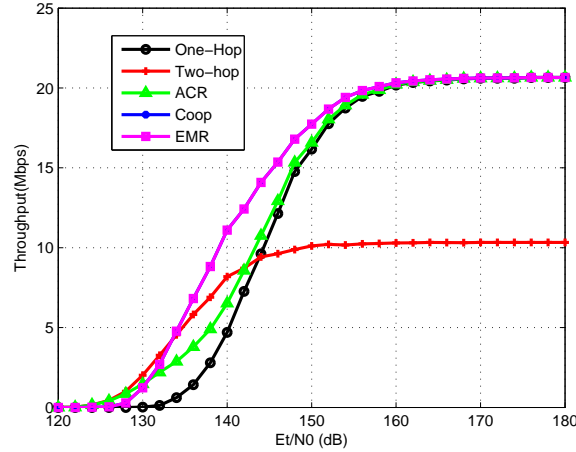

FIGURE D.6: Throughput Performance with Relay in the Middle.

node is not used as frequently as in the other schemes. Therefore, less packet delivery rate is provided in these two schemes.

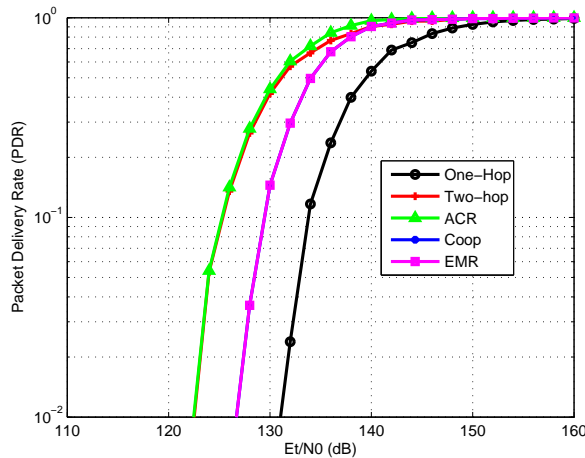

FIGURE D.7: Packet Delivery Rate with Relay in the Middle.

Furthermore, the energy consumption feature of the different schemes is shown in Fig. D.8. There are a couple of interesting observations in this figure. Firstly, ACR consumes most energy among all the schemes when E_t/N_0 is between 120 dB and 155 dB. This is because that the relay node in ACR needs to capture and decode the data packet from the source node every time, no matter if the retransmission is necessary or not. The peak value appears when E_t/N_0 is 130 dB, when cooperative retransmission is most likely executed and thus most transmitting power is consumed. When the

channel condition gets better, the energy consumption declines since fewer cooperative retransmissions are needed. In addition, ACR consumes more energy than the two-hop transmission scheme since it takes longer time for the relay node to receive the data packet from S. The reason is that the relay node in ACR captures the packet from the direct link at rate R_{sd} which is generally lower than the rate on the *parallel* channel R_{sr} adopted in the two-hop transmission schemes.

Secondly, the energy consumption curves of the two-hop and direct transmission schemes intersect with each other twice in Fig. D.8. More energy is consumed in two-hop transmission, when E_t/N_0 is lower than 132 dB. It is because that when the channel condition is poor, only very low data rate can be supported. Hence, the time used for data transmission cannot be saved in the two-hop transmission scheme but more energy is consumed at the intermediate node. Moreover, the intermediate node only transmits data to D when it has decoded the received packet from S successfully. That is why the peak value of two-hop transmission curve appears at 126 dB, when the second hop transmission from R to D most likely happens at a low data rate. With higher E_t/N_0 , higher data rate is adopted in *parallel* and *relay* channels in two-hop transmission and thus less time is consumed. Consequently, the energy consumption begins to drop. When E_t/N_0 is between 132 dB and 150 dB, the *parallel* and *relay* channels can adopt more efficient MCS schemes for higher data rate. Thus, much less transmission time is used in the combined two-hop link than the direct link and correspondingly less energy is consumed. When the channel condition gets even better (E_t/N_0 is above 150 dB), the direct link itself is efficient enough with high data rate. Both curves become flat afterwards when the highest data rate in the MCS set of the system has been adopted on all the three channels. Besides, the difference between these two curves is the extra energy cost for transmitting and receiving data at the intermediate node in the two-hop transmission mode.

Furthermore, we could also observe that CoopMAC and EMR consume even less energy than the direct transmission when E_t/N_0 is between 120 dB and 158 dB. The reason is that more efficient MCS schemes are adopted on both the *parallel* and *relay* channels, which results in less transmission time in total and thus less energy consumption.

Fig. D.9 illustrates the energy efficiency for information delivery of the different schemes. The energy efficiency is defined as the successfully delivered information bits

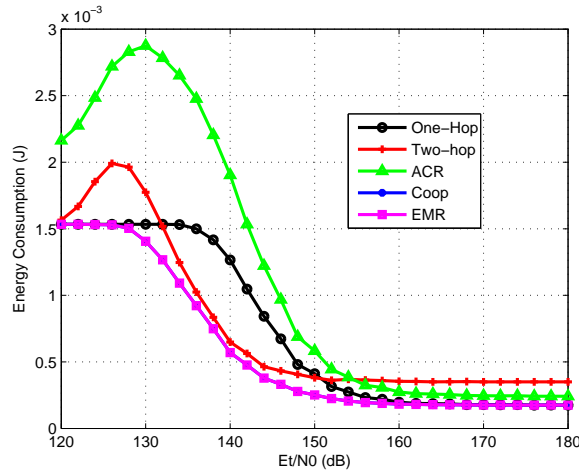

FIGURE D.8: Energy Consumption with Relay in the Middle.

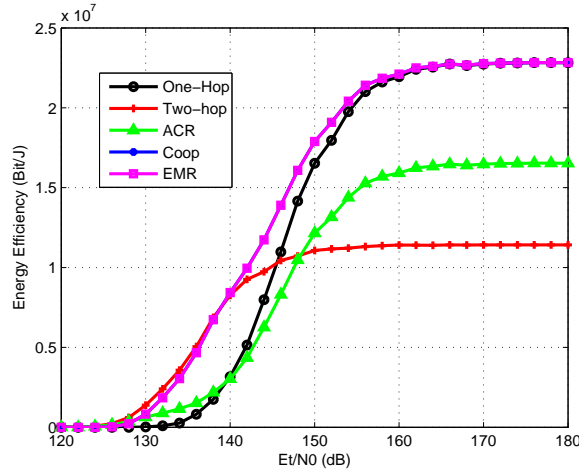

FIGURE D.9: Energy Efficiency with Relay in the Middle.

by each consumed joule of energy. It can be observed that EMR and CoopMAC have the highest energy efficiency. The ACR scheme is not as efficient as the virtual-hop schemes not only because the throughput performance is not as high but also more energy is consumed at the relay node. The two-hop scheme is best energy efficient when the channel condition is poor and gradually becomes the worst in good channel conditions. The reason is that when the channel condition is poor, the two-hop transmission can provide higher packet delivery ratio and hence higher throughput, at a cost of extra energy at the intermediate node. However, when the channel condition gets better, the intermediate relay node is made redundant in the data transmission, and the extra energy consumed decreases the energy efficiency of the scheme significantly.

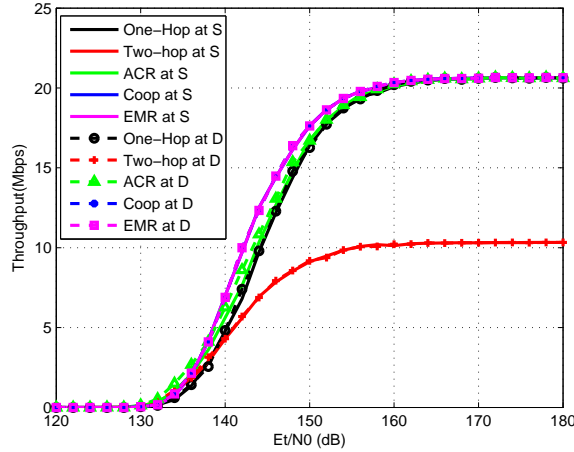

FIGURE D.10: Throughput Performance with Relay Close to Source or Destination.

B. Topologies 2, 3: Relay Close to Source or Destination

The throughput and reliability performance of the different schemes when the relay node is placed close to S or D is shown in Fig. D.10 and Fig. D.11, respectively. In those figures, we can see that the throughput and PDR curves from these two topologies collide with each other for each transmission scheme. The reason is that the wireless channels in these two cases are reciprocal. When R is close to S, the *parallel* channel provides a higher probability for a successful data transmission, but meanwhile the *relay* channel transmission has a higher probability to fail, and vice versa. Thus, the whole source-relay-destination link provides almost identical performance with these two symmetric topologies. Compared with Fig. D.6 and Fig. D.7, it is evident that the performance enhancement of the cooperative schemes is more evident when the relay node is placed in the middle between S and D. This is because that more reliable source-relay-destination link is provided when the relay node is placed in the middle.

Fig. D.12 depicts the energy consumption feature of the different schemes with the relay node located close to S or D. It can be observed that the energy consumed by the ACR, CoopMAC and two-hop schemes is much less when the relay node is placed close to destination where E_t/N_0 is between 120 dB and 140 dB. The reason is explained as follows. The relay node only forwards data to destination when it receives the packet correctly from S. When R is situated close to D and far away from S, the probability that R receives the packet successfully from S is much lower than when it is placed

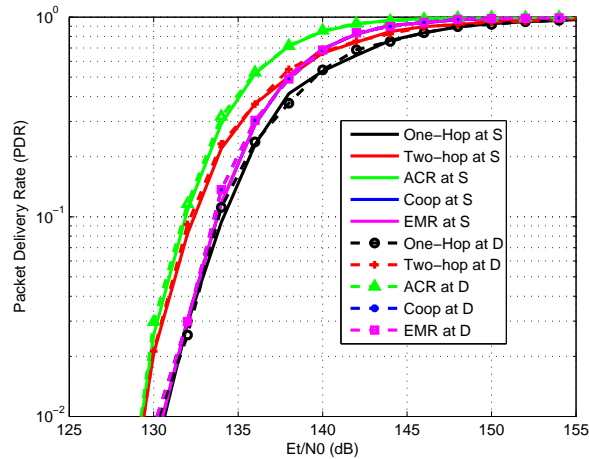

FIGURE D.11: Packet Delivery Rate with Relay Close to Source or Destination.

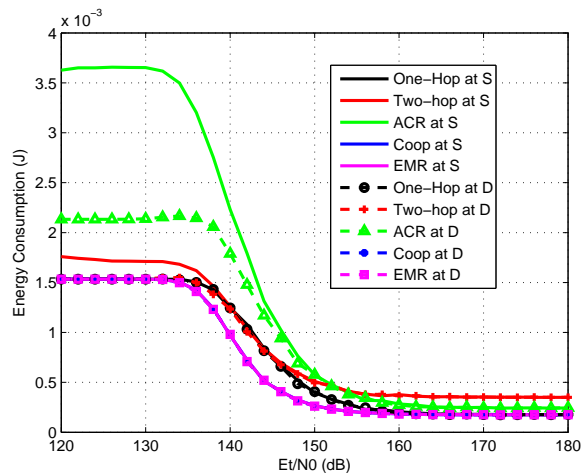

FIGURE D.12: Energy Consumption with Relay Close to Source or Destination.

close to S and far away from D. Therefore, fewer packets are forwarded through the relay node during the simulation of 1000 packet transmissions, resulting in less energy consumption.

Again, the energy consumption curves of CoopMAC and EMR with different topologies collide with each other in Fig. D.12. This is because in CoopMAC and EMR, whether to adopt the relay node for cooperative transmissions depends on whether the whole source-relay-destination link provides higher throughput. Since the two locations of R are symmetric between S and D, the energy consumption in these two schemes is not influenced by these two different network topologies.

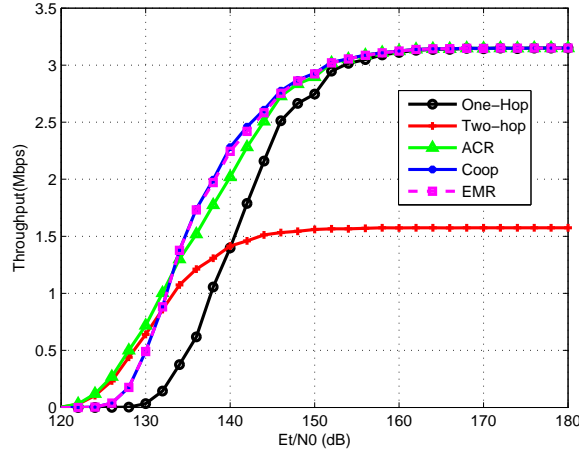

FIGURE D.13: Throughput Performance with 50-byte Packets.

C. Performance Comparison with Small Packet Size

In this subsection, the packets for simulations are set to be 50 bytes in order to investigate the impact of packet size on protocol performance. Figs. D.13-D.16 depict the throughput, PDR, energy consumption and energy efficiency features of different schemes respectively.

From those figures, we can conclude that the performance and energy consumption comparison results with 500-byte packet length hold true with small packets. Moreover, it can be observed that the throughput enhancement of the cooperative schemes becomes more evident when the packet size is small. ACR outperforms EMR and CoopMAC only when E_t/N_0 is between 120 dB and 134 dB due to its higher efficiency to exploit channel capacity with small packets in poor channel conditions and lower efficiency in good channel conditions. In Fig. D.16, the two-hop transmission becomes the most energy efficient scheme in poor channel conditions. Moreover, the energy consumption of all these schemes is less efficient than the large packet case due to relatively larger protocol overhead.

VI. CONCLUSIONS

In this paper, the performance of one-hop, two-hop, virtual-hop relay (EMR and CoopMAC) and cooperative retransmission (ACR) schemes has been evaluated and compared with each other in terms of throughput, packet delivery rate and energy consumption.

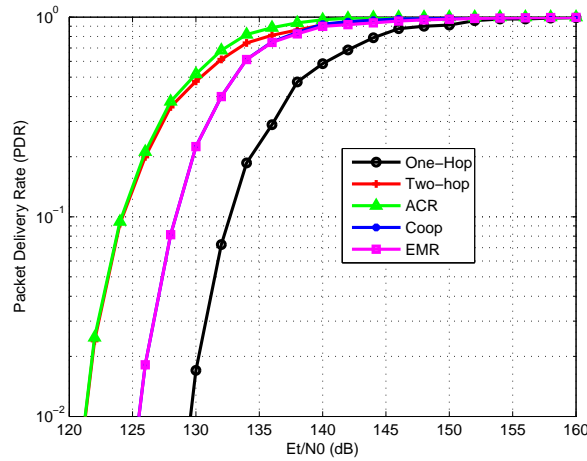

FIGURE D.14: Packet Delivery Rate with 50-byte Packets.

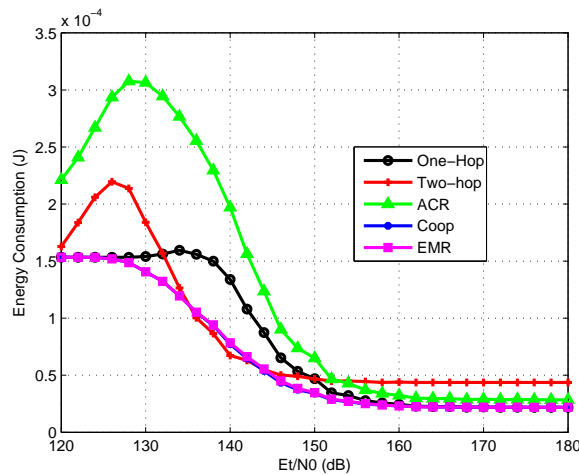

FIGURE D.15: Energy Consumption with 50-byte Packets.

The obtained simulation results show that ACR outperforms the other schemes in PDR performance at a cost of higher energy consumption. CoopMAC and EMR are successful with throughput enhancement, and meanwhile they are the most energy efficient schemes. Furthermore, the performance curves of EMR and CoopMAC collide with each other, indicating that the virtual-hop relay schemes are not sensitive to their cooperation requirements.

Moreover, the impact of the relay node placement is also investigated. The relay node when placed in the middle of source and destination can provide higher throughput and PDR performance for all the cooperative schemes. The relay node that is placed close to

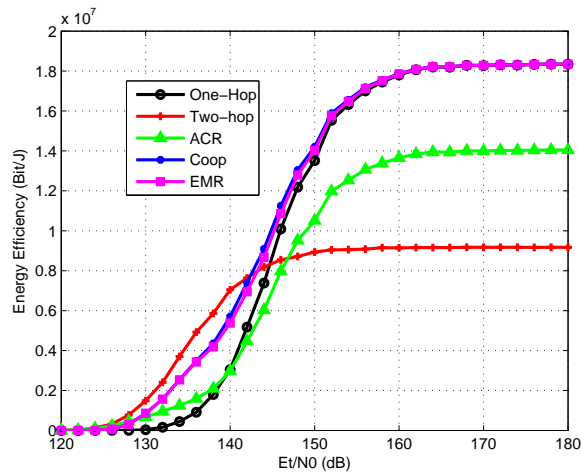

FIGURE D.16: Energy Efficiency with 50-byte Packets.

source or destination provides almost the same throughput and PDR performance, but it is more energy efficient when the relay node is located close to destination.

References

- [1] G. J. Foschini and M. Gans, "On the Limits of Wireless Communication in a Fading Environment When Using Multiple Antennas", *Wireless Personal Communications*, Vol. 6, No. 3, pp. 311-335, Mar. 1998.
- [2] A. Sendonaris, E. Erkip and B. Aazhang, "User Cooperation Diversity-Part I: System Description", *IEEE Trans. Comm.*, Vol. 51, No. 11, pp. 1927-1938, Nov. 2003.
- [3] A. Sendonaris, E. Erkip and B. Aazhang, "User Cooperation Diversity-Part II: Implementation Aspects and Performance Analysis", *IEEE Trans. Comm.*, Vol. 51, No. 11, pp. 1939-1948, Nov. 2003.
- [4] J. S. Pathmasuritharam, A. Das, and A. K. Gupta, "Efficient Multi-rate Relaying (EMR) MAC Protocol for Ad Hoc Networks", in *Proc. of IEEE ICC 2005*, Singapore, May 2005.
- [5] C. Chou, J. Yang and D. Wang, "Cooperative MAC Protocol with Automatic Relay Selection in Distributed Wireless Networks", in *Proc. of IEEE PerComW*, NY, USA, Mar. 2007.

- [6] H. Shan, P. Wang, W. Zhuang and Z. Wang, "Cross-layer Cooperative Triple Busy Tone Multiple Access for Wireless Networks", in Proc. of IEEE GLOBECOM, New Orleans, LO, USA, Nov. 2008.
- [7] P. Liu, Z. Tao, S. Narayanan, T. Korakis and S. Panwar, "CoopMAC: A Cooperative MAC for Wireless LANs", IEEE JSAC, Vol. 25, No. 2, pp. 340-354, Feb. 2007.
- [8] M. Dianati, X. Ling, K. Naik and X. Shen, "A Node-cooperative ARQ Scheme for Wireless Ad Hoc Networks", IEEE Trans. Comm., Vol. 55, No. 3, pp.1032-1044, May 2006.
- [9] J. Alonso-Zarate, E. Kartsakli, Ch. Verikoukis, and L. Alonso, "Persistent RC-SMA: A MAC Protocol for a Distributed Cooperative ARQ Scheme in Wireless Networks", EURASIP Journal on Advances in Signal Processing, Vol. 2008, 2008, doi:10.1155/2008/817401.
- [10] X. He and F. Y. Li, "An Automatic Cooperative Retransmission MAC protocol in Wireless Local Area Network", in Proc. of European Wireless, Aalborg, Denmark, May 2009.
- [11] A. K. Sadek, W. Yu and K. J. R. Liu, "When Does Cooperation Have Better Performance in Sensor Networks?", in Proc. of IEEE SECON, Reston, VA, USA, Sept. 2006.
- [12] C. A. Balanis, "Antenna Theory", John Wiley and Sons Inc., 2003.
- [13] X. He, F. Y. Li and J. Lin, "Link Adaptation with Combined Optimal Frame Size and Rate Selection in Error-prone 802.11n Networks", in Proc. of IEEE ISWCS, Reykjavik, Iceland, Oct., 2008.
- [14] IEEE 802 WG, "Wireless LAN Medium Access Control (MAC) and Physical Layer (PHY) Specifications" IEEE 802.11std, 1999.
- [15] I. Ebert, S. Aier, G. Kofahl, A. Becker, B. Bums, and A. Wolisz, "Measurement and Simulation of the Energy Consumption of a WLAN Interface" Tech. Rep. TKN-02-010, Technical University Berlin, Telecommunication Networks Group, Germany, June 2002.

METRIC-BASED COOPERATIVE ROUTING IN MULTI-HOP AD HOC NETWORKS

Title: Metric-based Cooperative Routing in Multi-hop Ad Hoc Networks

Authors: Xin He and Frank Y. Li

Affiliation: Department of Information and Communication Technology, University of Agder, P. O. Box 509, N-4898 Grimstad, Norway

Journal: *Journal of Computer Networks and Communications, Hindawi*, accepted in Jan. 2012.

Copyright: ©Hindawi

Metric-based Cooperative Routing in Multi-hop Ad Hoc Networks

Xin He and Frank Y. Li

Dept. of Information and Communication Technology,

University of Agder (UiA)

N-4898 Grimstad, Norway

Email: {xin.he; frank.li}@uia.no

Abstract — Cooperative communication fully leverages the broadcast nature of wireless channels and exploits time/spatial diversity in a distributed manner, thereby achieving significant improvements in system capacity and transmission reliability. Cooperative diversity has been well studied from the physical layer perspective. Thereafter, cooperative MAC design has also drawn much attention recently. However, very little work has addressed cooperation at the routing layer. In this paper, we propose a simple yet efficient scheme for cooperative routing by using cooperative metrics including packet delivery ratio, throughput and energy consumption efficiency.

To make a routing decision based on our scheme, a node needs to first determine whether cooperation on each link is necessary or not, and if necessary, select the optimal cooperative scheme as well as the optimal relay. To do so, we calculate and compare cooperative routing metric values for each potential relay for each different cooperative MAC scheme (C-ARQ and CoopMAC in this study), and further choose the best value and compare it with the non-cooperative link metric. Using the final optimal metric value instead of the traditional metric value at the routing layer, new optimal paths are set up in multi-hop ad hoc networks, by taking into account the cooperative benefits from the MAC layer. The network performance of the cooperative routing solution is demonstrated using a simple network topology.

I. INTRODUCTION

Multi-hop wireless networks in forms of ad hoc networks, mesh networks and sensor networks have become active research topics in recent years both in academia and industry. Different types of nodes are deployed pervasively in various environments such as office buildings, wildlife reserves, battle fields and metropolitan area networks. However,

lots of challenging tasks still remain for building multi-hop ad hoc networks, despite significant progress achieved so far.

Traditional techniques conceived for wired networking provide inefficient performance when applied in wireless ad hoc networks. Efforts are being made to improve the existing techniques and protocols with new features suitable for the wireless paradigms. For example, different from wired transmission, broadcast is an inherent feature in wireless communications, i.e., information transmitted from a source node can be overheard by not only the destination node, but also neighboring nodes surrounding the source. In traditional wireless networks, signals received by the neighboring nodes are treated as interference and many techniques have been developed to alleviate its effect. However, such signals actually contain useful information for the destination node. In fact, if the information can be properly forwarded by the surrounding node(s), the reception performance at the destination can be improved. This fact motivates the application of a new technology, known as *cooperative communication* [1].

The theory behind cooperation communication has been studied in depth [2]. Different approaches can be used at the physical layer to exploit cooperative diversity such as *Store-and-Forward (S&F)*, *Amplify-and-Forward (A&F)*, *Decode-and-Forward (D&F)*, *Coded Cooperation (CC)* and so on [3]-[5]. Significant improvements of system performance have been demonstrated in terms of parameters such as outage probability, coverage extension and energy efficiency. Recently, cooperative Medium Access Control (MAC) design in distributed wireless networks has also attracted much attention [6]-[8]. Based on Carrier Sense Multiple Access with Collision Avoidance (CSMA/CA), there are mainly two categories of cooperative MAC protocols proposed in the literature: *Virtual Hop Cooperative MAC* and *Cooperative Automatic Repeat reQuest*, with *CoopMAC* [10] and *C-ARQ* [9] as typical examples in each family.

Although significant efforts have been made on the physical layer and MAC layer issues of cooperative communications, there has been very little work so far on the cross-layer design of cooperative systems, especially how to combine cooperation with routing. While some of the studies focused on the theoretical analysis on routing and cooperative diversity [11], other work, [12], addressed the joint optimization of routing and power allocation. [14] calculated the theoretical optimal route of a cooperative network

based on the assumption of simultaneous channel access of multiple nodes. However, this assumption is not realistic for devices currently used in wireless networks.

Apart from designing a brand new cross-layer cooperative routing protocol, an alternative way to extend cooperative communications to routing layer is to design routing metrics that reflect potential cooperation gain, and find optimal paths using the new cooperative metrics. [15] proposed a routing metric solution for a given cooperative network model. In their model, each node or each link is assumed to have a selected relay. However, as pointed out in [13], relay selection with low overhead is a challenging task in cooperative transmissions. [16] introduced a routing metric, termed Cooperative Expected Transmission Time (CETT), which may be adopted in multi-hop networks with a suitable cooperative MAC mechanism. CETT is defined as the estimated frame transmission time over one single hop, considering the presence of potential relay nodes within its reach.

As a contribution to this direction, this paper proposes a cross-layer cooperative scheme by using various cooperative metrics instead of traditional routing metrics to exploit cooperative diversity at the routing layer. To perform the scheme, a new cooperative metric is calculated for each potential relay and every individual cooperative transmission scheme for each link beforehand. Then, by comparing the obtained best cooperative link metric with the traditional non-cooperative link metric, a node decides whether cooperative retransmission on each link needs to be initiated or not. By choosing the best among all these calculated metrics, the optimal relay node as well as the optimal MAC scheme are selected for each link. Finally, the optimal path from source to destination is established through routing algorithms using the new optimal link metrics. In this way, the potential cooperative benefit from the MAC layer is exploited at the routing layer.

The studied metrics include Packet Delivery Ratio (PDR), throughput, and energy efficiency, considering different requirements in various network scenarios. The proposed routing algorithm is implemented and evaluated using a simple topology to demonstrate the performance improvement by the proposed cooperative routing scheme.

The rest of the paper is organized as follows. The cross-layer cooperative network is introduced in Sec. II. The derivation of different routing metrics is given in Sec. III, while the routing algorithm is outlined in Sec. IV. In Sec. V, the performance is evaluated through simulations. Finally, the paper is concluded in Sec. VI.

II. CROSS LAYER COOPERATIVE NETWORKING

The cross-layer cooperative networking system considered in our study involves the physical layer, the MAC layer as well as the routing layer. In this section, the network model is introduced first, and then the average packet error rate of the data transmission is derived. In the second subsection, we summarize the principles of the two *existing* cooperative MAC mechanisms which constitute the layer 2 basis for our routing algorithms. In the third subsection, how cooperative benefits are exploited at the routing layer using the MAC layer information is explained.

A. Signal-to-Noise Ratio and Packet Error Rate (Physical Layer)

We start our description from an introduction of power consumption of a communication system in different modes. A transmitting node consumes P_T amount of power during transmission, but only $P_T(1 - \alpha)$ is actually generated for Radio-Frequency (RF) transmission power, where $(1 - \alpha)$ accounts for the efficiency of the RF power amplifier. Any receiving node consumes P_R amount of power to receive data. The power consumed in the idle state is neglected. The concrete values of the parameters, α , P_T and P_R are specified by the manufacturer and are assumed to be the same for all nodes in the network.

Thus, the signal received at a transmitter which is d distance away from the transmitter, can be expressed as follows:

$$y(t) = \sqrt{P_T(1 - \alpha)d^{-\tau}}h(t)x(t) + n(t) \quad (1)$$

where $x(t)$ is the transmitted signal; $n(t)$ is the system noise; $h(t)$ is the corresponding channel attenuation factor; and τ is the path loss exponent.

The average Signal-to-Noise Ratio (SNR) of the received signal, $\bar{\gamma}$, is expressed as follows, where N_0 is the spectral power density of the Gaussian white noise at the receiver and W is bandwidth of the transmission in Hertz.

$$\bar{\gamma} = \frac{P_T(1 - \alpha) |h(t)|^2}{d_i^\tau N_0 W}. \quad (2)$$

Rayleigh fading is assumed in our channel model, but our analysis can be extended to other fading channels such as Rician or Nakagami. In order to simplify higher layer implementation, we obtain the average Packet Error Rate (PER) performance through analysis. The instantaneous SNR at the receiver through a Rayleigh fading channel has an exponential distribution as:

$$f(\gamma) = 1/\bar{\gamma}e^{-\gamma/\bar{\gamma}}. \quad (3)$$

We rely on the following expression to approximate PER over Additive White Gaussian Noise (AWGN) [17]:

$$PER_n(\gamma) \approx \begin{cases} 1, & \text{if } \gamma \leq \gamma_n^{th} \\ \beta_n e^{-\kappa_n \gamma}, & \text{if } \gamma > \gamma_n^{th} \end{cases} \quad (4)$$

where n is the Modulation and Coding Scheme (MCS) index, and γ is the SNR value at the receiver. Parameters β_n , κ_n and γ_n^{th} are dependent on the specific MCS scheme and data packet length. The appropriate values of these parameters are obtained by fitting Eq. (5) into the exact PER values through simulations. The tuning process is explained in details in the appendix, where the accuracy of this PER approximation is also verified [17].

Given an average SNR value, the PER performance averaged over Rayleigh fading is given as:

$$\begin{aligned} \overline{PER}(\bar{\gamma}) &= \int_0^{\infty} PER(\gamma) f(\gamma) d\gamma \\ &= \frac{\beta_n}{1 + \kappa_n \bar{\gamma}} e^{-\gamma_n^{th}(\kappa_n + 1/\bar{\gamma})} + \left(1 - e^{-\gamma_n^{th}/\bar{\gamma}}\right). \end{aligned} \quad (5)$$

In the case of Adaptive Coding and Modulation (ACM), the MCS scheme at the physical layer is determined according to the given channel condition. For instance, the channel condition between the transmitter and the receiver can be represented by the SNR value of the received signal. By checking a threshold value, an appropriate data

rate is selected [18]. In this case, the average PER can be expressed as:

$$\begin{aligned}
\overline{PER}^* (\bar{\gamma}) &= \sum_n \int_{\gamma_n^{dw}}^{\gamma_n^{up}} PER_n(\gamma) f(\gamma) d\gamma \\
&= \int_{\gamma_1^{dw}}^{\gamma_1^{up}} PER_1(\gamma) f(\gamma) d\gamma + \int_{\gamma_2^{dw}}^{\gamma_2^{up}} PER_1(\gamma) f(\gamma) d\gamma + \dots \\
&\quad + \int_{\gamma_n^{dw}}^{\gamma_n^{up}} PER_n(\gamma) f(\gamma) d\gamma \tag{6} \\
&= \sum_n \left[\frac{\beta_n}{1 + \kappa_n \bar{\gamma}} \left(e^{-\gamma_n^{dw} (\kappa_n + 1/\bar{\gamma})} - e^{-\gamma_n^{up} (\kappa_n + 1/\bar{\gamma})} \right) \right. \\
&\quad \left. + \left(e^{-\gamma_n^{dw}/\bar{\gamma}} - e^{-\gamma_n^{up}/\bar{\gamma}} \right) \right],
\end{aligned}$$

where γ_n^{up} and γ_n^{dw} are the upper bound and the lower bound of the SNR values respectively, when the MCS scheme with index n is adopted. The values of γ_n^{up} and γ_n^{dw} are predetermined for a given certain bit error rate for each MCS scheme or to maximize system throughput.

Based on the above information, the PER between each transmission pair can be calculated. After that, the PDR values, i.e., the percentage numbers of packet successfully delivered among all the packets at the MAC layer, can easily be obtained using $PDR = 1 - \overline{PER}$ (or \overline{PER}^*) on each link. These PDR values will be used later to calculate different metrics with different MAC schemes for cooperative routing.

Note that the packet delivery ratio on each link can also be obtained at the MAC layer by counting the percentage of packets that are acknowledged by ACK messages from the receiver. However for simplification and feasibility reasons, the PDR values in this study are calculated according to the physical layer abstraction procedure described above.

B. Cooperative MAC Mechanisms (MAC Layer)

As mentioned earlier, there exist two typical categories of cooperative MAC in the literature: namely *virtual-hop cooperative MAC* and *cooperative retransmission MAC*. In this study, we select one example from each category as the constituent MAC mechanism for our routing scheme.

a. Virtual-hop Cooperative MAC: CoopMAC

In *CoopMAC* [10], high data rate nodes are employed to transmit data in a two-hop manner instead of one-hop direct transmission with low data rate in order to avoid the throughput bottleneck caused by low data rate nodes. With this virtual-hop CoopMAC mechanism, a relay is adopted to forward its data packet when:

$$\frac{1}{R_{sr}} + \frac{1}{R_{rd}} < \frac{1}{R_{sd}}, \quad (7)$$

where R_{sd} , R_{sr} are R_{rd} the selected data transmission rates (determined by MCS schemes) on the channels from the sender to the one hop destination, from the sender to the relay node, and from the relay node to the one-hop destination respectively.

If the relay node is chosen in CoopMAC, the data packet is first sent to the relay at R_{sr} , and then forwarded by the relay to the destination at R_{rd} after a Short InterFrame Space (SIFS) interval, as shown in Fig. E.1. An ACK packet is returned back to the sender (S) *directly* at R_{sd} if the destination (D) decodes the packet correctly. Otherwise, if the relay link is not better than the direct link, the data transmission will be executed according to the original Distributed Coordination Function (DCF) protocol[19].

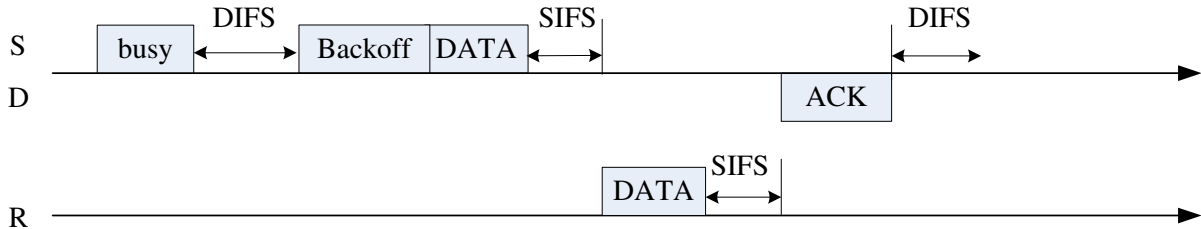

FIGURE E.1: CoopMAC: Virtual-hop Relay Scheme.

b. Cooperative Retransmission MAC: C-ARQ

As the first step in *C-ARQ* [9], node S sends out its data packet to D at R_{sr} following the original DCF protocol. If the direct transmission succeeds, the message sequence will proceed exactly the same as specified in DCF. Otherwise, when the direct transmission fails, if R has decoded its received data packet correctly, it will automatically forward the packet to D at R_{rd} after ACK timeout, without waiting for a DCF InterFrame Space (DIFS) interval. If the cooperative transmission through R succeeds, an ACK will be sent to R at R_{rd} and then relayed to S by R at R_{sr} in a two-hop manner, in order to guarantee a reliable transmission. If even the cooperative retransmission fails, S has to wait for a

longer ACK timeout, which is twice of the sum of SIFS and ACK transmission time, to initiate a new round of transmission.

The message sequences when the cooperative retransmission is executed successfully are illustrated in Fig. E.2.

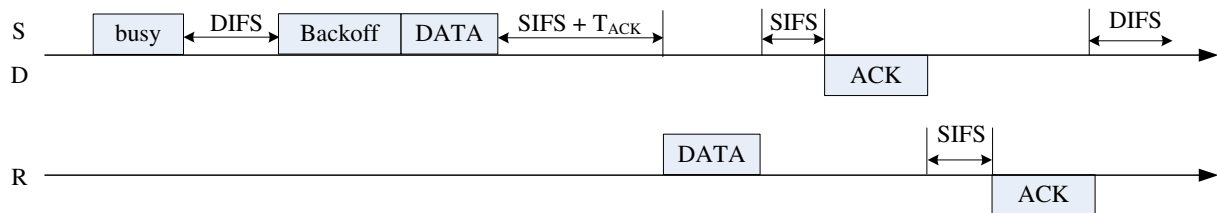

FIGURE E.2: C-ARQ: Cooperative Retransmission Scheme.

C. Routing with Cooperative Metrics (Routing Layer)

To operate a multi-hop ad hoc network, cooperative MAC mechanism itself is not sufficient. A smart routing protocol is needed for path establishment from source to destination.

Different from traditional routing decision, the best route selected by our routing scheme needs to take cooperative gains which are obtained from the underlying MAC layer into consideration. Cooperative routing is enabled when potential cooperation gain exists in comparison with traditional routing.

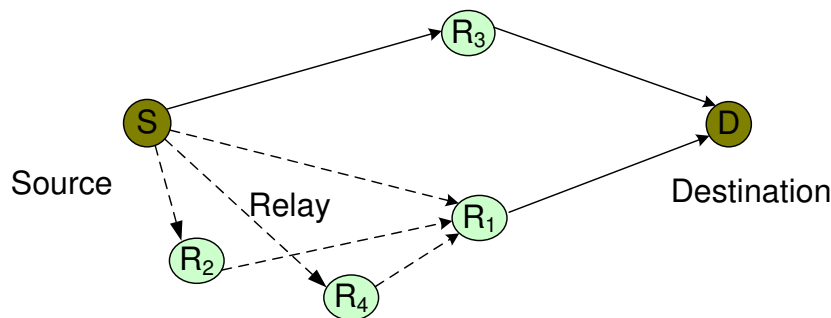

FIGURE E.3: Topology to Illustrate Cooperative Routing.

A very simple topology in Fig. E.3 is used here to explain how the proposed cooperative routing scheme works. In this network, both S and D can hear R_1 and R_3 but cannot hear each other. R_2 and R_4 can hear S and R_1 , but cannot hear the other nodes. When traditional routing is used, the routing metric is calculated for each link between any node pair which can hear each other. The possible paths for traffic from S to D will

have four alternatives: (1) $S \rightarrow R_1 \rightarrow D$; (2) $S \rightarrow R_3 \rightarrow D$; (3) $S \rightarrow R_2 \rightarrow R_1 \rightarrow D$; or (4) $S \rightarrow R_4 \rightarrow R_1 \rightarrow D$. Here, we assume that link $S \rightarrow R_3 \rightarrow D$ has better link quality and therefore is selected as the best route by traditional routing.

When cooperative communications are introduced into this network, R_2 or R_4 can function as a relay node between S and R_1 . In this way, the link quality between S and R_1 is upgraded when cooperative transmission is applied. As a result, path $S \rightarrow R_1 \rightarrow D$ may surpass path $S \rightarrow R_3 \rightarrow D$ and becomes the best route between S and D , as explained below.

First, the cooperative link metric needs to be calculated for each cooperative MAC scheme for each relay candidate. With two different MAC (*CoopMAC* and *C-ARQ*) and two relay candidates (R_2 and R_4), we have four cooperative routing metrics for this link between S and R_1 . Choosing the best metric among these four alternatives, both the optimal relay and the optimal MAC scheme (e.g., R_4 with *C-ARQ*) are selected. Thereafter, the obtained best value is compared with the non-cooperative link information metric. If the best cooperative link metric is superior to the non-cooperative link metric, cooperative MAC is adopted for data transmission over the link from S to R_1 , and the link metric from S to R_1 is updated to the best cooperative routing metric. With the new metric in routing algorithms, $S \rightarrow R_1 \rightarrow D$, using R_4 as a relay with *C-ARQ* for the link between S and R_1 , is selected to be the working path instead of $S \rightarrow R_3 \rightarrow D$. Better network performance can be achieved using the new path with cooperative transmissions. On the other hand, if the best cooperative link metric is inferior to the original non-cooperative link metric, the link metric remains the same, i.e., $S \rightarrow R_3 \rightarrow D$ as the working path.

In summary, with cooperative routing, not only the best path for data transmission is selected, but also the best cooperative MAC scheme as well as the best relay candidate are chosen. Different paths with different cooperative schemes and relays will be selected according to network requirements through different metrics from the MAC layer to the routing layer. Note that within a one-hop transmission link (i.e., a pair of source and destination nodes together with their neighboring nodes), the source node decides the transmission scheme and which relay to cooperate with. Thereafter, the neighboring nodes can be notified with this decision through the MAC header of the packet sent from the source node.

III. CROSS LAYER ROUTING METRIC

As mentioned in the preceding section, various metrics will be used for routing decision making in multi-hop networks. In this section, we will explain how to calculate these link metrics with different underlying cooperative MAC mechanisms.

The study is carried out considering different network performance parameters, such as packet delivery ratio, throughput and energy efficiency. Denote m as the index of an optional routing *path* in a graph, j as the index of a *link* along a whole path, and i as the index of a *relay* over a link. In cooperative link j , the sender u , the receiver v and the relay candidates $N_i, i = 1, 2, \dots, \xi_j$ are considered, where ξ_j is the number of available relays on link j . Use the topology in Fig. E.3 as an example. Along the optional path $S \rightarrow R_1 \rightarrow D$ ($m = 2$), in the first link $S \rightarrow R_1$ ($j = 1$), S is u ; R_1 is v ; ξ_j is 2; R_3 and R_4 are referred to as N_1 and N_2 respectively, according to the naming rules in this section.

The data rates used on the links from u to v , from u to N_i , and from N_i to v are denoted as R_{uv} , R_{ui} and R_{iv} respectively. Accordingly, the packet successful transmission rates on each channel are denoted as PDR_{uv} , PDR_{ui} and PDR_{iv} respectively. These packet successful transmission rate values are determined by the selected data rate over the link, given packet length and channel condition. In our simulations, the PDR values are obtained from physical layer analysis, as explained in Subsec. 2.1.

A. Packet Delivery Ratio

Packet delivery ratio at the MAC layer is used as an indicator for link reliability in this study. The PDR of the one-hop *direct* transmission scheme is the packet successful transmission ratio on the non-cooperative direct link, as:

$$PDR_{j,m}^{dcf} = PDR_{uv}, \quad (8)$$

where PDR_{uv} is the success probability of data transmission on the direct channel from sender to receiver.

In *CoopMAC*, if the relay link is chosen for data transmission, the PDR performance, PDR_{Coop} , is the probability that the transmissions both from u to relay i and from relay i to v are successful. Otherwise, PDR_{Coop} is the same as PDR_{dcf} in the direct

transmission scheme.

$$PDR_{i,j,m}^{Coop} = \begin{cases} PDR_{ui}PDR_{iv} & \text{if } \frac{1}{R_{ui}} + \frac{1}{R_{iv}} < \frac{1}{R_{uv}}, \\ PDR_{j,m}^{def} & \text{otherwise.} \end{cases} \quad (9)$$

For *C-ARQ*, v receives the signal from u in the direct transmission phase with data rate R_{uv} and packet delivery ratio PDR_{uv} . Meanwhile, packet delivery ratio PDR_{ui}^c is determined by R_{uv} and channel condition from the sender to the relay node. The PDR of the *C-ARQ* scheme is therefore the sum of the success probability of the direct transmission and the success probability of the cooperative retransmission, expressed as follows.

$$PDR_{i,j,m}^{Carq} = PDR_{uv} + (1 - PDR_{uv})PDR_{ui}^c PDR_{i2}. \quad (10)$$

Comparing $PDR_{i,j,m}^{Coop}$ and $PDR_{i,j,m}^{Carq}$ for all different relays $i = 1, 2, \dots, \xi_j$, the best relay and the optimal cooperative mechanism can be selected. Then, the best cooperative link metric is compared with the direct transmission link metric, $PDR_{j,m}^{def}$, to decide whether cooperation should be initiated or not. The best PDR value is chosen as the final link metric on link j , and will be used in the routing algorithm to find optimal paths.

The PDR performance for the whole path m , denoted as $PathPDR_m$, is given in the following.

$$PathPDR_m = \prod_j \max \left(PDR_{j,m}^{def}, \max_{i=1,2,\dots,\xi_j} \left(PDR_{i,j,m}^{Coop}, PDR_{i,j,m}^{Carq} \right) \right). \quad (11)$$

As shown in Eq. (11), the packet will be delivered successfully only if the packet is transmitted without errors on each link along the path, and the path with the maximal value of $PathPDR$ will be selected as the working path.

B. Effective Throughput

For traditional *direct* transmission, the throughput performance can be obtained by calculating the average number of successfully transmitted payload information bits

within average unit time consumed during the transmission:

$$\eta_{j,m}^{def} = \frac{PDR_{j,m}^{def} L}{\bar{\delta} + L/R_{uv} + L_{ACK}/R_{uv} + SIFS + DIFS}, \quad (12)$$

where L and L_{ACK} are the lengths of the DATA and ACK packets in bits respectively; and $\bar{\delta}$ is the average backoff time before each data transmission.

For *CoopMAC*, the throughput when relay i is used as a virtual hop can be expressed correspondingly in two cases:

$$\eta_{i,j,m}^{Coop} = \begin{cases} PDR_{i,j,m}^{Coop} L / D_{i,j,m}^{Coop} & \text{if } \frac{1}{R_{ui}} + \frac{1}{R_{iv}} < \frac{1}{R_{uv}}, \\ \eta_{j,m}^{def} & \text{otherwise,} \end{cases} \quad (13)$$

where $D_{i,j,m}^{Coop}$ is the time used for the transmission of the data packet through the relay in the virtual-hop relay scheme.

$$D_{i,j,m}^{Coop} = \bar{\delta} + L/R_{ui} + L/R_{iv} + L_{ACK}/R_{uv} + 2SIFS + DIFS. \quad (14)$$

Based on the same principle, the throughput of *C-ARQ* is derived as:

$$\eta_{i,j,m}^{Carq} = \frac{PDR_{i,j,m}^{Carq} L}{D_{i,j,m}^{Carq}}, \quad (15)$$

where $D_{i,j,m}^{Carq}$ is the average time used for the whole transmission procedure in the cooperative retransmission scheme, and is shown in the following.

$$D_{i,j,m}^{Carq} = \bar{\delta} + L/R_{uv} + L_{ACK}/R_{uv} + SIFS + DIFS + (L/R_{iv} + L_{ACK}/R_{iv} + L_{ACK}/R_{ui} + 2SIFS)(1 - PDR_{uv})PDR_{ui}^c. \quad (16)$$

Comparing $\eta_{i,j,m}^{Coop}$ and $\eta_{i,j,m}^{Carq}$ with all different relays $i = 1, 2, \dots, \xi_j$, we choose the highest value and then compare it with the non-cooperative link metric $\eta_{j,m}^{def}$. The higher throughput value will be used as the final link metric on link j and used for routing decision.

For the simplicity and feasibility of routing algorithms, we define the end-to-end effective throughput to be the geometric mean of the throughput on each link along the path. The effective throughput performance for the whole path m , denoted as $PathTgt_m$ is given below.

$$PathTgt_m = \frac{1}{\sum_j \left(\max \left(\eta_{j,m}^{dcf}, \max_{i=1,2,\dots,\xi_j} \left(\eta_{i,j,m}^{Coop}, \eta_{i,j,m}^{Carq} \right) \right) \right)}. \quad (17)$$

Based on the above information, the path with the maximal value of $PathTgt$ will be selected to be the working path.

C. Energy Efficiency

As mentioned earlier, the energy consumed by nodes in the idle mode is neglected in this study. Therefore, the *total* energy consumed in the network for transmitting and receiving data packets in the *direct* transmission link is calculated as follows.

$$E_{j,m}^{dcf} = (P_T + P_R)(L/R_{uv} + PDR_{uv}L_{ACK}/R_{uv}). \quad (18)$$

For *CoopMAC*, the total energy consumed during the data transmission with relay i is:

$$E_{i,j,m}^{Coop} = \begin{cases} E_{i,j,m}^{Coop} & \text{if } \frac{1}{R_{ui}} + \frac{1}{R_{iv}} < \frac{1}{R_{uv}}, \\ E_{j,m}^{dcf} & \text{otherwise,} \end{cases} \quad (19)$$

where $E_{i,j,m}^{Coop}$ is the energy consumption when the relay node is adopted to forward data, as expressed below.

$$E_{i,j,m}^{Coop} = (P_T + P_R)L/R_{ui} + (P_T + P_R)PDR_{ui}L/R_{iv} + (P_T + P_R)PDR_{ui}PDR_{iv}L_{ACK}/R_{uv}. \quad (20)$$

The first two terms in the right side of the above expression correspond to the first and the second data transmission attempts respectively, and the last term accounts for the ACK transmission when the one hop destination decodes the data packet successfully.

For *C-ARQ*, the total energy consumed during the cooperative data transmission with relay i is calculated as:

$$\begin{aligned}
E_{i,j,m}^{Carq} = & (P_T + 2P_R)L/R_{uv} + PDR_{uv}L_{ACK}/R_{uv} + \\
& (P_T + P_R)(1 - PDR_{uv})PDR_{ui}^c L/R_{iv} + (P_T + P_R) \\
& (1 - PDR_{uv})PDR_{ui}^c PDR_{iv}(L_{ACK}/R_{iv} + L_{ACK}/R_{u2}),
\end{aligned} \tag{21}$$

where the first term in the right hand side corresponds to the direct DATA packet transmission; the second term corresponds to the ACK transmission when the direct transmission succeeds; the third term accounts for the cooperative DATA packet retransmission which happens when relay i decodes the data packet from the sender correctly; and the last term accounts for the ACK transmission when the receiver decodes the data packet successfully after the cooperative retransmission.

Similar to the effective throughput metric, the energy efficiency for the whole path is shown as follows, and the path with the maximal value of *PathEfy* will be selected as the best path for cooperative communication.

$$PathEfy_m = \frac{1}{\sum_j \left(\max \left(E_{j,m}^{dcf}, \max_{i=1,2,\dots,\xi_j} \left(E_{i,j,m}^{Coop}, E_{i,j,m}^{Carq} \right) \right) \right)}. \tag{22}$$

IV. ROUTING ALGORITHM AND IMPLEMENTATION

After introducing all the different routing metrics in Sec. 3, we will explain the cooperative routing procedure, i.e., how the cooperative metrics are exploited and used for making routing decision.

In our network, the relays are selected from the neighboring nodes of a transmitter-receiver pair, and these relays generate their own traffic as well. Path establishment starts from a traditional routing procedure first, and the nodes send packets and obtain information from each other, e.g., channel information (SNR in our case) for each link. Based on the gathered information, the cooperative metrics are updated. Thereafter, new routes will be set up with the updated cooperative metrics. The routing algorithm is summarized as follows.

Algorithm: Find_Path(G, S, D)

Input: $G = (V, E)$

Edge-weighted graph (network topology)
with an SNR value on each link:

S : source node;

D : destination node.

Output: Best path array from S to D .

Step 1: For every edge (u, v) in $E(G)$,
compute cooperative metric of link (u, v) ,
(Link PDR/Throughput/Energy Efficiency)
based on the given SNR values, for each
potential relay with different MAC schemes
(e.g. *CoopMAC* and *C-ARQ*).

Step 2: Compare all cooperative metrics,
select the optimal value as
cooperative weight, $w^*(u, v)$.

Step 2: Compare $w^*(u, v)$ with non-cooperative metric $w(u, v)$,
select the better value as new weight, $w'(u, v)$.

Step 4: Generate $G' = (V, E')$ with new weight matrix, w' .

Step 5: Use the modified Dijkstra's algorithm
to find the best path from S to D .

The proposed routing algorithm follows the same principle as the original Dijkstra's shortest path algorithm, but updated with small modifications for analogous operations. The pseudocode of the implementation is given below.

In our algorithm, different metrics have different operations to calculate link cost. With regard to routing based on packet delivery ratio, the link cost is the probability of

unsuccessful transmission through the link. The data packets are delivered successfully to the destination along the path only when the transmission on each link is successful. Therefore, in the modified Dijkstra's algorithm, we use $1 - (1 - \text{cost}[u])\text{linkmetric}(u, v)$ operation instead of 'sum' operation to calculate the cost accumulated along the path. In our simplified scenario, the average end-to-end throughput is the geometric mean of the throughput on each link, and the link cost is the reciprocal value of the link throughput. As shown in the following function, the accumulated cost along the path with regard to throughput is calculated using $\text{cost}[u] + 1/\text{linkmetric}(u, v)$. The routing algorithm for energy efficiency shares the same principle with the algorithm for throughput, with the reciprocal value of the energy efficiency on each link as its link cost.

```
function modified Dijkstra(G, S, D):
  for each vertex v in Graph:
    // Initializations
    cost[v] := infinity ;
    // Unknown cost function from S to v
    previous[v] := undefined ;
    // Previous node in optimal path from S
  end for ;
  cost[S] := 0 ;
  Q := the set of all nodes in Graph;
  while Q is not empty:
    u := vertex in Q with smallest cost[];
    if cost[u] = infinity:
      break ;
    //remaining vertices inaccessible from S
  fi ;
  remove u from Q ;
  for each neighbor v of u:
    // where v has not yet been
      removed from Q.
temp := 1- (1-cost[u]) linkmetric(u,v);
```

```

    //link cost for PDR
temp := cost[u] + 1/linkmetric(u,v) ;
    //link cost for Throughput
        or Energy Efficiency
    if alt < cost[v]:
        cost[v] := temp ;
        //Update new metric
        previous[v] := u ;
        //Update new path
    fi ;
    end for ;
end while ;
return cost[] ;
path := empty sequence
//find shortest path between S and D
d := D
while previous[d] is defined:
    insert u at the beginning of path
    d := previous[d]
end while
return path;
end modified Dijkstra.

```

With respect to possible real-life implementation of our algorithm, it is highly feasible to integrate the above cooperative routing scheme with popular routing protocols such as the Optimized Link State Routing Protocol (OLSR) protocol. OLSR is a proactive link-state routing protocol designed for mobile ad hoc networks, which uses HELLO messages for neighbor discovering and then Topology Control (TC) messages for disseminating link state information throughout the whole network [20]. In order to extend OLSR to a metric-based routing protocol, link quality extensions have been introduced in [21], where HELLO messages and TC messages are augmented with the link quality

information of all neighboring nodes. To integrate cooperative communication into routing decision, the metric for each link needs to be updated according to the cooperative MAC scheme, and the routing decision is made based on the updated new link metrics, as calculated in Sec. III.

V. SIMULATIONS AND NUMERICAL RESULTS

To evaluate the performance of the proposed cooperative routing scheme, we have implemented the DCF, CoopMAC and C-ARQ mechanisms and the modified Dijkstra's routing algorithm described in the previous section in MATLAB.

A. Simulation Setup

A simple network topology with 6 nodes is configured in our simulations, as shown in Fig. ???. The path loss exponent τ is set to be 4.0 to represent indoor environments. The power consumption for transmission is set to be 1400 mW and the power consumption for reception is 900 mW [22]. The channels between each transmission pair are set as independent Rayleigh fading channels. Other simulation parameters are listed in Table F.1.

TABLE E.1: Simulation Parameters.

| | | | |
|------------------------|-----------|---------------------------|------------|
| L_{ACK} | 14 Bytes | W | 20 MHz |
| L_{DATA} | 500 bytes | CW_{min} | 15 |
| P_T | 1400 mW | DIFS | 34 μ s |
| P_R | 900 mW | SIFS | 16 μ s |
| Basic datarate | 6 Mbps | Slottime | 9 μ s |
| RF efficiency α | 0.5 | Path loss exponent τ | 4.0 |

The transmission rate of the data packet is determined according to the average SNR value of the received signal at the receiver. The required channel conditions are assumed to be obtained beforehand and the overhead for channel estimation is ignored in this study. The MCS set and their corresponding parameters are listed in Table. G.2.

E_t/N_0 is used to describe channel conditions in our study, instead of E_b/N_0 , where E_t is the transmitted energy per bit at the transmitter. The reason is that when there are multiple transmitters (sender and relay) in the network with fixed transmitting power, the received signal strength from a transmitting node that is closer to the receiver is higher,

TABLE E.2: Modulation and Coding Scheme Set.

| MCS Index n | 0 | 1 | 2 | 3 | 4 |
|-------------------|------|-------------------|-------------------|-------------------|-------------------|
| Modulation | BPSK | QPSK | 16QAM | 16QAM | 64QAM |
| Code Rate | 1/2 | 3/4 | 1/2 | 3/4 | 3/4 |
| Data Rate(Mbps) | 6 | 18 | 24 | 36 | 54 |
| SNR_n^{th} (dB) | -1.0 | 3.0 | 4.0 | 6.0 | 9.0 |
| Scope (dB) | <12 | 12 ~ 16.8 | 16.8 ~ 17.5 | 17.5 ~ 18 | >18 |
| β_n | 0.2 | 2.3×10^3 | 2.6×10^4 | 1.1×10^5 | 1.2×10^6 |
| κ_n | 2.8 | 2.5 | 2.4 | 1.9 | 1.5 |

resulting in higher received SNR and better performance. Therefore, E_t/N_0 is a more sensible metric to illustrate the performance with transmitters at different locations.

B. Simulation Results

a. Routing Path Illustration

Firstly, we set E_t/N_0 as 140 dB and observe the routing path obtained through the traditional routing protocol versus the path established through the cooperative routing protocol. In the network topology in Fig. E.3, with this E_t/N_0 value, most nodes can hear each other, except that Node D cannot hear Node S or Node R_2 due to the long distances between them.

The optimal path from source (Node S) to destination (Node D) is shown in Fig. E.4, for traditional and cooperative routing respectively using PDR as the metric. The values on the lines are the packet delivery ratio in each link. We can observe that in traditional routing, the data packet is sent to the destination using R_2 , R_4 and R_1 in succession as intermediate hops to guarantee a high packet delivery ratio. However, in cooperative routing, Node R_2 will use Node R_1 as its second hop and Node R_4 as its relay node with *C-ARQ* scheme. The reason is that under the given scenario and channel condition, the link between R_2 and R_1 , with R_4 forwarding the packet when the direct transmission fails, can provide higher packet delivery ratio than the combined link from R_2 to R_4 and from R_4 to R_1 when the packet is transmitted in a two-hop manner. The benefits of the cooperative routing will be shown in the second part of the subsection.

Fig. E.5 illustrates the optimal paths selected by the traditional routing and cooperative routing protocols respectively when throughput is used as the metric. The values

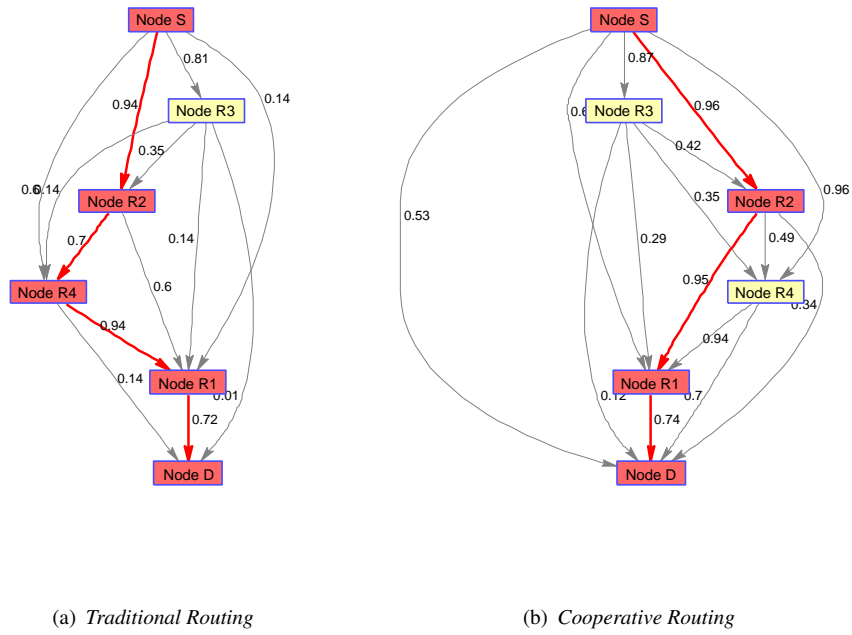

FIGURE E.4: Route for Highest Packet Delivery Ratio.

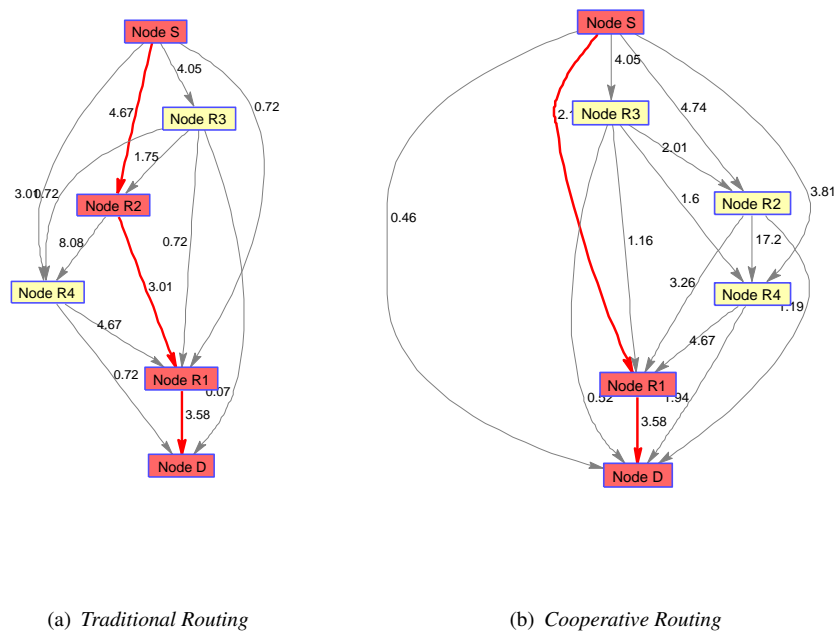

FIGURE E.5: Routing for Highest Throughput.

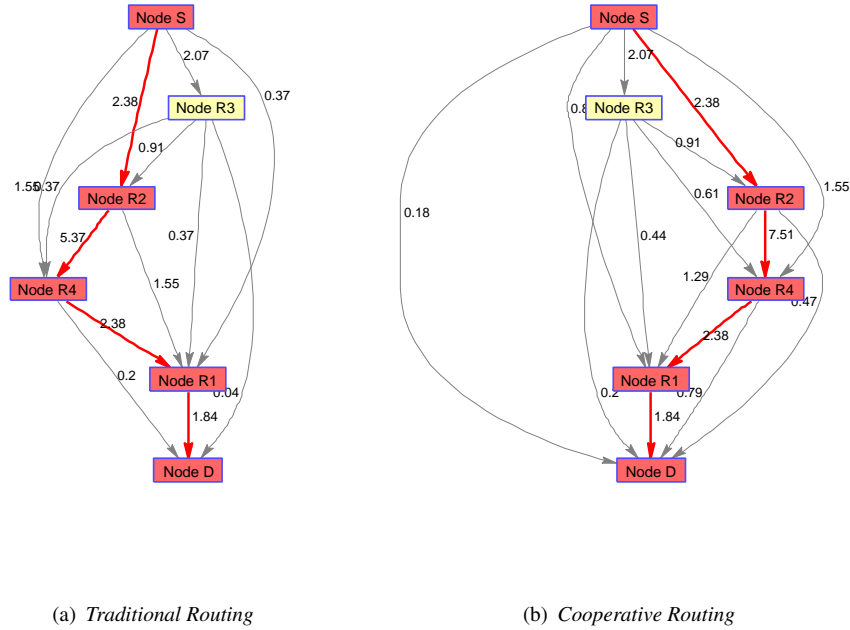

FIGURE E.6: Routing for Highest Energy Efficiency.

on the lines are the corresponding link effective throughput in $Mbps$. It is shown that the best path for the traditional routing is the path from S through R_2 and R_1 to Node D. However, in cooperative routing, Node S will send packets to R_1 , with R_4 as its relay node with $C-ARQ$. Similarly to routing for the highest PDR case, higher throughput can be achieved through the link between S and R_1 with R_4 as a relay for cooperative retransmission than the combined links from S to R_2 and from R_2 to R_1 .

The optimal paths with regard to energy efficiency are shown in Fig. E.6. The values on the lines are the corresponding link energy efficiency values in bit/J . Evident from the figure, both the traditional and cooperative routing protocols have chosen the long path through R_2 , R_4 and R_1 to Node D. It means that data transmission between the transmitter and receiver pair with the shortest distance is most energy efficient in the given scenario, no matter the traditional or cooperative routing is employed.

b. Performance Comparison

Secondly, we investigate the performance of cooperative routing in comparison with traditional routing under different channel conditions.

Fig. F.3 illustrates the PDR performance comparison between the cooperative routing and the traditional routing. From the figure, we can observe that the PDR performance can be improved significantly when cooperative routing is applied, especially when E_b/N_0 is above 135 dB. That is because a high order MCS scheme is adopted in the original scheme and the packet delivery ratio is decreased as a result. Cooperative routing protocol adopts the relay node in the network to forward the unsuccessful packet and therefore enhances the performance. However, the benefit is not significant when E_b/N_0 is around 135 dB, because when the channel quality is too poor, the probability for a relay node to decode the packet and retransmit successfully is also low. With ideal channel conditions, cooperative routing will not be beneficial anymore. This is in accordance with the intuition that the original direct transmission mechanism can provide error-free data delivery in this case and therefore no cooperations are needed.

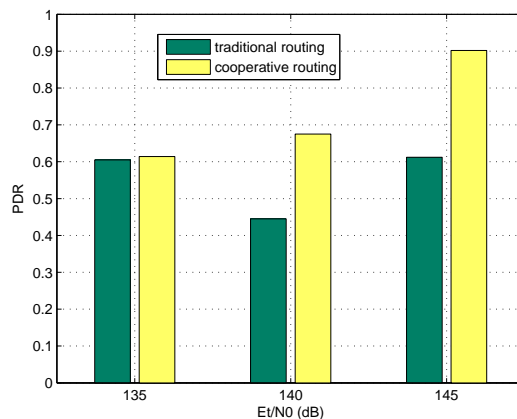

FIGURE E.7: Traditional Routing vs. Cooperative Routing: PDR.

Furthermore, the throughput performance comparison under different channel conditions is shown in Fig. E.8. We can observe that the throughput is enhanced noticeably by cooperative routing when E_b/N_0 is around 135 dB and 140 dB. The enhancement is evident in terms of both higher packet delivery ratio and less data transmission time. However, when E_b/N_0 further increases to 145 dB, cooperative routing has no performance advantage. That is again due to the fact that under excellent channel conditions, traditional routing is as efficient enough in finding the optimal path without cooperative transmissions.

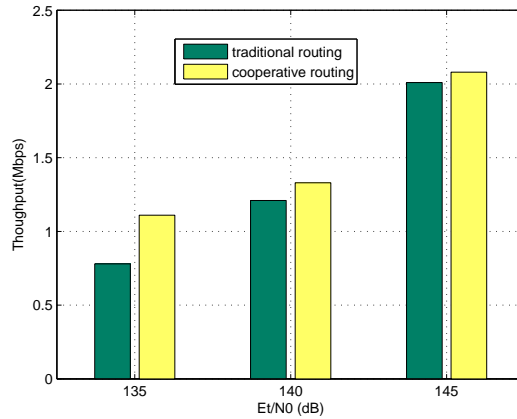

FIGURE E.8: Traditional Routing vs. Cooperative Routing: Throughput.

Finally, the numerical results based on energy efficiency for end-to-end data transmission are shown in Fig. E.9. It is obvious that there is no evident difference between cooperative routing and traditional routing. In other words, the traditional communication has equivalent performance as cooperative communications when it comes to energy efficiency. Therefore, we can conclude that in given scenarios, the network does not get benefits from cooperative communication.

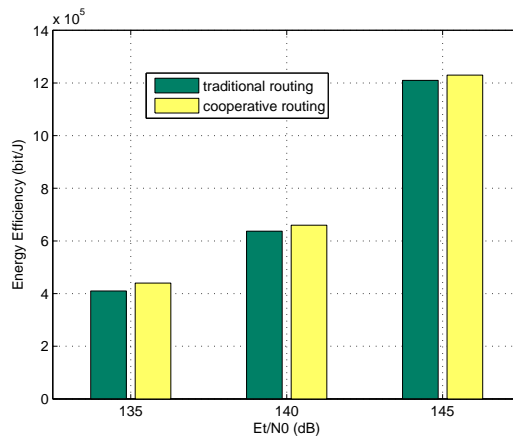

FIGURE E.9: Traditional Routing vs. Cooperative Routing: Energy Efficiency.

VI. CONCLUSIONS AND FUTURE WORK

The research effort on how to apply cooperative communication into routing decisions in multi-hop wireless networks is still in its infant stage. In this paper, we propose a metric-based routing scheme that integrates both cooperative MAC mechanism selection

and relay selection into routing decision making. Various routing metrics are proposed considering link reliability, throughput and energy consumption.

The network performance with cooperative routing is evaluated using a simple network topology. The obtained numerical results demonstrate that cooperative communication is effective for PDR performance enhancement but less effective for throughput enhancement. Furthermore, cooperative communication has basically no advantage over traditional transmission with regard to energy efficiency for the scenarios studied in this work.

The simulations in our work were done by implementing the routing algorithm and applying it to a simple network topology. Certainly, it could be more convincing with results provided from real-life network testbeds. Integrating a complete routing protocol with the proposed cooperative routing metrics is left for future work. In addition, our focus is only on static networks such as wireless mesh networks in this study therefore node mobility is not taken into consideration. Although the proposed routing algorithm may apply to mobile ad hoc networks in principle, how effective cooperative communications are as well as extra protocol overhead introduced due to mobility are left for further investigation.

APPENDIX

The PER estimation of the modulation with convolutional code schemes in 802.11g is illustrated here. The parameters of κ_n and β_n in Eq. (5) are tuned to achieve the least mean square deviation for each MCS scheme through Monte Carlo simulations. With a packet length of 500 bytes, the tuned parameters for different MCS mode are provided in Table. G.2. Evident from Fig. E.10, the resulted PER estimation approximates well to the simulated PER values for all the MCS modes. Therefore, this approximate PER expression can be used to facilitate performance analysis.

References

- [1] J. Cai, X. Shen, & J. W. Mark, Semi-distributed user relaying algorithm for amplify-and-forward wireless relay networks, *IEEE Trans. Wireless Comm.*, 7(4): 1348-1357, 2008.

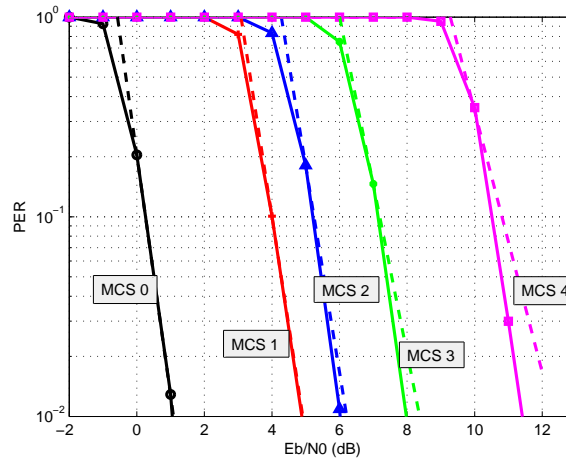

FIGURE E.10: Parameters Tuning for PER Estimation.

- [2] T. M. Cover, & A. A. E. Gamal, Capacity theorems for the relay channel. *IEEE Trans. Inform. Theory*, 25(5): 572-584., 1979.
- [3] J. N. Laneman, D. N. C. Tse, G. W. & Wornell, Cooperative diversity in wireless networks: efficient protocols and outage behavior. *IEEE Trans. Inform. Theory*, 50(12): 3062-3080, 2004.
- [4] J. N. Laneman, D. N. C. Tse, G. W. & Wornell, An efficient protocol for realizing cooperative diversity in wireless networks. *Proceedings of IEEE ISIT*, 1: 294, 2001.
- [5] T. E. Hunter, & A. Nosratinia, Cooperative diversity through coding. *Proceedings of IEEE ISIT*, 1: 220, 2002.
- [6] J. Alonso-Zarate, E. Kartsakli, C. Verikoukis, & L. Alonso, Persistent RCSMA: A MAC protocol for a distributed cooperative ARQ scheme in wireless networks. *EURASIP Journal on Advances in Signal Processing*, 2008: 13, 2008.
- [7] A. Azgin, Y. Altunbasak, & G. AlRegib, Cooperative MAC and routing protocols for wireless ad hoc networks. *Proceedings of IEEE GLOBECOM*, 5: 2854-2859, 2005.
- [8] S. Moh, C. Yu, S. Park, & H. Kim, CD-MAC: Cooperative diversity MAC for robust communication in wireless ad hoc networks. *Proceedings of IEEE ICC*, 1: 3636-3641, 2007.

- [9] X. He, F. Y. Li, Cooperative MAC design in multi-hop wireless networks: part I: when source and destination are within the transmission range of each other, *Wireless Personal Communications*, 57:339-350, 2011.
- [10] P. Liu, Z. Tao, S. Narayanan, T. Korakis, & S. Panwar, CoopMAC: A cooperative MAC for wireless LANs. *IEEE JSAC*, 25: 340-354, 2007.
- [11] B. Gui, L. Dai, & L. J. Cimini, Routing strategies in multihop cooperative networks, *IEEE Trans. Wireless Comm.*, 8(2): 843-855, 2009.
- [12] S. Chen, U. Mitra, & B. Krishnamachari, Cooperative communication and routing over fading channels in wireless sensor networks, *Proceedings of IEEE International Conference on Wireless Networks, Commun., and Mobile Comp. (WirelessCom)*, 2: 1477-1482, 2005.
- [13] R. Ramanathan, Challenges: a radically new architecture for next generation mobile ad hoc networks, *Proceedings of MobiCom* , 1: 188-197, 2005.
- [14] A. E. Khandani, J. Abounadi, E. Modiano, & L. Zheng, Cooperative routing in static wireless networks, *IEEE Trans. Communications*, 55(11): 2185-2192, 2007.
- [15] S. Moh, Two cooperation models and their optimal routing for cooperative diversity in wireless ad hoc networks, *Proceedings of IEEE International Symposium on Wireless Communication Systems (ISWCS)*, 1: 57, 2008.
- [16] K. Vijayasankar, L. N. Kannan, M. Tacca, & A. Fumagalli, CETT: A cross layer routing metric for cooperative wireless Ad hoc networks, *Proceedings of IEEE International Symposium on Modeling, Analysis & Simulation of Computer and Telecommunication Systems (MASCOTS '09)*, 1: 1, 2009.
- [17] Q. Liu, S. Zhou, & G. B. Giannakis, Cross-layer combining of adaptive modulation and coding with truncated ARQ over wireless links. *IEEE Trans. Comm.*, 3(5): 1746-1755, 2004.
- [18] X. He, F. Y. Li, & J. Lin, Link adaptation with combined optimal frame size and rate selection in error-prone 802.11n networks, *Proceedings of IEEE International Symposium on Wireless Communication Systems (ISWCS)*, 1: 733-737, 2008.

-
- [19] Wireless lan Medium Access Control (MAC) and Physical Layer (PHY) specifications.
- [20] T. Clausen, & P. Jacquet, Optimized Link State Routing Protocol (OLSR), IETF RFC 3626, 2003.
- [21] Link Quality Extensions to OLSR. [Online]. Available: <http://www.olsr.org/docs/README-Link-Quality.html>.
- [22] I. Ebert, S. Aier, G. Kofahl, A. Becker, B. Bums, & A. Wolisz, Measurement and simulation of the energy consumption of an WLAN interface. Tech. Rep. TKN-02-010, *Technical University Berlin Telecommunication Networks Group*, Germany, 2002.

COOPERATIVE COMMUNICATION DESIGN WITH DISTRIBUTED CODE ALLOCATION IN A CLUSTERED NETWORK

Title: Cooperative Communication Design with Distributed Code Allocation in a Clustered Network

Authors: **Xin He** and Frank Y. Li

Affiliation: Department of Information and Communication Technology, University of Agder, P. O. Box 509, N-4898 Grimstad, Norway

Conference: *IEEE International Symposium on Personal, Indoor and Mobile Radio Communications (PIMRC)*, Toronto, Canada, September 2011.

Copyright: ©IEEE

Cooperative Communication Design with Distributed Code Allocation in a Clustered Network

Xin He and Frank Y. Li

Dept. of Information and Communication Technology,

University of Agder (UiA)

N-4898 Grimstad, Norway

Email: {xin.he; frank.li}@uia.no

Abstract — A major challenge for cooperative communication in distributed networks is to coordinate relay transmissions without introducing too much overhead. Targeting a clustered network, we propose a novel cooperative communication scheme including channel quality based relay selection and distributed space-time code allocation in this paper. Both analysis and simulations are carried out to investigate the performance of the proposed cooperative scheme, in terms of packet delivery rate, throughput and energy efficiency, under different channel conditions and network density.

I. INTRODUCTION

Cooperative communications in wireless networks have gained a lot of attention recently in the research community. The network performance, such as reliability and throughput, can be improved by allowing several single-antenna terminals to cooperatively forward information for each other.

There exist a few publications in the literature that focus on distributed space-time coding in cooperative networks. For example, a virtual Multiple-Input-Multiple-Output (MIMO) scheme based on Space-Time Block Code (STBC) is proposed in [1], using multiple cooperative sensors to provide transmission diversity in Wireless Sensor Networks (WSNs). In [2], the authors propose a distributed beamforming scheme, in which the source and cooperative relays adjust the phase of their transmissions so that their signals can coherently be added at the destination node. Another virtual MIMO transmission scheme based on V-BLAST is proposed in [3], which is coupled with multi-hop transmissions to maximize network lifetime. [4] analyzes the performance of an energy-efficient cooperative scheme in a clustered WSN, and the overall energy consumption is

further minimized by power allocation between the intra-cluster and inter-cluster transmissions.

In the above mentioned virtual MIMO schemes, each node emulates a specific array element of a multiple-antenna system based on the assumption that the array element allocated for each relay is known beforehand. However, to apply distributed space-time codes in practice, certain code distribution algorithms are needed to assign code matrix columns to individual cooperators. In fact, code allocation is a critical and challenging task in distributed cooperative networks. So far, very few publications in cooperative communications have addressed this issue. A recent study that is closely related to code allocation is presented in [5], where the number of relaying nodes is modeled as a random variable, and each relay node randomly selects a column from an orthogonal space-time code matrix. However, this randomized code selection scheme introduces extra complexity to the physical layer system. Moreover, full diversity cannot be achieved if the total number of relaying nodes is not large enough.

In this paper, a novel cooperative communication scheme in a clustered network scenario is proposed. Cooperation issues are addressed comprehensively, including distributed code allocation and transmission coordination. To the best of our knowledge, this is the first proposal that deals with channel quality based relay selection and space-time code allocation in a coordinated manner. The performance of the proposed scheme is evaluated in terms of Packet Delivery Ratio (PDR) and throughput through both analysis and simulations. Furthermore, the proper number of cooperating relays is investigated when the energy consumption during cooperative retransmissions is taken into consideration.

The rest of the paper is organized as follows. After the system model is introduced in Sec. II, the proposed cooperative scheme is described in Sec. III. The performance analysis is given in Sec. IV, and the simulation and numerical results are presented in Sec. V. Finally, a conclusion is drawn in Sec. VI.

II. SYSTEM MODEL AND ASSUMPTIONS

In this study, we consider a clustered wireless network as shown in Fig. F.1, where several nodes are randomly distributed in a small-scale area with a remote sink. This type of clustered network architecture is typical for wireless sensor networks.

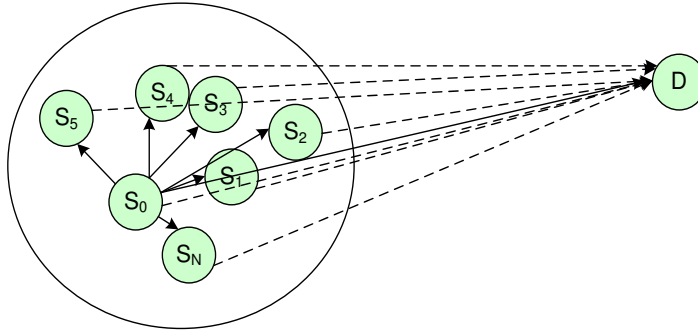

FIGURE F.1: Clustered Network Model for Cooperative Communications.

All the nodes in the network can hear each other. The source node, S_0 , sends packets directly to the destination node, D . If the direct transmission fails, other nodes in the cluster that have decoded the data packet correctly will be assigned a column from an orthogonal space-time code matrix. Thereafter, all the qualified relays and S_0 will encode the data with their assigned codes respectively, and then transmit their coded packets simultaneously towards the destination.

In the system model, we assume that the distance among any two nodes inside the cluster (intra-cluster distance) is much shorter than the distance from S_0 to D . Therefore, the synchronization of simultaneous transmissions from different relays is no longer a problem. It is also assumed that channel fading between each transmission pair, i.e., from S_0 to D , from S_0 to S_i and from S_i to D is independent of each other. Furthermore, we assume slow varying channels, i.e., identical constant channel fading during two consecutive transmissions on the same channel.

III. COOPERATIVE SCHEME DESCRIPTION

Three phases potentially exist in the proposed cooperative transmission scheme, as shown in Fig. F.2: *I) Direct Transmission*, where S_0 sends out a data packet to D following the basic Distributed Coordination Function (DCF) scheme[6]; *II) Relay Declaration*, where the qualified relay nodes declare themselves according to their instantaneous relay channel conditions; and *III) Cooperative Retransmission*, where the selected relay nodes send their coded packets together with S_0 , using the allocated space-time code elements.

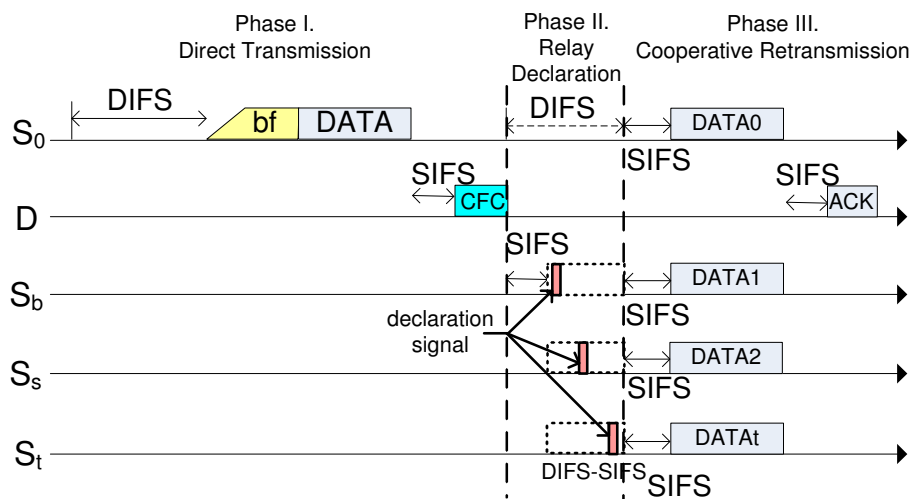

FIGURE F.2: Cooperative Scheme with Space-Time Code Allocation.

III.A Phase I. Direct Transmission

As the first step, once S_0 identifies that the channel has been idle for a DCF InterFrame Space (DIFIS) interval, it executes a backoff (bf) process and then transmits the DATA packet. If the transmission succeeds, an acknowledgment (ACK) frame will be returned to S_0 after a Short InterFrame Space (SIFS) interval. Otherwise, D will broadcast a Call For Cooperation (CFC) packet to invite other nodes in the network as relay nodes for cooperative retransmission. The CFC packet also provides relay nodes with the opportunity to measure their relay channel quality. The CFC frame format is similar to the format of a Request To Send (RTS) frame, but with a broadcast address in its address field, and the packet is transmitted at the basic data rate in order to invite as many relay nodes as possible.

III.B Phase II. Relay Declaration

In the relay declaration phase, the relay nodes with successful reception of the packet from the direct transmission will declare themselves to the whole network, using different backoff time. The declaration procedure is done by allowing a relay candidate to send a short signal over the wireless channel, which can be a tone within the allotted spectrum of the wireless network [8].

It is assumed that the CFC packet is always received by all relay candidates. After receiving the CFC packet, each relay candidate waits for a SIFS interval for hardware

to switch from receiving to transmitting, and then backoff for Δ_i before sending out its declaration signal. Δ_i is defined as:

$$\Delta_i = \frac{SNR_{low}}{SNR_i}(\text{DIFS} - \text{SIFS}), i = 1, 2, \dots, N, \quad (1)$$

where SNR_i is the Signal-to-Noise Ratio (SNR) value in dB of the CFC packet at S_i and SNR_{low} is the threshold of SNR_i for relays to participate. If SNR_i is lower than SNR_{low} , the relay channel quality is regarded to be too poor for the relay to forward the packet successfully. The value of SNR_{low} can be determined according to the specified Modulation and Coding Schemes (MCSs) at the physical layer.

According to Eq. (1), the best relay node, S_b , which has the highest received signal strength SNR_b , will have the shortest backoff time Δ_b , and then firstly send its declaration signal to the channel. All the other relay candidates in the network will declare themselves similarly. In this way, all the relay nodes are ranked in a descending order of their instantaneous relay channel quality¹.

The upper bound of Δ_i is DIFS-SIFS. This ensures that the cooperative transmission is not interrupted by other contending nodes in the network. If no relay nodes declare themselves within this duration, S_0 will contend for channel access and send the DATA packet again. On the other hand, if two or more relay nodes share the same backoff time, collision will happen to their declaration signals. In principle, with fine tuned granularity of Δ_i , collisions of different declaration signals can be avoided. However, as a consequence of finer granularity, the declaration signals will cover a shorter distance and less time is reserved for hardware preparation. For convenience, one microsecond is adopted here as the granularity and the declaration signal duration to cover 300 meters in the cluster.

The rationale of the declaration procedure is twofold. Firstly, the relay nodes with better relay channel quality can be selected for cooperation. In general, the more transmitting relay nodes, the higher success probability through cooperative retransmission. However, more energy will be consumed, and higher complexity will be introduced to the design and processing of a large space-time code matrix. Therefore, in practice, it is

¹The mapping from SNR_i to Δ_i can also be implemented through a look-up table. The boundaries involved in this table can be optimized to minimize the probability of two or more relays with the same backoff time. The optimization solution is however beyond the scope of this paper.

better to choose only a few optimal relays to transmit, instead of using all the qualified relays.

Secondly, using the above ranking sequence from the declaration signals, each relay candidate can be assigned a space-time code element for simultaneous cooperative retransmission, as explained in details in the next subsection.

III.C Phase III. Cooperative Retransmission

The protocol proceeds to the cooperative retransmission phase after the relay declaration procedure. By detecting all the declaration signals on the channel, all nodes in the cluster will be aware of the number of participating relay nodes and their corresponding ranking numbers according to the time sequence of the declaration signals. Then, from an orthogonal space-time code matrix set, which is pre-defined and known to each node in the network, a code matrix of a proper size is selected according to the number of participating relays. The influence of different numbers of selected relays will be discussed through simulations in Sec. V. Next, by using its ranking number, each relay node can find its corresponding element in the selected code matrix.

Various kinds of space-time code matrices can be adopted, such as *Spatial Spreading*, *V-BLAST*, *STBC* and *Beamforming*. In this study, we use STBC for implementation due to its relaxed restrictions on the number of antennas at the destination. An STBC matrix for three transmitters is shown in Eq. (2) as an example, where $x_i, i = 1, 2, 3$ is the i th modulated symbol in the data stream, each row represents transmission from different antennas and each column represents one antenna's transmission over time[9]¹.

$$Q^{3,3/4} = \begin{bmatrix} x_1 & x_2 & \frac{x_3}{\sqrt{2}} \\ -x_2^* & x_1^* & \frac{x_3}{\sqrt{2}} \\ \frac{x_3^*}{\sqrt{2}} & \frac{x_3^*}{\sqrt{2}} & \frac{-x_1 - x_1^* + x_2 - x_2^*}{2} \\ \frac{x_3^*}{\sqrt{2}} & -\frac{x_3^*}{\sqrt{2}} & \frac{x_2 + x_2^* + x_1 - x_1^*}{2} \end{bmatrix} \quad (2)$$

The matrix element allocation scheme can be carried out in a straightforward way. For instance, the source node can use the first column, the relay node with the first

¹ Note that for more than two antennas, orthogonal STBC suffers rate loss. In our study, the highest rate of any n_T antennas, $(n_0 + 1)/(2n_0)$, $n_T = 2n_0$ or $2n_0 - 1$, is assumed in STBC code design.

declaration signal can use the second column, and so on. Finally, all the relay nodes and the source node will transmit their coded packets together towards the destination simultaneously, with a SIFS interval after the relay declaration phase¹.

IV. PERFORMANCE ANALYSIS

In this section, we start by analyzing the Packet Error Rate (PER) of the direct transmission phase, proceed to analysis in the cooperative transmission phase in the second subsection, then conclude with the overall system performance.

IV.A Direct Transmission Phase

Let ℓ denote the distance between S_0 and D. Then, the average received SNR at D can be written as:

$$\bar{\gamma} = \frac{GP_T(1 - \alpha)}{\ell^\lambda N_0 W}, \quad (3)$$

where P_T is the power consumption during Radio-Frequency (RF) transmission; $(1 - \alpha)$ accounts for the efficiency of the RF power amplifier; λ is the path loss exponent; W is the bandwidth in Hertz available for transmission; N_0 is the spectral power density of the Gaussian white noise at the receiver; and G is a constant that is decided by the signal frequency, antenna gains, and other parameters.

We assume Rayleigh fading channels in this study, but our analysis can be extended to other fading channels as well such as Rician or Nakagami. The instantaneous received SNR under Rayleigh fading has an exponential distribution as:

$$f(\gamma) = 1/\bar{\gamma} e^{-\gamma/\bar{\gamma}}. \quad (4)$$

¹Though the probability is small, still it may happen that two or more relay candidates have the same backoff time, and hence use the same code for transmission. In this case, the protocol still performs as usual, but no spatial diversity will be achieved among these two or more relay nodes with identical space-time code elements.

We rely on the following approximate PER expression[7] to facilitate the PER performance analysis:

$$PER_d(\gamma) \approx \begin{cases} 1 & \text{if } \gamma \leq \gamma^{th} \\ \beta e^{-\kappa\gamma}, & \text{if } \gamma > \gamma^{th} \end{cases} \quad (5)$$

where β , κ and γ^{th} are parameters dependent on the specific MCS scheme and data packet length. The appropriate values of these parameters are obtained by fitting Eq. (5) into the exact PER from simulations.

Based on the above information, the average PER from the direct transmission can be obtained as:

$$\begin{aligned} \overline{PER}_d(\bar{\gamma}) &= \int_0^\infty PER_d(\gamma) f(\gamma) d\gamma \\ &= \frac{\beta}{1 + \kappa\bar{\gamma}} e^{-\gamma^{th}(\kappa+1/\bar{\gamma})} + \left(1 - e^{-\gamma^{th}/\bar{\gamma}}\right). \end{aligned} \quad (6)$$

In our analysis, we assume there are N nodes uniformly distributed with radius R around the source node in the cluster. Using the same method, we can obtain the average PER of the transmissions between the source and the relay nodes, $\overline{PER}_r(\ell_i)$, where ℓ_i is the distance between the source and the relay node S_i . Averaging $\overline{PER}_r(\ell_i)$ over the distance leads to:

$$\overline{PER}_r = \int_0^R \overline{PER}_r(\ell_i) \frac{2\ell_i}{R^2} d\ell_i, \quad (7)$$

where,

$$\begin{aligned} \overline{PER}_r(\ell_i) &= \left(1 - e^{-\frac{\gamma^{th} \ell_i^\lambda N_0 W}{P_t G(1-\alpha)}}\right) \\ &+ \frac{\beta \ell_i^\lambda N_0 W}{\ell_i^\lambda N_0 W + \kappa P_t G(1-\alpha)} e^{-\gamma^{th} \left(\kappa + \frac{\ell_i^\lambda N_0 W}{P_t G(1-\alpha)}\right)}. \end{aligned} \quad (8)$$

Let us denote the number of nodes with successful reception of the data packet from the direct transmission as M . Since the channels from the source to different relays are

assumed to be independent, the event that one node successfully receives a packet is independent of other nodes' reception status. Thus, the number of successful nodes, M , is subject to a binomial distribution, shown as:

$$P(N, M) = \binom{N}{M} [1 - \overline{PER}_r]^M [\overline{PER}_r]^{N-M}. \quad (9)$$

IV.B Cooperative Retransmission Phase

Before we draw a conclusion on the proper number of selected relays, the influence of different numbers of cooperating relays needs to be investigated. In order to do that, we perform our analysis by distributing varying numbers of relays in the network and allowing all qualified relays to transmit. Thus, including S_0 , the total number of nodes that will jointly transmit data is $M_0 = M + 1$. We next derive the average PER for the cooperative retransmission phase.

We approximate the transmission distances between all the transmitting nodes and D as ℓ , since ℓ is assumed much larger than the intra-cluster distance. Thus, the average received SNR at D from each relay node, $\bar{\gamma}_c$, can be approximated to be the same as $\bar{\gamma}$. In addition, we assume no collisions during the relay declaration procedure and perfect channel knowledge and symbol-level synchronization at D. Due to the orthogonal property, the effective received SNR is:

$$\gamma_c = \left(\sum_{i=1}^{M_0} |h_i|^2 \right) \bar{\gamma}_c, \quad (10)$$

where h_i denotes the channel fading factor between the i th transmitting node and the destination, with independent and identical distribution. Considering a Rayleigh fading distribution of h_i , γ_c is subject to a central chi-square distribution with $2M_0$ degrees of freedom as:

$$f(\gamma_c) = \frac{1}{\Gamma(M_0)\bar{\gamma}_c^{M_0}} \gamma_c^{M_0-1} e^{-\gamma_c/\bar{\gamma}_c}. \quad (11)$$

The average PER with M_0 transmitting nodes is then:

$$\begin{aligned}
\overline{PER}_c(\bar{\gamma}_c, M_0) &= \int_0^\infty PER_c(\gamma_c) f(\gamma_c) d\gamma_c \\
&= \frac{1}{\Gamma(M_0)\bar{\gamma}_c^{M_0}} \left[\int_0^{\gamma^{th}} \gamma_c^{M_0-1} e^{-\gamma_c/\bar{\gamma}_c} d\gamma_c + \beta \int_{\gamma^{th}}^\infty \gamma_c^{M_0-1} e^{-(\kappa+1/\bar{\gamma}_c)\gamma_c} d\gamma_c \right] \quad (12) \\
&= \frac{\Gamma(M_0) - \Gamma(M_0, \gamma^{th}/\bar{\gamma}_c)}{\Gamma(M_0)} + \frac{\beta \Gamma(M_0, (\kappa + 1/\bar{\gamma}_c) \gamma^{th})}{\Gamma(M_0)(1 + \kappa\bar{\gamma}_c)^{M_0}},
\end{aligned}$$

where $\Gamma(x, y)$ is the upper incomplete Gamma function.

Averaging over M_0 , we have:

$$\overline{PER}_s = \sum_{M=0}^N P(N, M) \overline{PER}_c(P_t, M + 1) \quad (13)$$

IV.C System Performance

The packet delivery ratio of the cooperative scheme is the sum of the packet successful rate in the direct phase and the additional successful rate in the cooperative retransmission phase, as:

$$PDR_c = 1 - \overline{PER}_d + \overline{PER}_d(1 - \overline{PER}_s). \quad (14)$$

The normalized system saturation throughput, denoted by η , is defined as the successfully transmitted payload bits per time unit, and can be written as:

$$\eta = \frac{E[\psi]}{E[T]}, \quad (15)$$

where $E[\psi]$ is the number of payload information bits successfully transmitted in a virtual time slot, i.e., the time interval between two consecutive packet transmissions initiated by S_0 in this study, and $E[T]$ is the expected length of the virtual time slot. For the proposed scheme, $E[\psi]$ and $E[T]$ are expressed as follows.

$$E[\psi] = PDR_c L; \quad (16)$$

$$E[T] = (1 - \overline{PER}_d)E[T_1] + \overline{PER}_dE[T_2]; \quad (17)$$

where L is the payload length in bits; $E[T_1]$ and $E[T_2]$ are the expected lengths of the virtual time slot when the direct transmission succeeds or fails respectively, as:

$$E[T_1] = E[\delta] + T_{DATA} + T_{ACK} + \text{SIFS} + \text{DIFS}; \quad (18)$$

$$E[T_2] = E[T_1] + T'_{DATA} + T_{ACK} + \text{DIFS} + 2\text{SIFS}. \quad (19)$$

In the above expressions, T_{ACK} , T_{DATA} and T'_{DATA} are the transmission time for the ACK packet, and for DATA packet during the direct transmission and the cooperative retransmission, respectively; δ is the backoff time before each packet transmission.

In order to investigate the tradeoff between performance enhancement and energy consumption during the cooperative retransmission phase, cooperative retransmission energy efficiency, Ef_c , is introduced here. Ef_c is defined as the additional successfully delivered information bits by each consumed joule of energy among all the cooperating relays, as:

$$Ef_c = \frac{PER_d(1 - PER_s)L}{\sum_{M=0}^N P(N, M)(M + 1)P_T T_T}. \quad (20)$$

V. PERFORMANCE EVALUATION

The simulation parameters are set up according to the 802.11g standard, as listed in Table F.1. S_0 and D are placed 300 meters apart from each other. Different numbers of relay nodes are placed randomly within a radius of 30 meters around the source node. QPSK with Convolutional Code (CC) rate 1/2 is adopted, with the corresponding β , κ and γ^{th} from Eq. (5) as 7.2×10^3 , 5.3, and 2.0 dB, respectively.

Fig. F.3 illustrates the PDR performance of the proposed cooperative scheme in comparison with the original DCF non-cooperative scheme under different channel conditions. The retry limit in the DCF scheme is set to 1. The simulation results generally coincide with the theoretical analysis in Sec. IV. The gap between them is caused by the inaccurate closed-form PER estimation in Eq. (5). The cooperative scheme clearly

TABLE F.1: Simulation Parameters.

| | | | |
|-------------|------------|------------------------|------------|
| DATA length | 500 bytes | ACK length | 14 Bytes |
| CFC length | 24 Bytes | MPDU header | 24 bytes |
| PHY header | 20 μ s | DIFS | 34 μ s |
| SIFS | 16 μ s | Slottime | 9 μ s |
| P_T | 1400 mW | Datarate | 12 Mbps |
| CW_{min} | 15 | RF efficiency α | 0.5 |

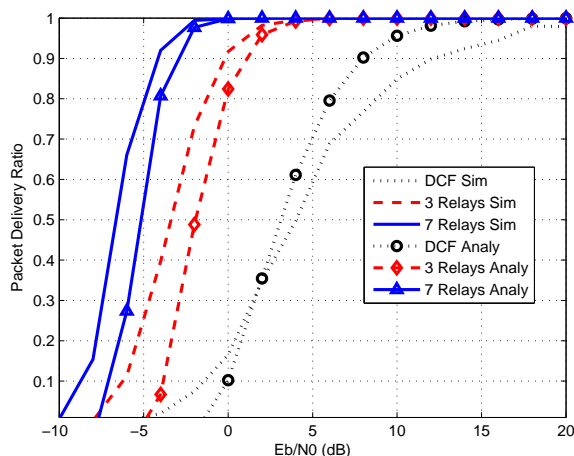

FIGURE F.3: Packet Delivery Ratio Performance Comparison.

demonstrates its advantage over the original DCF scheme. More significant improvement is observed with seven relay nodes in the cluster than with only three, especially under poor channel conditions (E_b/N_0 is below 5 dB). The reason is that with more simultaneous transmitting nodes, higher spatial diversity can be exploited, and hence the probability of a successful cooperative retransmission is increased.

The throughput performance comparison under different network scenarios is shown in Fig. F.4. Both the analytical and simulation results show that network throughput is enhanced significantly by the cooperative scheme when the channel condition is poor (E_b/N_0 is below 10 dB). We can also observe that throughput enhancement becomes more evident with more relays in the cluster, especially when E_b/N_0 is between -10 dB and 10 dB, due to higher packet delivery ratio provided by more participating relay nodes.

We further investigate the influence of the number of cooperating relay nodes on the

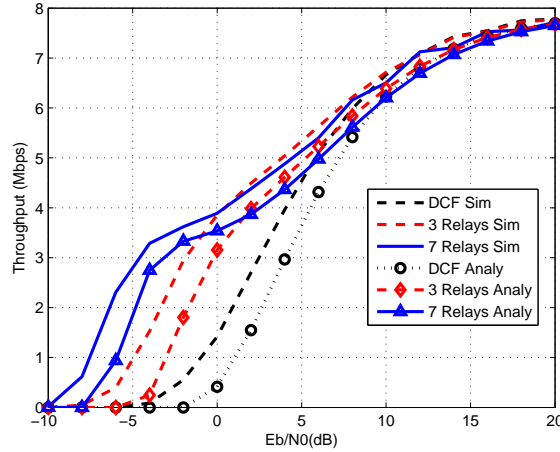

FIGURE F.4: Throughput Performance Comparison.

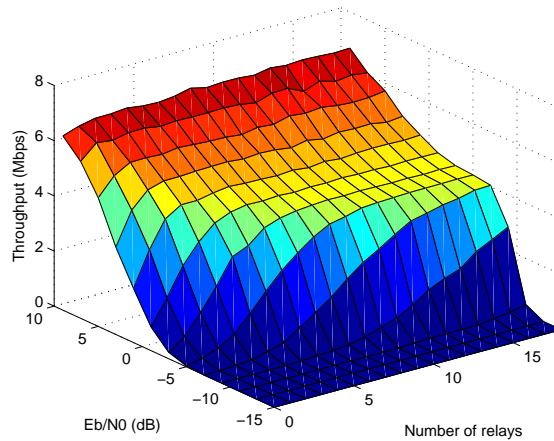

FIGURE F.5: Throughput with Different Relay Density.

performance of the proposed cooperative protocol¹. Fig. F.5 illustrates throughput performance with different numbers of the relay nodes. It is shown that the cooperative scheme with high density of relay nodes only gains benefit when the channel is in extremely poor conditions, and the throughput enhancement becomes less evident as the number of relay nodes increases.

Moreover, the energy efficiency of the cooperative scheme is investigated and the numerical results are shown in Fig. F.6. It is obvious that a small number of relays can

¹ Note that with our network configuration, almost all the relay nodes in the cluster are able to decode the data packet successfully from the direct transmission. Therefore, the number of the relays is actually the same as the number of cooperating nodes since we allow all the qualified relay nodes in cooperation. However, fewer optimal relays are recommended in practice, as discussed in Subsec. III. B and later in this subsection.

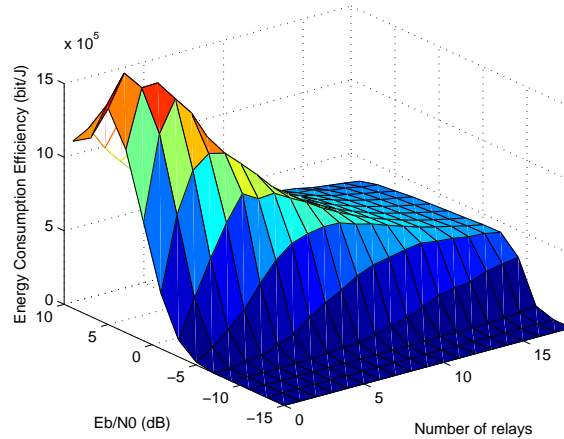

FIGURE F.6: Energy Consumption Efficiency.

provide much higher energy efficiency compared with a large number of relays when E_b/N_0 is between -5 dB and 10 dB. However, when the channel condition continues to deteriorate, a large number of cooperating relay nodes cannot provide considerable throughput enhancement either. Therefore, we can draw the conclusion that only a few relay nodes should be selected for cooperation when energy consumption is taken into consideration. Another advantage with a smaller number of relay nodes is that the design and processing of space-time coding can be simplified significantly by using only small matrices.

VI. CONCLUSIONS AND FUTURE WORK

In this paper, we have proposed a cooperative communication scheme for a clustered network, with focus on a distributed solution for code allocation and transmission coordination among different relay nodes. Significant performance enhancement is demonstrated through both analysis and simulations. Furthermore, the tradeoff between system throughput and energy consumption is investigated as the number of cooperating relays varies. The numerical results show that a small number of relays leads to higher energy efficiency, in addition to simpler space-time coding implementation. Our future work will involve a comparison between the performance of our scheme and the random code selection scheme.

References

- [1] X. Li, M. Chen, and W. Liu, "Application of STBC-encoded Cooperative Transmissions in Wireless Sensor Networks", *IEEE Signal Process. Lett.*, vol. 12, no. 2, pp. 134-137, Feb. 2005.
- [2] H. Ochiai, P. Mitran, H. V. Poor, and V. Tarokh, "Collaborative Beamforming for Distributed Wireless Ad Hoc Sensor Networks", *IEEE Trans. Signal Process.*, vol. 53, no. 5, pp. 1456-1467, Nov. 2005.
- [3] K. Xu, W. Yuan and W. Cheng, "An Energy-Efficient V-BLAST Based Cooperative MIMO Transmission Scheme for Wireless Sensor Networks", in *Proc. IEEE WCNC*, pp. 688-693, Mar. 2008.
- [4] Z. Zhou, S. Zhou, S. Cui, and J. H. Cui, "Energy-efficient Cooperative Communication in Clustered Wireless Sensor Networks", *IEEE Trans. Veh. Techno.*, vol. 57, no. 6, pp. 3618-3628, Nov. 2008.
- [5] B. Sirkeci-Mergen and A. Scaglione, "Randomized Space-Time Coding for Distributed Cooperative Communication", *IEEE Trans. Signal Process.*, vol. 55, no. 10, pp. 5003-5017, Oct. 2007.
- [6] IEEE 802 WG, "Wireless LAN Medium Access Control (MAC) and Physical Layer (PHY) Specifications" *IEEE 802.11*, 1999.
- [7] Q. Liu, S. Zhou, and G. B. Giannakis, "Cross-Layer Combining of Adaptive Modulation and Coding with Truncated ARQ over Wireless Links", *IEEE Trans. Comm.*, Vol. 3, No. 5, pp. 1746-1755, Sept. 2004.
- [8] M. G. Jibukumar, R. Datta and P. K. Biswas, "CoopMACA: a Cooperative MAC Protocol using Packet Aggregation", *Wireless Networks*, Springer, DOI: 10.1007/s11276-009-0232-8, Dec. 2009.
- [9] V. Tarokh, H. Jafarkhani, and A. R. Calderbank, "Space-Time Block Codes from Orthogonal Design", *IEEE Trans. Comm.*, vol. 45, No. 11, pp. 1927-1938, July 1999.

ENABLING CO-CHANNEL CONCURRENCY IN WLANS USING POSITIONAL CARRIER SENSE

Title: Enabling Co-Channel Concurrency in WLANs using Positional Carrier Sense

Authors: **Xin He**[†], Sriram Lakshmanan[‡], Raghupathy Sivakumar[‡] and Frank Y. Li[†]

Affiliation: [†]Dept. of Information and Communication Technology, University of Agder (UiA), N-4898 Grimstad, Norway; [‡]School of Electrical and Computer Engineering, Georgia Institute of Technology, Atlanta, GA, 30332-0205, USA

Conference: IEEE Global Telecommunications Conference (GLOBECOM), submitted in March 2012.

Enabling Co-Channel Concurrency in WLANs using Positional Carrier Sense

Xin He[†], Sriram Lakshmanan[‡], Raghupathy Sivakumar[‡] and Frank Y. Li[†]

[†]Dept. of Information and Communication Technology, University of Agder (UiA),
N-4898 Grimstad, Norway

[‡]School of Electrical and Computer Engineering, Georgia Institute of Technology,
Atlanta, GA, 30332-0205, USA

Email: [†]{xin.he; frank.li}@uia.no, [‡]{sriram; siva}@ece.gatech.edu

Abstract — An attractive approach to overcome capacity limitations in a densely deployed WLAN environment is to enable transmission concurrency. In this paper, we propose a co-channel concurrent transmission scheme called C^2SMA/CA , which allows multiple concurrent transmissions when the interference among these transmission determined using positional carrier sensing is tolerable. We present a distributed implementation of the multi-link concurrency scheduling algorithm that is backwards compatible with conventional CSMA/CA. We use simulations to evaluate the throughput improvement of C^2SMA/CA .

I. INTRODUCTION

Wireless Local Area Networks (WLANs) today are characterized by their high device density. At the same time applications that use such networks have increasingly higher bandwidth requirements. Consequently, limited spectrum availability is one of the biggest challenges in such networks.

The Distributed Coordination Function (DCF) scheme defined in the IEEE 802.11 standard is the dominant Medium Access Control (MAC) approach in WLANs due to its simple implementation and distributed nature[1]. However, the inherent Carrier Sensing Multiple Access with Collision Avoidance (CSMA/CA) mechanism does not always make correct decisions because it does not consider channel conditions at the receiver, resulting in problems like exposed and hidden terminals[2]. The Request-to-Send / Clear-to-Send (RTS/CTS) virtual carrier sensing protocol has been standardized as a

solution to tackle the hidden terminal problem at a cost of low throughput. On the other hand, no recognized solution exists for the exposed terminal problem which is caused by the overcautious channel assessment for interference estimation at receivers. More specifically, according to the DCF scheme, a transmission is deferred if the node senses the channel as busy. However, in certain cases this new transmission and the ongoing transmission may not generate interference that is severe enough to disrupt the packets at their respective receivers. Thus, many transmission attempts are blocked unnecessarily due to the overcautious protection of ongoing transmissions, leading to underutilization of network capacity.

Several approaches exist in the literature to enhance spatial reuse to mitigate the inefficient channel utilization, such as smart antennas[3], transmission power control, and carrier sense adaptation[4]. Another natural solution is to enable concurrency of co-channel transmissions when the receptions at their corresponding receivers are not affected by each other. In fact, it is observed that in a dense Wi-Fi network with multiple Access Points (APs), many clients that are associated with different APs are exposed terminals to each other [5]. This observation indicates that the network performance in infrastructure WLANs could be significantly improved by allowing interference-tolerant concurrent transmissions with accurate concurrency-decision-making and smart traffic scheduling.

There have been a few proposals to increase concurrency in wireless networks [6]~[10]. A new CS mechanism, Directional Virtual Carrier Sensing (DVCS), is proposed in [6] to enhance the original access control scheme with directional antennas. A Conflict Map (CMAP) system is proposed in [8], where a reactive channel access scheme first allows nodes to transmit concurrently even if there is a possibility of collisions, then determines whether to prohibit concurrent transmissions based on the observed loss ratios. [10] introduces symbiotic coding at the transmitters to encourage transmission concurrency, targeting a specific class of collision scenario named asymmetric collisions. Another solution is proposed in [7] to mitigate the exposed terminal problem by identifying exposed links through an offline training process. RTS-Simultaneously (RTSS) and CTS-Simultaneously (CTSS) messages are introduced to provide the coordination of simultaneous transmissions over the exposed links. In [9], the authors propose a Spatial Reuse DCF (SRDCF) scheme based upon the RTS/CTS scheme, which utilizes location

information and transmission parameters to make accurate channel assessments and to permit concurrent transmissions by adjusting transmission power.

In contrast to the aforementioned approaches, the scheme proposed in this paper is based on the basic transmission scheme, which is widely used in reality to avoid the large overhead of control packets in the RTS/CTS scheme. The proposed scheme does not require additional control packets, new coding strategies or directional transmissions. The proposed scheme targets a dense Wi-Fi network scenario with multiple APs sharing the same channel. The concurrency decision is made using position information provided by the cooperative carrier sensing of multiple antenna elements at APs, referred to as Positional Carrier Sense (PCS) in this paper. We refer to the scheme as Concurrent CSMA/CA (C^2SMA/CA) since it is based on the original CSMA/CA and uses PCS to enable co-channel concurrency. The C^2SMA/CA scheme keeps the legacy of CSMA/CA and is compatible with traditional transmissions.

The rest of the paper is organized as follows. After the network scenario and assumptions are introduced in Sec. II, the principle of the proposed concurrency scheme is described in Sec. III. The multi-link concurrency scheduling solution is introduced in Sec. IV., and then the simulation results are presented in Sec. V. Finally, a conclusion is drawn in Sec. VI.

II. NETWORK SCENARIO AND ASSUMPTIONS

We are interested in a dense wireless local network with multiple APs sharing the same channel,¹ as shown in Fig. G.1. In this network, all APs and clients are in the transmission range of each other. We assume multiple antennas at APs and a single antenna at clients, which is the typical setup in current Wi-Fi networks.

We assume that APs can get the position information of clients associated with them using cooperative positional carrier sensing through multiple antenna elements. The position information of each client (i.e., direction and distance) is shared among APs through wired transmission. Omni-transmission is assumed at both APs and clients.²

¹Even in a network where different channels can be assigned to different APs, it is still unavoidable in many cases to have multiple APs sharing the same channel due to the high density of APs and limited number of available channels (e. g., three non-overlapping channels in 802.11b/g).

²As an alternative way to use multiple antennas other than beamforming, multiple elements are used for cooperative positional carrier sense to support concurrency transmission in this study. In some scenarios where beamforming is applied, the benefits from directional transmissions will enhance the probability of concurrent transmissions in our work. The implementation and performance evaluation of concurrency schemes using beamforming is beyond the scope of this paper.

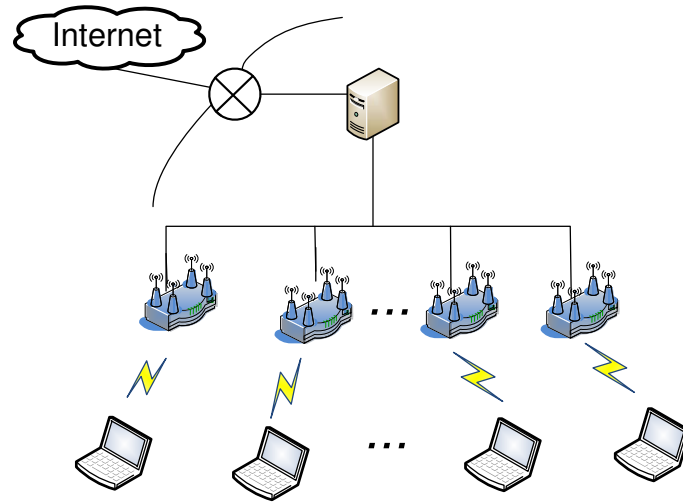

FIGURE G.1: System Model for Concurrent Transmissions.

In this network, APs listen to the channel and keep track of ongoing transmissions. They are capable of processing multiple-packet reception with successful interference cancelation to obtain traffic information [9], such as MAC address, packet length as well as Modulation and Coding Scheme (MCS).

III. CONCURRENT TRANSMISSION PRINCIPLE

Based on the observation that concurrent transmissions do not necessarily result in the loss of either colliding packet, we need to identify the opportunities of successful concurrent transmissions and enable them. In what follows, the overview of the proposed C^2SMA/CA scheme is presented first. After that, a double-link concurrency case is taken as an example to explain the concurrency principle. The link scheduling procedure is introduced in the end.

A. Concurrency Scheme Overview Two key problems for transmission concurrency are addressed in the proposed C^2SMA/CA scheme: identification of a concurrent transmission opportunity and scheduling of multiple concurrent transmissions.

To allow a new transmission link despite ongoing traffic on the channel, the following two criteria must be satisfied:

- The ongoing transmissions should not be disrupted by the new one.
- The new transmission should succeed as well.

With C^2SMA/CA , the above conditions are calculated at the new transmitting AP, using the corresponding position information and traffic information, which is obtained either from positional carrier sensing or from multiple-packet reception from the channel. If concurrency is allowed even though the channel is busy, C^2SMA/CA will arrange new transmissions according to the proposed concurrency scheduling algorithm. If the concurrent transmission is not allowed, C^2SMA/CA follows the same contention procedure as specified in the legacy CSMA/CA.

In the following, we explain the concurrency decision-making and scheduling procedure in C^2SMA/CA using a simple double-link concurrency scenario.

B. Concurrency Conditions for the Double-Link Scenario

Two APs (A1 and A2) and two clients (B1 and B2) are set up in the network. Without losing generality, we assume there is an ongoing traffic (DATA1) from A1 to B1. A2 has a packet (DATA2) for B2. Before A2 sends DATA2, A2 needs to calculate the potential results of the concurrent transmission based on the provided position information and channel conditions.

In the DCF basic scheme, if a receiver decodes the data packet successfully, an ACK packet is sent back to the source after a Short InterFrame Space (SIFS). Therefore, four possible concurrency cases might happen if the traffic between A2 and B2 takes place concurrently with the traffic between A1 and B1, namely, DATA1 with DATA2, DATA2 with ACK1, DATA1 with ACK2, or ACK2 with ACK1, as shown in Fig. G.2.

In a given scenario, not all the concurrent transmissions in Fig. G.2 are detrimental to the data receptions at receivers. If the data reception at each receiver survives the interference from another transmission, concurrency should be allowed. Assume that the Signal-to-Noise-Ratio (SNR) threshold for each transmission is known at each AP. By calculating the resulted Signal-to-Interference-Noise-Ratio (SINR) values of the packets in each possible concurrency case and comparing them with the corresponding SNR thresholds, we can determine if the concurrent transmission is possible.

For example, to allow the concurrency of DATA1 and DATA2 in Fig. G.2(a), the following two conditions need to be satisfied in order to have both packets successfully

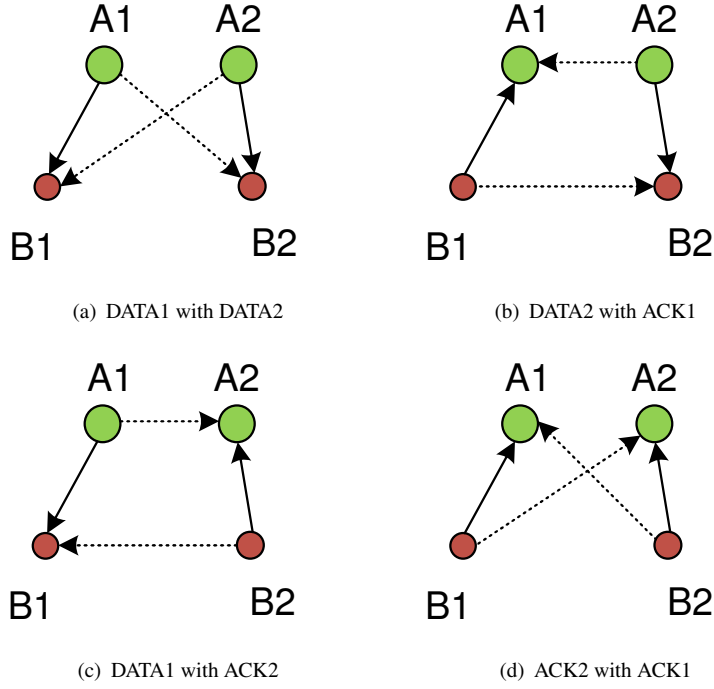

FIGURE G.2: Possible Concurrency in the Double-Link Scenario.

decoded at the receivers:

$$\frac{\frac{P_{A1}G_{A1}G_{B1}\lambda^2}{D_{A1B1}^\gamma(4\pi)^2}}{\frac{P_{A2}G_{A2}G_{B1}\lambda^2}{D_{A2B1}^\gamma(4\pi)^2} + N_0W} > SNR_{th}(DATA1), \quad (1)$$

$$\frac{\frac{P_{A2}G_{A2}G_{B2}\lambda^2}{D_{A2B2}^\gamma(4\pi)^2}}{\frac{P_{A1}G_{A1}G_{B2}\lambda^2}{D_{A1B2}^\gamma(4\pi)^2} + N_0W} > SNR_{th}(DATA2), \quad (2)$$

where P_{A1} and P_{A2} are the transmission power at A1 and A2; G_{A1} , G_{A2} , G_{B1} and G_{B2} are the transmit antenna gains at A1 and A2 and receive antenna gains at B1 and B2, respectively; λ is the wavelength; D_{A1B1} , D_{A2B1} , D_{A2B2} and D_{A1B2} are the distances from A1 to B1, A2 to B1, A2 to B2, and A1 to B2; γ is the path loss parameter; N_0W is the noise power at the receiver which is assumed to be identical for the whole system; $SNR_{th}(DATA1)$ and $SNR_{th}(DATA2)$ are SNR threshold values for the successful decoding of DATA1 and DATA2.

Following the same principle, the concurrency conditions for scenarios in the other three cases in Fig. G.2 can be obtained.

C. Scheduling the Second Link

Using the results from the previous subsection, we can schedule the secondary transmission according to which concurrent transmissions are tolerable and which are not.

TABLE G.1: Concurrency Decision with PCS.

| Case | Description | CT |
|------|---|----|
| 1111 | Free transmission | 1 |
| 1000 | Only DATA concurrency | 0 |
| 1110 | No concurrency of ACK1 and ACK2 | 1 |
| 1011 | No concurrency of DATA2 and ACK1 | 1 |
| 1101 | No concurrency of DATA1 and ACK2 | 1 |
| 1001 | Exposed terminals | 1 |
| 1100 | No concurrency of DATA1 and ACK2, ACK1 and ACK2 | 1 |
| 1010 | No concurrency of DATA2 and ACK1, ACK1 and ACK2 | 1 |
| 0100 | Symbiotic coding[10] | 0 |
| 0110 | Symbiotic coding | 0 |
| 0010 | Symbiotic coding | 0 |
| else | No concurrent transmissions | 0 |

First, we mark each of the scenarios in Fig. G.2 as 1 if the corresponding concurrency criteria are satisfied, otherwise mark it as 0. Consequently, there are 16 possible combinations from different results in each scenario. The description of all the cases is shown in Table G.1, where Case $X_a X_b X_c X_d$ ($X_i \in 0, 1; i \in a, b, c, d$) corresponds to the case that the condition for the concurrency pattern a, b, c, d in Fig. G.2 is X_a , X_b , X_c and X_d respectively. With traditional carrier sensing, the second transmission will never be allowed because the nodes are in each other's transmission range. However, with PCS, concurrent transmissions can be enabled in seven out of sixteen cases. As shown in Table G.1, for a secondary transmission to take place ('1' in the CT field), data concurrency has to be supported and ACK transmissions should be allowed after the data transmission.

After identifying potential opportunities of concurrent transmissions, we need to schedule the second transmission to avoid detrimental collisions (indicated as '0's). Taking Case 1110 as an example, all concurrent transmissions in Fig. G.2 are allowed except concurrent ACK transmissions. Therefore, we need to schedule the second transmission to avoid ACK concurrency, which means that ACK2 has to finish before ACK1 or start

after ACK1, as shown in Fig. G.3(a). In the second case (Case 1011) shown in Fig. G.3(b), the concurrency of DATA1 and ACK2 is detrimental and hence should be prohibited. Therefore, ACK2 needs to be scheduled to start after DATA1. Similarly, the

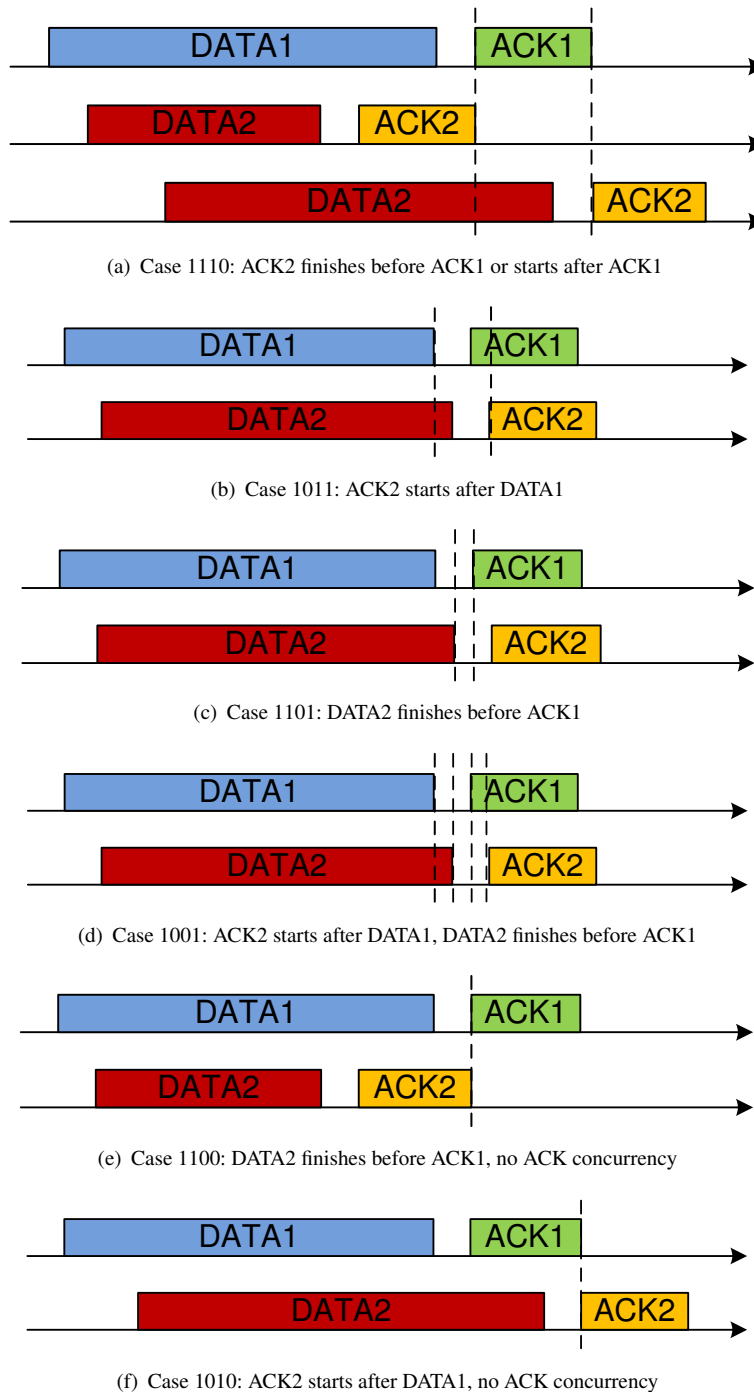

FIGURE G.3: Concurrency Scheduling of the Secondary Transmission.

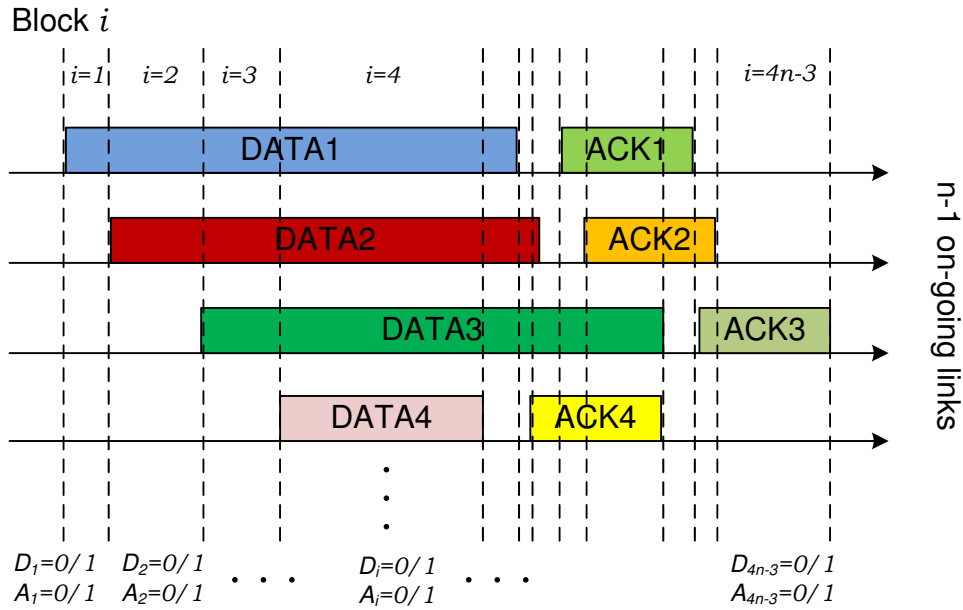

FIGURE G.4: Multi-link Concurrency Scheduling.

traffic scheduling patterns corresponding to all the other cases with the secondary transmission allowed, are also depicted in the rest of Fig. G.3.

The traffic scheduling method is straightforward by using deferring, packet fragmentation or aggregation to follow the concurrency pattern. Packet deferring and fragmentation are included in the IEEE 802.11 standard [1], while aggregation is included in the 802.11n standard[11].

IV. MULTI-LINK CONCURRENCY SCHEDULING

In a dense WLAN network with multiple APs sharing the same channel, the double-link concurrency solution illustrated in the previous section is not sufficient. C^2SMA/CA should be extended to support multiple link concurrent transmissions. In this section, the implementation algorithm of the multi-link concurrency scheme is presented.

We assume that no new traffic flows arrive at two APs at the same time. The problem can be generalized as follows. Given n ongoing transmissions, how can an AP with new traffic decide if an additional transmission is allowed, and if so, how to schedule it?

Firstly, we need to analyze the n ongoing traffic patterns along the time axis to locate the time interval where the new data transmission is allowed. Using this available time, new transmissions can be scheduled accordingly. The multi-link concurrency scheduling algorithm is described as follows.

Multi-link Concurrency Scheduling algorithm

- 1: $N \leftarrow 4n$
 - 2: Divide the time axis into N blocks according to different patterns at each time instance from n ongoing traffic information.
 - 3: **for** each block i **do**
 - 4: $D_i \leftarrow 0, A_i \leftarrow 0$
 - 5: Run function *DATA-Concurrency-Condition*
 - 6: **if** *conditiond* = *true* **then**
 - 7: $D_i \leftarrow 1$
 - 8: **end if**
 - 9: Run function *ACK-Concurrency-Condition*
 - 10: **if** *conditiona* = *true* **then**
 - 11: $A_i \leftarrow 1$
 - 12: **end if**
 - 13: **end for**
 - 14: Find the smallest T_1 at the time axis, for which there exist T_2 that satisfies:
 1. $T_2 - T_1 > T_{Frag} + SIFS + T_{ACK}$;
 2. when $T_1 < t < T_2 - T_{ACK} - SIFS$, $D_i = 1$;
 3. when $T_2 - T_{ACK} < t < T_2$, $A_i = 1$.
 - 15: **if** $T_{DATA} > T_2 - T_{ACK} - SIFS$ **then**
 - 16: Fragment $DATA_{n+1}$.
 - 17: **else**
 - 18: Aggregate $DATA_{n+1}$.
 - 19: **end if**
 - 20: Determine MCS for new transmission (MCS_n);
 - 21: Defer transmission til T_1 ;
 - 22: **if** new traffic on the channel before T_1 **then**
 - 23: Reset n ;
 - 24: Go to Step 1.
 - 25: **else**
 - 26: Transmit $DATA_{n+1}$.
 - 27: **end if**
-

According to different patterns at each time instance from n ongoing transmissions, time is divided into blocks so that the overall traffic from all the links on the channel during each block stays the same, as shown in Fig. G.4. The concurrency conditions of the new DATA and ACK packets are calculated separately for each time block. D_i and A_i are indicators of the permission of the Data and ACK transmission in each block i , respectively. For example, if the condition for new concurrent DATA transmission in block i is satisfied, D_i is set to 1. Otherwise, D_i is 0. The function *DATA-Concurrency-Condition* is described in the following chart. The other function *ACK-Concurrency-Condition* works in a similar way, but assumes the ACK transmission instead of the data packet transmission in the third step. Besides, no MCS selection is involved in *ACK-Concurrency-Condition*.

After determining if the new DATA or ACK transmission is supported in each time block, we need to find and allocate an appropriate time interval to the new traffic. Resource allocation and traffic scheduling itself is a challenging task, and beyond the scope of this paper. In this study, we allocate the first qualified time interval to the new transmission, as demonstrated in Step 14 of the scheduling algorithm. In the list of the criteria for the time interval in Step 14, T_{Frag} is the required minimum time interval for data concurrency, and T_{ACK} is the time duration used for ACK transmission. The first criteria indicates that if the available time interval is shorter than T_{Frag} , transmission concurrency is regarded as not worthwhile considering the overhead. T_{Frag} can be configured according to network requirements. The second criteria requires that the new data packet has to be supported for at least T_{Frag} , while the third one requires the support of ACK transmission one SIFS interval after the data transmission.

Thereafter, as shown in Steps 15 to 19, the DATA packet is fragmented or aggregated if necessary to fit in the time interval available to the new transmission. The highest order of MCS supported during the time interval is selected in Step 20. The AP node defers its transmission till T_1 and keeps carrier sensing. If there is no new traffic sent on the channel by the time T_1 , the new DATA will be sent according to the schedule. Otherwise, the AP needs to run the whole scheduling algorithm again and find a new time interval for its traffic.

V. PERFORMANCE EVALUATION

Function DATA-Concurrency-Condition

- 1: $conditiond \leftarrow \text{false}$, $MCSn \leftarrow 0$
- 2: **for** traffic No. 1 : n **do**
- 3: Calculate new SINR assuming $DATA_{n+1}$ on the channel.
- 4: **end for**
- 5: **if** SINR of all the n on-going packets is above their respective threshold and Eq. (3) is true with the lowest order MCS **then**
- 6: $conditiond \leftarrow \text{true}$
- 7: $MCSn \leftarrow$ the highest order of MCS that satisfies

$$\frac{\frac{P_{A_{n+1}} G_{A_{n+1}} G_{B_{n+1}} \lambda^2}{D_{A_{n+1} B_{n+1}}^\gamma (4\pi)^2}}{\sum_{i=1}^n \frac{P_{A_i} G_{A_i} G_{B_{n+1}} \lambda^2}{D_{A_i B_{n+1}}^\gamma (4\pi)^2} + N_0 W} > SNR_{th}(DATA_{n+1}) \quad (3)$$

- 8: **end if**
 - 9: **return** $conditiond$, $MCSn$
-

The proposed C^2SMA/CA scheme is implemented in MATLAB. The simulation parameters are set up using the IEEE 802.11g standard as a reference. The data length is set to be 1500 bytes. The ACK length is 14 bytes, and the duration of SIFS is $16 \mu\text{s}$. The transmitting power is set to 20 dBm, the antenna gains are set to 1, and the additive Gaussian noise power is -90 dBm. The adaptive MCS scheme and the corresponding SNR threshold value for each MCS to decode packets correctly, SNR_n^{th} , are given in Table G.2[12].

TABLE G.2: Modulation and Coding Scheme Set.

| | | | | |
|-------------------|---------|--------------|---------------|---------------|
| Data Rate | 6 Mbps | 9 Mbps | 12 Mbps | 18 Mbps |
| SNR_n^{th} (dB) | 6.02 | 7.78 | 9.03 | 10.79 |
| Scope (dB) | <7.78 | 7.78 ~ 9.03 | 9.03 ~ 10.79 | 10.79 ~ 17.04 |
| Data Rate | 24 Mbps | 36 Mbps | 48 Mbps | 54 Mbps |
| SNR_n^{th} (dB) | 17.04 | 18.8 | 24.05 | 24.56 |
| Scope (dB) | <18.8 | 18.8 ~ 24.05 | 24.05 ~ 24.56 | >24.56 |

We only consider path loss and Gaussian noise in our channel model. The backoff procedure is omitted in our implementation for the sake of simplicity. We assume no packets arrive at APs at exactly the same time. 1000 transmission trials with random network

topologies are made for each simulation setup. The network throughput performance is investigated considering different factors, such as number of concurrent links, network density, and uplink/downlink traffic ratio.

A. Influence of Number of Concurrent Links

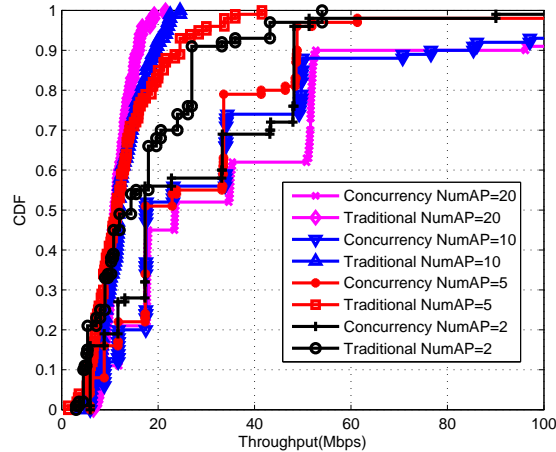

FIGURE G.5: Throughput CDF with Multiple Concurrent Links.

Different numbers of APs are randomly distributed in an area of $50 \text{ m} \times 50 \text{ m}$ with γ as 4. Fig. G.5 illustrates the throughput CDF of C^2SMA/CA in comparison with the original DCF scheme. The advantage of concurrency transmission over traditional transmission is clearly demonstrated. For example, with traditional transmissions, the throughput of 88 percent of the trials is below 23.4 Mbps and 99 percent is below 41.4 Mbps; whereas with concurrency transmissions, only 50 percent is below 23.4 Mbps and 80 percent is below 41.4 Mbps. A greater percentage of the simulations trials get higher throughput with more APs in the network, because of the higher probability of multiple concurrent transmissions.

For a clearer illustration, the average throughput performance is shown in Fig. G.6. The throughput gain of the concurrency scheme, defined as the throughput of C^2SMA/CA divided by the throughput of traditional CSMA/CA, is 1.8, 2.2, 3.02 and 3.3 when there are 2, 5, 10 and 20 APs in the network respectively. The improvement becomes less significant when the number of APs increases from 10 to 20. That is because that in a given channel condition, only a limited number of concurrent links can be supported. In

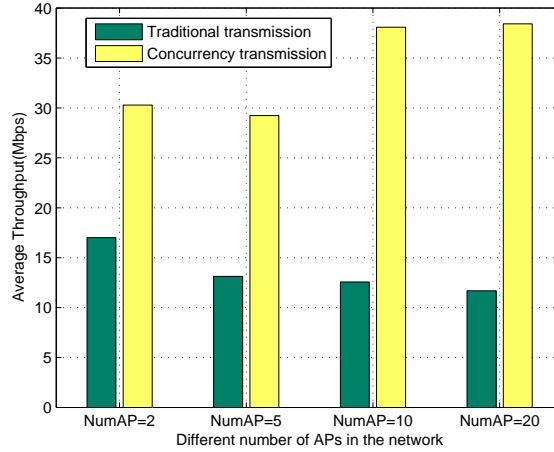

FIGURE G.6: Average Throughput Comparison with Multiple Concurrent Links.

a dense network, the number of concurrent links stays stable even when the number of APs increases.

B. Influence of Different Network Densities

The average throughput performance with different network densities is investigated in this subsection. 20 AP nodes are distributed randomly into dense, medium and sparse networks. The network configurations are listed below.

- Dense: 50 m \times 50 m, $\gamma = 4$, indoor environments;
- Medium: 200 m \times 200 m, $\gamma = 2.6$; semi-open environments;
- Sparse: 1000 m \times 1000 m, $\gamma = 2$, outdoor environments.

From the simulation results in Fig. G.7, it is obvious that the performance of C^2SMA/CA is highly dependent on network scenarios. In the dense network scenario, C^2SMA/CA can provide three times as high throughput as CSMA/CA does. However, the benefits of concurrent transmissions are less significant in our medium and sparse networks. The reason is that lower probability of concurrent transmissions exists in those networks. The results indicate that C^2SMA/CA might work most efficiently in densely distributed environments.

C. Influence of Asymmetric Uplink/Downlink Traffic

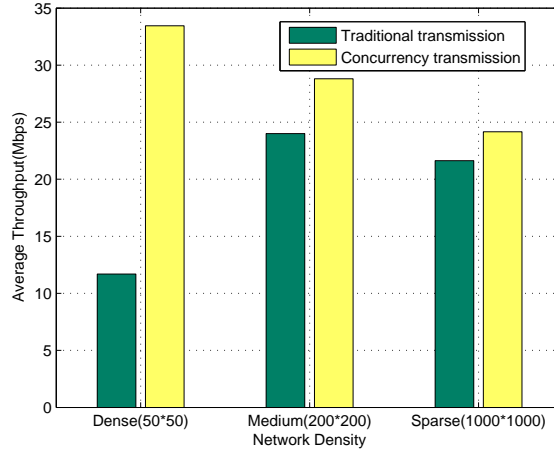

FIGURE G.7: Average Throughput Comparison with Different Network Densities.

The performance of C^2SMA/CA is affected by different ratios of uplink and downlink traffic stream since it only provides concurrency for the new downlink traffic from APs. The simulations are made in a dense network with 20 APs in an area of $50\text{ m} \times 50\text{ m}$. As shown in Fig. G.8, the average throughput of C^2SMA/CA decreases slowly as the ratio of downlink traffic decreases. In C^2SMA/CA , concurrent transmissions are only decided and initiated at APs where the necessary position and traffic information is available. Therefore, it is natural that the throughput decreases when less traffic is initiated from APs with a lower downlink traffic ratio. However, the probability of concurrent transmissions is still considerable since there are 20 APs in the network. Even with an equal ratio of uplink/downlink traffic, the performance improvement in Fig. G.8 is still significant. Remarkable performance gains are expected with C^2SMA/CA in real WLAN scenarios, since the downlink traffic is dominant in most Wi-Fi applications.

VI. CONCLUSIONS AND FUTURE WORK

In this paper, we have proposed C^2SMA/CA , a concurrency transmission scheme in infrastructure WLANs using the position information supplied by cooperative carrier sensing of multi-element antenna at APs. From the simulation results, C^2SMA/CA clearly demonstrates its advantage over its legacy counterpart. Better performance is achieved with more concurrent links. In a dense network, three times as high throughput is provided with C^2SMA/CA compared with traditional CSMA/CA. The benefits are still significant when there is more uplink traffic in the network.

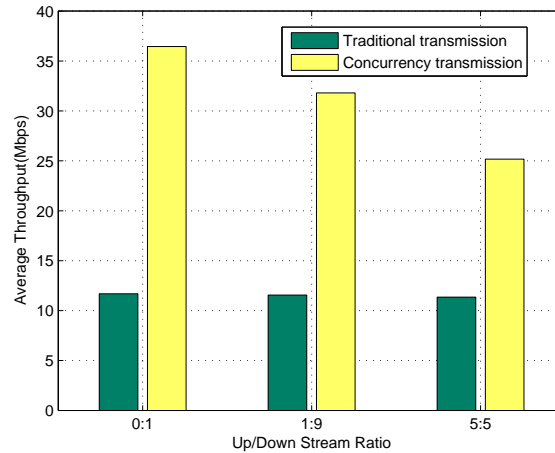

FIGURE G.8: Average Throughput Comparison with Different Uplink/Downlink Traffic Ratio.

In this work, we assumed perfect distance estimation from positional carrier sensing. However, the accuracy of the estimation is dependent on the number of the antenna elements at APs. In our future work, we will take impairments from inaccurate position estimations as well as imperfect channel estimation into consideration.

References

- [1] IEEE Std. “IEEE 802.11: Wireless LAN Medium Access Control (MAC) and Physical Layer (PHY) Specifications”, *IEEE-SA*, June 2007. doi:10.1109/IEEESTD.2007.373646.
- [2] P. Karn, “MACA- A New Channel Access Method for Packet Radio”, *Proc. of the 9th ARRL Computer Networking Conference*, vol. 140, pp. 134-140, Sept. 1990.
- [3] S. Lakshmanan, K. Sundaresan, M. Khojastepour, and S. Rangarajan, “Practical Multi-antenna Spatial Reuse in WLANs”, *Proc. of Conference on Broadband Communications*, pp. 1- 20, Oct. 2010.
- [4] P. Karn, “Improving Spatial Reuse in Multihop Wireless Networks - A Survey”, *IEEE Communications Surveys & Tutorials*, no. 3, vol. 11, pp. 71-91, Aug. 2009.
- [5] G. Judd, “Using Physical Layer Emulation to Understand and Improve Wireless Networks”, *PhD thesis Carnegie Mellon University*, CMU-CS-06-164, Oct. 2006.

- [6] M. Takai, J. Martin, A. Ren, and R. Bagrodia, “Directional Virtual Carrier Sensing for Directional Antennas in Mobile Ad Hoc Networks”, *Proc. of ACM Mobihoc*, pp. 183-193, June 2002.
- [7] K. Mittal and E. M. Belding, “RTSS/CTSS: Mitigation of Exposed Terminals in Static 802.11-Based Mesh Networks”, *Proc. of IEEE WiMesh Workshop*, pp. 3-12, Sept. 2006.
- [8] M. Vutukuru, K. Jamieson, and H. Balakrishnan, “Harnessing Exposed Terminals in Wireless Networks”, *Proc. of the 5th Symposium on Networked Systems Design and Implementation*, pp. 59-72, Aug. 2008.
- [9] S. Kim, J. Cha, and J. Ma, “Design and Theoretical Analysis of Throughput Enhanced Spatial Reuse Distributed Coordination Function for IEEE 802.11”, *IET Communications*, no. 12, vol. 3, pp. 1934-1947, Dec. 2009.
- [10] S. Lakshmanan, C. L. Tsao, and R. Sivakumar, “On Coding Concurrent Transmissions in Wireless Networks”, *ACM SIGMOBILE Mobile Computing and Communications Review*, no. 2, vol. 14, pp. 4-6, April 2010.
- [11] IEEE Std. “IEEE 802.11n-2009–Amendment 5: Enhancements for Higher Throughput”, *IEEE-SA*, Oct. 2009. doi: 10.1109/IEEESTD. 2009.5307322.
- [12] K. Ramachandran, R. Kokku, H. Zhang, and M. Gruteser, “Symphony: Synchronous Two-Phase Rate and Power Control in 802.11 WLANs”, *IEEE/ACM Transactions on Networking*, no. 4, vol. 18, pp. 1289-1302, Feb. 2010.

