

SURVEY

Low-Power Wide-Area Networks: A Broad Overview of Its Different Aspects

NAGA SRINIVASARAO CHILAMKURTHY¹, OM JEE PANDEY², (Senior Member, IEEE), ANIRBAN GHOSH¹, LINGA REDDY CENKERAMADDI³, (Senior Member, IEEE), AND HONG-NING DAI⁴, (Senior Member, IEEE)

¹Department of Electronics and Communication Engineering, SRM University AP, Vijayawada, Andhra Pradesh 522240, India

²Department of Electronics Engineering, IIT BHU Varanasi, Varanasi, Uttar Pradesh 221005, India

³Department of Information and Communication Technology, University of Agder, 4879 Grimstad, Norway

⁴Department of Computer Science, Hong Kong Baptist University, Hong Kong

Corresponding author: Linga Reddy Cenkeramaddi (linga.cenkeramaddi@uia.no)

This work was supported by the Science and Engineering Research Board (SERB), Government of India, through the Start-Up Research Grant Award Scheme Project “Design and Development of Cognitive Small-World LPWANs for Internet of Things towards Health Monitoring” (duration 2022-2024), under Grant SRG/2021/000137. This work was also partially supported by the Indo-Norwegian Collaboration in Autonomous Cyber-Physical Systems (INCAPS) project: 287918 of the International Partnerships for Excellent Education, Research and Innovation (INTPART) program and the Low-Altitude Unmanned Aerial Vehicle (UAV) Communication and Tracking (LUCAT) project: 280835 of the Information and Communications Technology and Digital Innovation (IKTPLUSS) program from the Research Council of Norway.

ABSTRACT Low-power wide-area networks (LPWANs) are gaining popularity in the research community due to their low power consumption, low cost, and wide geographical coverage. LPWAN technologies complement and outperform short-range and traditional cellular wireless technologies in a variety of applications, including smart city development, machine-to-machine (M2M) communications, healthcare, intelligent transportation, industrial applications, climate-smart agriculture, and asset tracking. This review paper discusses the design objectives and the methodologies used by LPWAN to provide extensive coverage for low-power devices. We also explore how the presented LPWAN architecture employs various topologies such as star and mesh. We examine many current and emerging LPWAN technologies, as well as their system architectures and standards, and evaluate their ability to meet each design objective. In addition, the possible coexistence of LPWAN with other technologies, combining the best attributes to provide an optimum solution is also explored and reported in the current overview. Following that, a comparison of various LPWAN technologies is performed and their market opportunities are also investigated. Furthermore, an analysis of various LPWAN use cases is performed, highlighting their benefits and drawbacks. This aids in the selection of the best LPWAN technology for various applications. Before concluding the work, the open research issues, and challenges in designing LPWAN are presented.

INDEX TERMS Low-power wide-area networks, wireless networks, Internet of Things, design objectives, network topology, architecture, applications.

I. INTRODUCTION

The Internet of Things (IoT) has the potential to change the way we live and work by providing its essential services to all the smart devices which are connected to it. IoT alleviates various challenges of wireless networks such as robust internet connectivity among a large population of

The associate editor coordinating the review of this manuscript and approving it for publication was Yu-Huei Cheng¹.

smart devices, energy constraints in mobile edge devices, fast data transfer, efficient bandwidth utilization, and increased data gathering capability/reliability at the receiver. To achieve these goals, the devices must be optimally connected to the network, resulting in a fast exchange of sensed data facilitating intelligent decision-making to control the physical world phenomenon yielding a smart ecosystem. Several independent studies have predicted that in coming years IoT plays a crucial role in various social and commercial

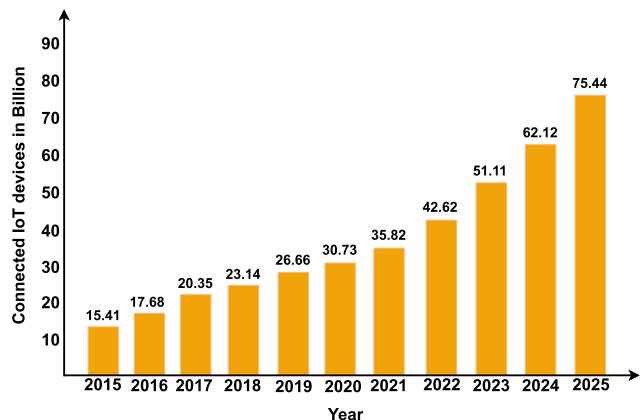

FIGURE 1. An illustration of the growth of IoT devices during the years 2015 and 2025 [6].

applications such as smart healthcare, intelligent transportation, climate-smart agriculture, rescue operations, logistics, smart cities, industries, utilities, smart buildings, consumer electronics, security, asset tracking, smart waste management systems, cognitive manufacturing, and Machine-to-Machine (M2M) communications [1]–[5]. Furthermore, it has been estimated that by 2025, the adoption of smart M2M gadgets and electronic goods can overtake the number of human subscribers utilizing smartphones, desktops, notebooks, and similar objects. According to the analysis of the Statista Research Department (SRD), there will be more than 75 billion connected devices as shown in Fig. 1 [6]. Among them, there are connected cars, machinery, mobile devices, sensors, point-of-sale terminals, consumer electronic items, wearables, and other IoT gadgets.

To support IoT, several wireless technologies have emerged, such as short-range Wireless Sensor Networks (WSNs) and long-range cellular networks. Wireless technologies such as Near Field Communication (NFC), Radio Frequency Identification (RFID), Bluetooth Low Energy (BLE), Z-wave, Wireless Local Area Networks (WLANs), and IPv6 Low Power Wireless Personal Area Networks (6LoWPANs) fall in the category of short-range wireless technology for IoT. However, short-range wireless technologies for IoT networks face various challenges including reduced network scalability, poor network robustness, and increased network deployment cost. On the other hand, the cellular network-based IoT suffers from high network infrastructure complexity, more network deployment cost, and reduced network lifetime. For instance, traditional mobile communication technologies (e.g., Second Generation (2G), Third Generation (3G), and Fourth Generation (4G)) need more infrastructures for their deployment, where the battery life of devices is quite low whereas in the case of short-range technology the scalability may be limited by the number of nodes that can remain connected to a single node. The aforementioned challenges of short-range and long-range wireless communication technologies for IoT applications make the emergence of Low-Power Wide-Area Networks (LPWANs)

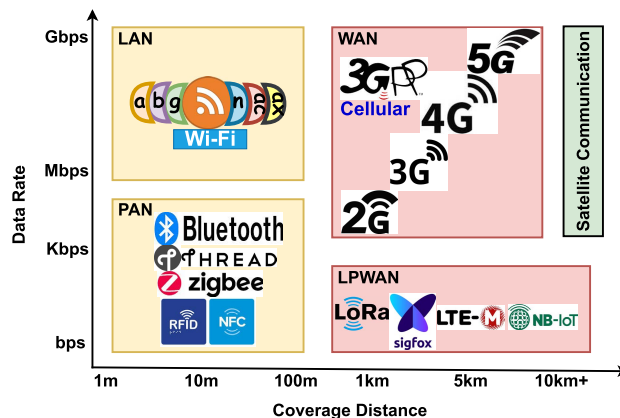

FIGURE 2. A comparative analysis of various wireless technologies used for IoT applications.

more relevant [7]. A comparative study of various short-range and long-range wireless communication technologies used for IoT applications is given in Fig. 2.

LPWAN is a popular and leading wireless Wide Area Network (WAN) technology that meets the vision of IoT by exhibiting low power consumption, providing wide-area coverage, utilizing bandwidth efficiently, and requiring low network deployment costs. Fig. 3 compares the energy efficiency and implementation costs of several wireless communication systems. LPWAN appears to be the best option, with the lowest deployment cost and highest energy efficiency. LPWAN-based M2M connectivity allows IoT devices to perceive and interact with the environment from anywhere at any time. LPWAN on average supports up to 40 km of wide coverage in rural areas (good Line of Sight (LoS)) and 10 km in urban areas (poor LoS), with a minimum battery life of 10 years [8]. In addition, it requires an average cost of less than \$5 per device, less than \$1 network maintenance per device per year [9], but requires a higher response time (typically in seconds or minutes). Several technologies come under the umbrella of LPWAN like Long Range (LoRa), SigFox, Narrowband-IoT (NB-IoT), Long Term Evolution for Machines (LTE-M), Ingenu, Telensa, DASH7, Extended Coverage Global System for Mobile Communication (EC-GSM), Weightless-N, Weightless-P, Weightless-W, IEEE 802.15.4k, and IEEE 802.15.4g, (802.15.4 is a Low Rate Wireless Personal Area Network) (LR-WPAN) [10].

Even though all the above technologies utilize the same working principle, they differ from each other in perspectives of implementation and behavior. Some of the technologies are based on proprietary software or hardware while others are open to modifications. For the execution of respective protocols, some of the above technologies employ GSM bands, while others use unlicensed Industrial Scientific Medical (ISM) radio channels. Many of the protocols used to implement these technologies allow users to add their base stations, while others provide operator services. These technologies not only differ in terms of technical details

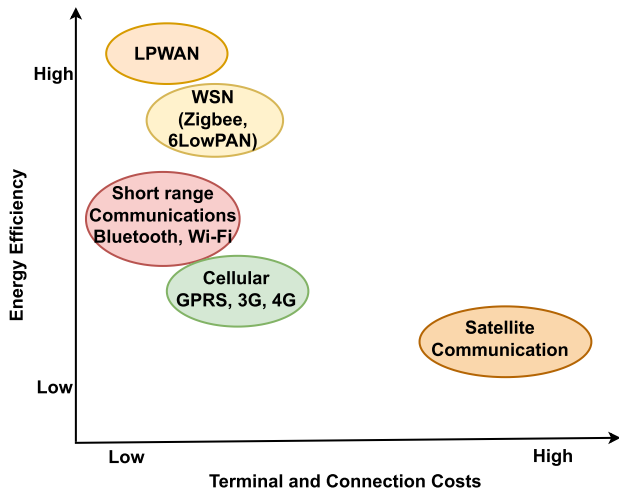

FIGURE 3. Comparison of energy efficiency with terminal and connection cost of various wireless communication technologies [11].

but also in commercial models [12]. In addition, because of these differences among the technologies, they differ in many aspects like frequency of operation, range of coverage, data rate, energy consumption, latency, and choice of modulation. The licensed LPWAN technologies (NB-IoT, LTE-M, etc.) are efficient in terms of Quality of Service (QoS), reliability, latency, and range, whereas unlicensed technologies (LoRa, SigFox, etc.) excel in terms of battery lifetime, network capacity, and cost [13]. Therefore, depending on the requirements, a suitable LPWAN technology is chosen for the deployment of IoT applications. Additionally, the novel algorithms developed in the context of blockchain technology, Artificial Intelligence and Machine Learning (AI & ML), and data analytics are expected to further augment the development of LPWANs.

There are several review articles on LPWAN as listed in Table 1, and a few of them focused on different LPWAN technologies and compared their design objectives while others described network architectures, use cases, and challenges of LPWAN implementation. However, to the best of our knowledge, this is the first novel attempt to provide a complete overview of the different aspects of LPWAN with useful insights. Our objective in this review article is to provide an overarching description of LPWAN in terms of design goals, techniques to improve design objectives, and system architecture. In addition, we also provide a complete evaluation of several existing and non-standardized LPWAN technologies and the market opportunities of LPWAN, as well as a guide for researchers to choose the best LPWAN technology for their application. Table 1 lists the contribution of each review paper and its limitations.

The rest of the paper is laid out as follows: Section II explains how several distinct tactics are employed to meet the design objectives. Section III discusses LPWAN topologies, architectures, and their interoperability. Section IV explores a variety of LPWAN solutions that use both licensed and

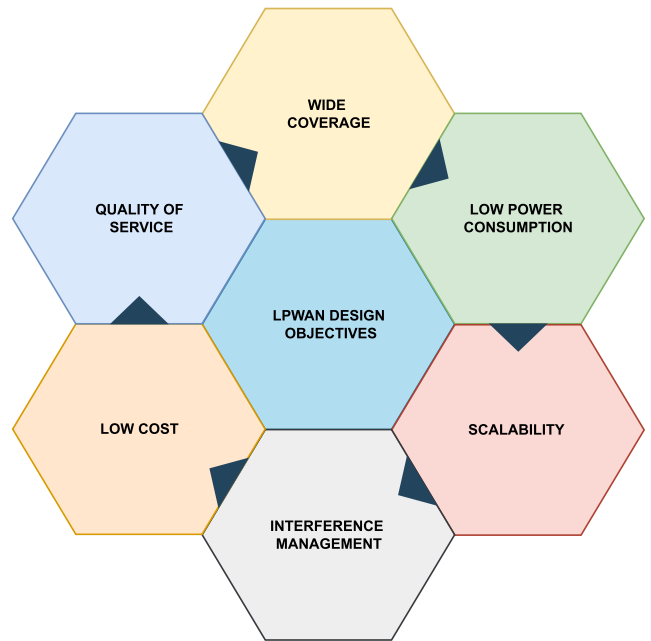

FIGURE 4. LPWAN design objectives.

unlicensed bands. Section V examines the suitability of different LPWAN technologies to the design objectives enlisted earlier in Section II. The commercial and infrastructural costs of different LPWAN technologies are elaborated in Section VI. Section VII suggests LPWAN technology for a variety of IoT applications. Section VIII identifies the major issues in LPWAN technologies and provides directions for the future. Finally, the paper concludes in Section IX.

II. DESIGN OBJECTIVES AND EXISTING METHODOLOGIES

To support the exponential growth of IoT devices, several wireless technologies have emerged. Each of these wireless technologies suffers from various challenges such as network scalability, coverage, robustness, energy efficiency, QoS, and deployment cost. LPWAN addresses the aforementioned challenges and provides essential services to IoT devices. With this motivation, in this section, we elaborate on the design objectives of LPWAN along with the methodologies used to achieve these design goals. Subsequently, the design objectives of LPWAN have also been illustrated in Fig. 4.

A. WIDE COVERAGE

One of the key features of LPWAN is its capacity to transfer data from individual devices across large distances, resulting in LPWANs long-range transmission capability. Most of the unlicensed LPWAN technologies (LoRa, SigFox, DASH7) are operated under ISM sub-GHz band frequencies (e.g 868 MHz and 915 MHz). The range of coverage is inversely proportional to the frequency of operation. Low frequency signals under sub-GHz will have high propagation through obstacles and concrete walls compared to high frequency

TABLE 1. Literature Survey on existing LPWAN review papers and the identified gaps.

S.No	Title of the paper	Contribution of the paper	Limitations/Gaps Identified in the paper
1	Low power wide area networks: An Overview [9].	Explained the design objectives, Proprietary technologies, Applications, and Challenges.	Architectural point of view, Impact of design decisions on LPWAN design goals, new emerging LPWAN Technologies, and Market opportunities.
2	A Comparative study of LPWAN Technologies for large-scale IoT deployment [14].	Compared different LPWAN technologies and addressed the applications of LPWAN.	Design objectives, Impact of design decisions on LPWAN design goals, Architectural explanation, new emerging technologies, and Challenges.
3	Low Power Wide Area Networks: A Survey of enabling Technologies, Applications, and Interoperability Needs [11].	Explained different LPWAN technologies, Applications, and Challenges of LPWAN.	Design objectives, Impact of design decisions on LPWAN design goals, Architectural point of view, new emerging technologies.
4	Long Range Wireless Technologies: A Survey [12].	Explained about different LPWAN technologies and how to select the best appropriate LPWAN technology for the desired application.	Design objectives, Architectural explanation, new emerging technologies, LPWAN market opportunities, Applications, and Challenges.
5	Low Power Wide Area Networks for Internet of Things: A Comparative Review [13].	The performance of LPWAN technologies for IoT, as well as their design goals and implementations, were investigated.	Design objectives, Architectural explanation, new emerging technologies, LPWAN market opportunities, Applications, and Challenges.
6	LPWAN Technologies: Emerging Application Characteristics, Requirements, and Design Considerations [15].	LPWAN Application requirements and their characteristics, Design Objectives, generalized LPWAN architecture model, and LPWAN technologies.	Impact of design decisions on LPWAN design goals, Specifications of LPWAN technologies, LPWAN market opportunities, and Challenges.
7	Overview of Cellular LPWAN technologies for IoT deployment: SigFox, LoRaWAN, and NB-IoT [16].	Compared LoRaWAN, SigFox, and NB-IoT technologies and addressed the applications of LPWAN.	Design objectives, Impact of design decisions on LPWAN design goals, Architectural explanation, new emerging technologies, LPWAN market opportunities, and Challenges.
8	Low Power Wide Area Networks: Design goals, architecture, suitability to use cases, and research challenges [17].	Design objectives, Impact of design decisions on LPWAN design goals, LPWAN architectures specifications, and Challenges.	Generalized Network topology and Architectural view, New emerging technologies, LPWAN market opportunities, and impact of design decisions towards LPWAN QoS.
9	Survey on 3GPP Low Power Wide Area Technologies and its Application [18].	Compared different LPWAN technologies in terms of application point of view.	Design objectives, Architectural explanation, new emerging technologies, LPWAN market opportunities, and Challenges.
10	A Survey on LPWAN Technology: LoRa and NB-IoT [19].	Compared LoRa and NB-IoT technologies in terms of their design goals and applications.	Design objectives, Architectural explanation, new emerging technologies, LPWAN market opportunities and Challenges.
11	Low Power Wide Area Networks: Opportunities, Challenges and Directions [20].	Explained LPWAN design goals, Technologies, Applications, and Challenges.	Architectural explanation, new emerging technologies, Comparison among LPWAN technologies, and LPWAN market opportunities.
12	A Survey of Low Power Wide Area Network Technologies [21].	Compared LoRaWAN, SigFox, and NB-IoT technologies.	Design objectives, Impact of design decisions on LPWAN design goals, Architectural explanation, new emerging technologies, LPWAN market opportunities and Challenges.
13	Towards Energy-efficient NB-IoT: A Survey on evaluating its suitability for smart applications [22].	Compared NB-IoT with a few LPWAN technologies and proposed a model for smart agriculture using NB-IoT.	Design objectives, Impact of design decisions on LPWAN design goals, Architectural explanation, new emerging technologies, LPWAN market opportunities, Applications, and Challenges.
14	A Survey of LPWAN technology in Agricultural field [23].	Compared different LPWAN technologies used in the agriculture field.	Design objectives, Architectural explanation, new emerging technologies, LPWAN market opportunities, Applications, and Challenges.
15	A Survey on LoRa networking: Research Problems, Current Solutions and Open Issues [24].	Explained the brief technical background of LoRa including research problems with solutions and open challenges.	Architectural point of view, LPWAN market opportunities, new emerging technologies comparison, and Applications.
16	A Survey on the security of Low Power Wide Area Networks: Threats, Challenges, and Potential Solutions [25].	Explained LPWAN security analysis including different LPWAN technologies and open research challenges related to security in the network.	Design objectives, Generalized network topology and architectural view, new emerging technologies, LPWAN market opportunities, and applications.
17	A Review of Energy Harvesting Techniques for LPWANs [26].	Explained different energy harvesting techniques for LPWAN including different LPWAN technologies and comparison among them.	LPWAN Design goals, Architectural view, new emerging technologies, market Opportunities, Applications, and Open research challenges.
18	A Survey on Adaptive data rate optimization in LoRaWAN: Recent solutions and major challenges [27].	Different Adaptive Data rate methods are proposed and the impact of ADR schemes on the performance of LoRaWAN is discussed.	Design objectives, Architectures, LoRa Classes of operation, comparison with other LPWAN technologies, applications, challenges, and market opportunities
19	Internet of Things and LoRa Low power Wide Area Networks: A Survey [28].	Explained IoT requirements and challenges, including brief description of LoRaWAN.	LPWAN Design goals, Architectural view, new emerging LPWAN technologies, LPWAN market Opportunities, Applications, and open research challenges.
20	A Survey of two Dominant Low Power and Long Range Communication Technologies [29].	Compared the performance of LoRaWAN and NB-IoT in the context of IoT parameters.	LPWAN Design goals, Architectural view, new emerging LPWAN technologies, LPWAN market Opportunities, Applications, and open research challenges.
21	A Survey of 5G Emerging Wireless Technologies Featuring LoRaWAN, SigFox, NB-IoT, and LTE-M [30].	Explained how LoRaWAN, SigFox, NB-IoT, and LTE-M can be applied for 5G Communication and compared their technical specifications.	LPWAN Design goals, Architectural view, new emerging LPWAN technologies, LPWAN market Opportunities, Applications, and open research challenges.
22	A Comparative Survey Study on LPWA IoT Technologies: Design Considerations, Challenges, and Solutions [31]	Explained LPWAN Design objectives, few LPWAN Technologies, and Challenges	Architectural view, Impact of design decisions on LPWAN design objectives, New Emerging LPWAN Technologies, LPWAN Market Opportunities, and Applications.

signals. In contrast to cellular systems, LPWAN technologies provide a gain of +20 dB [32]. This targeted gain connects the end devices to the base station from one kilometer (km) to ten kms based on the type of environment (urban or rural) [9]. As a result, to achieve long-range connectivity, wireless devices operate at frequencies in the sub-GHz spectrum and employ some unique modulation algorithms, as described below.

1) OPERATING UNDER SUB-GHz BAND

A sub-GHz radio's narrow band functioning allows data transmission over long ranges. This enables sub-GHz nodes to interact directly with a remote hub instead of hopping from one node to another, as is commonly the case with a 2.4 GHz system. There are three main reasons why sub-GHz applications outperform 2.4 GHz applications in terms of range: (i) because attenuation inflation rises with higher

frequencies, the 2.4 GHz signal fades faster than a sub-GHz signal, (ii) the 2.4 GHz transmission can deteriorate quickly in densely populated areas, lowering signal quality, and (iii) the angle of diffraction increases as the frequency decreases, enabling sub-GHz transmissions to bend more around an obstruction and reduce the blocking impact.

2) MODULATION TECHNIQUES

To enable long-distance data transmission (usually from a few hundred meters to kms), LPWAN technologies are designed to achieve a link budget of 150 ± 10 dB in rural and urban areas, respectively [9]. A trade-off between data rate and modulation rate in the physical layer provides the transmitted bit (or symbol) with additional energy. As a result, receivers can correctly sense signals that have been significantly attenuated. The usual sensitivity of modern LPWAN receivers is -130 dBm. To support long-range connectivity, various LPWAN technologies use narrowband and spread spectrum modulation techniques that can offer larger link budgets and are elaborated below.

These modulation schemes efficiently split the entire spectrum into numerous bands by allocating each carrier a very small band. The noise level inside a single narrowband is typically very small. As a result, there is no need for frequency de-spreading processing gain in the receiver to decode the signal, resulting in a simple and low-cost transceiver architecture that can yield long-range data transmission. NB-IoT and Weightless-P are the two LPWAN technologies that preferably use narrowband modulation techniques [16].

Ultra Narrow Band (UNB) uses an ultra-narrow frequency channel to provide an ultra-long-distance link between transmitter and receiver (less than 1 kHz). It provides a great link budget due to power concentration in a restricted frequency band and reduced in-band received noise (narrow receive filters remove most of the noise). As a result, it provides long-range coverage with minimal transmit power, making it an ideal LPWAN technology for Industrial-IoT (IIoT) devices. Furthermore, its ultra-high Power Spectral Density (PSD) provides resistance to interference and jamming, allowing UNB to coexist in shared frequency bands in a friendly manner. LPWAN systems like SigFox, Weightless-N, and Telensa use UNB modulation techniques for supporting long-range connectivity [33].

Spread Spectrum (SS) is a technology for IIoT systems that use wideband (noise-like signals) to transport data and spreads the data signal over a considerably wider bandwidth than the actual bandwidth of the data signal. Unlike narrowband, where data is conveyed over a single RF band, data in SS is transmitted by switching carrier frequencies or changing the data pattern continually. Narrowband transmitters and SS transmitters use the same transmit power level. Because SS signals are wider than narrowband signals, they can transmit at a lower PSD (W/Hz) than narrowband transmitters. This is one of the most significant advantages of SS, as well as one of the reasons for achieving long-range connectivity in low-power IoT devices. Table 4 and Table 5

in Section IV summarize the type of modulation techniques preferred by different LPWAN technologies.

B. ULTRA LOW POWER OPERATION

IoT devices are projected to last for a longer time (10 years or more) without the need for battery replacement. LPWAN technology supports this requirement by enabling low power operations over IoT devices [26]. According to [12], utilization of AA or coin cell batteries reduces device maintenance costs. Additionally, it helps in improving the energy efficiency of the devices. Network topology, duty cycle, lightweight Medium Access Control (MAC) protocols, and offloading complexity from end devices are some of the major factors in achieving low power operation for the IoT devices [9], which are discussed below.

1) NETWORK TOPOLOGY

Star and mesh are the two prominent topologies used for LPWAN development. Most of the LPWAN technologies prefer the star topology [16], in which the end devices are directly connected to the base station. A base station that is always powered on offers convenient and immediate access to end devices at the cost of higher power usage by the end devices. On the other hand, in mesh topology using multi-hop data routing framework the end devices require less power for data transmission [34], at the cost of lower reliability and higher latency. The detailed descriptions of LPWAN topologies and their architectural representations are explored in Section III.

2) DUTY CYCLE

The power-hungry components of M2M/IoT devices are turned off to achieve low-power implementation. When LPWAN end devices are not in use, they can switch off their transceivers. The transceiver is only turned on when data has to be sent or received [3]. In addition to transceivers for low-power embedded networks, such techniques are extended to other components as well to further save on power. Individual hardware components (such as auxiliary components, storage, and microcontrollers) may be turned on or off using a modular hardware design. LPWAN application developers can reduce power usage and extend battery life by implementing these power management approaches. Duty cycling the data transceiver is not only a power-saving measure but also a legal obligation in the area of LPWAN technologies [17].

3) LIGHTWEIGHT MEDIUM ACCESS CONTROL PROTOCOL

Carrier Sense Multiple Access with Collision Avoidance (CSMA/CA) is a widely used MAC protocol in WLANs and other short-range wireless networks. The number of devices per base station is restricted in these networks, which eliminates the problem of hidden nodes. However, as the number of devices in LPWANs increases, carrier sensing is much less effective and more expensive at identifying ongoing transmissions, affecting the performance

of the network. Although the Request to Send/Clear to Send (RTS/CTS) mechanism is used to overcome this problem, it adds to the uplink and downlink communication overhead. LPWAN technologies cannot normally afford this much signaling overhead because of the enormous number of devices connected. Furthermore, virtual carrier sensing is limited due to link asymmetry, which is a feature of many LPWAN technologies today. To address the issue, ALOHA, a random access MAC protocol [35], is used by several LPWAN technologies, including Long Range Wide Area Network (LoRaWAN) and SigFox, where end devices broadcast without carrier detection. ALOHA's simplicity is intended to keep transceiver design simple and inexpensive.

4) OFFLOADING END DEVICE COMPLEXITY

The majority of technologies make the design of the end devices simpler by relegating resource-intensive activities to base stations or the backend system. Base stations usually employ hardware diversity to send and receive data from various end devices at the same time using different channels or orthogonal signals. Such a scheme simplifies the transmission of data from the end devices to the base station. In addition, the backend system is built to handle the bulk of the processing and computation, which further provides the end devices with robust and energy-efficient last-mile communication.

C. LOW COST

The commercial success of LPWANs is dependent on their ability to link a large number of end devices by using inexpensive hardware and providing connectivity at a lower subscription [14]. LPWAN can even be adopted favorably in applications where cellular networks and short-range wireless communication technologies are already well-established. Both end-users and network operators can benefit from using LPWAN technologies since it has lower capital and operating expenditure. Several strategies to enable the low-cost design of end devices for LPWAN development are proposed in the literature and they are elaborated below.

1) STRATEGIC USE OF LICENSED OR LICENSE-FREE BANDS

Both licensed and unlicensed band technologies have their own way of reducing the cost. Generally, the consequence of using licensed spectrum in new LPWAN technologies conflicts with the desired requirements of inexpensive implementation such as low-cost deployment, speedy market entry, and cost-effective solutions to customers. As a result, most LPWAN solutions are investigated using license-exempt bands like the ISM band or Television-White Spaces (TV-WS) for deployment. However, licensed band technologies, such as NB-IoT, a 3rd Generation Partnership Project (3GPP) LPWAN standard may share cellular bands and infrastructure that are currently controlled by Mobile Network Operators (MNOs) to eliminate the extra cost of licensing and deployment paving the way for an economical deployment.

2) REDUCTION IN HARDWARE COMPLEXITY

LPWAN transceivers typically process less complex waveforms than cellular and short-range wireless systems. It allows them to reduce the size of the transceiver, maximum data rates, and storage capacities, reducing hardware overhead and, as a result, the device cost. Manufacturers of LPWAN chips are aiming for a high number of connected end devices while simultaneously lowering costs through economies of scale.

3) MINIMUM INFRASTRUCTURE

To support long-distance data transmission traditional wired and wireless communication technologies require costly infrastructure deployment (gateways, power lines, relay nodes, and so on). On the other hand, the network infrastructure required for the LPWAN is small because each LPWAN access point/base station can support millions of end nodes over a distance of several kms, saving on network deployment costs.

D. SCALABILITY

One of the major design objectives of LPWAN is scalability, where an increase in the number of devices connecting to the existing network will not disturb the network performance. As the end devices in LPWAN are constrained in power, the gateways or base stations will play a key role in scaling up the network. Various strategies for improving the scalability of an LPWAN are further discussed below.

1) DIVERSITY TECHNIQUES

It's vital to make efficient use of bandwidth, time, space, and hardware to serve as many connected devices as feasible. As the end devices are inexpensive and constrained in power, LPWANs rely heavily on cooperation from more powerful components such as base stations and backend systems. To support parallel transmission and interference-resistant communication between devices, LPWAN solutions make use of multiple channels and antennas.

2) ADAPTIVE CHANNEL SELECTION AND DATA RATE

Deploying a huge number of sensor nodes and base stations alone cannot improve network scalability. Efficient link monitoring and adaptive channel selection will also play a key role in supporting network scalability. This can be achieved by adapting efficient modulation techniques, selecting better channels to reliably cover long distances, and performing dynamic transmission power control. To address the aforementioned requirements, the research community in the field of LPWAN has introduced new techniques which are elaborated on below.

The INTER-HARE protocol, which is based on concurrent multi-band IoT technologies and uses an 868 MHz LPWAN as a transparent backhaul for a group of 2.4 GHz sub-networks, can improve LPWAN scalability [36]. Improved coverage and scalability can be obtained by

combining numerous LPWANs [37]. Sensor Network Over White (SNOW) spaces, a newly suggested LPWAN design over TV-WS, have exhibited performance and energy efficiency improvements over conventional LPWANs. The authors in [37], proposed scaling up LPWANs by integrating numerous SNOWs in a seamless manner, allowing concurrent inter-SNOW and intra-SNOW communications. In [38], the authors described an appropriate selection of Spreading Factors (SF) which lead to improved network scalability.

Scalability has an impact on many parameters and various trade-offs need to be considered among MAC protocols, cost, low power, reliability, and duty cycle [36]. We further explore scalability as a potential future research challenge in Section VIII.

E. INTERFERENCE MANAGEMENT

Many LPWANs rely on the unlicensed ISM spectrum since licensed frequency bands are quite expensive. Although the utilization of the free ISM band saves money, it results in poor data gathering reliability due to interference. Interference in LPWANs can be categorized into internal and external. Internal interference occurs by the nodes in the network transmitting in the same or overlapping frequency band at the same time. This is frequently mitigated by channel access techniques and with the scalability design objective [17]. On the other end, external interference is a major issue because frequencies in the ISM band cannot be reserved. Due to an increase in the number of wireless networks, the ISM band has become more congested. To solve this problem, LPWANs operating in the ISM band frequency should be highly noise-resistant. Different optimization techniques for interference management are listed as follows,

1) COGNITIVE RADIO

When there is persistent interference in the spectrum, the cognitive radio comes into play. It monitors the environment, identifies interference, and adjusts network parameters to transfer communications to a less congested band of the spectrum while continually monitoring the interference in the new band [39].

2) SPATIAL SIGNAL PROCESSING

Spatial signal processing can be used to eliminate interference from a variety of sources, including advanced signal processing algorithms utilized by mobile transmitters. The main benefit of applying spatial signal processing is that it may be used to remove interference from prolonged bursts of transmission (of several milliseconds or more) that emerge on the channel [40]. The network's uplink and downlink Signal-to-Noise Ratio (SNR) can be improved by using spatial signal processing.

3) BAND STEERING

Since certain LPWANs use the ISM bands of 2.4 GHz frequency, they experience congestion and interference from widespread deployment of other technologies in the

unlicensed band. Band steering can be used to shift communication from 2.4 GHz to 5.0 GHz frequencies, or vice versa, reducing congestion and overload. As the communication shifts from 2.4 GHz to 5.0 GHz, from a congested to a less congested band, the band steering takes into account path loss adjustments [41].

4) MULTIPLE BASE STATIONS

Multiple base stations, improve the Data Extraction Rate (DER) of specific sensor nodes, to avoid interference. Because of deploying several base stations, the signal strength produced by these base stations will be strong at the receiver end [42]. As the concentration of the base stations increases, it can cater to more nodes in a location and hence to a larger network.

5) SMART ANTENNA TECHNOLOGY

The smart antenna works on the principle of directing most of the energy from transmitted signals to a single receiver, resulting in improved SNR of the received signal [43]. The use of various features of the received signal, as well as the effective control of the received and transmitted power, will aid in interference mitigation [44], [45].

F. QUALITY OF SERVICE

LPWAN technologies are targeting a diverse set of applications with varying requirements. On one end, it caters to delay-tolerant applications like smart metering, on the other end it should deliver the alarms in the minimum time generated by home security applications [46]. However QoS is not related to a single parameter, it is a combination of throughput, latency, jitter (variance in latency), and error rate [31], [47]. Balancing all these parameters leads to obtaining better QoS. Following are some of the possible ways to improve the QoS as found in the literature.

In [46], the authors find optimal settings of radio parameters such as SF and Carrier Frequency (CF) in LoRa networks using a Mixed Integer Linear Programming (MILP) approach. The proposed method takes into account the network traffic specifications as a whole, to reduce the packet collision and improve the DER rate which results in improved QoS. The authors in [48], presented the Channel Coding Adaptive Redundancy Rate protocol (CCARR), which introduces Forward Error Correction (FEC) frames to increase the Packet Delivery Rate (PDR) in LoRaWAN networks. As soon as enough frames are received, the method enables the reconstruction of lost frames to improve the throughput. The whole transmission Time on Air (ToA) is controlled by a completion acknowledgment, which reduces unnecessary redundancy and improves QoS. The Marcum function is presented to estimate the performance of LoRa in terms of Bit Error Rate (BER) in a timely and precise manner to improve the QoS [49]. The authors in [50], present a unique multi-hop data routing mechanism for IoT applications over LPWAN. The technology uses Quality-learning (Q-learning) to increase network performance in the context of QoS

TABLE 2. Impact of design objectives on LPWAN goals and leading techniques [17].

	Power Consumption	Coverage	Cost	Structural Scalability	Load Scalability	Interference Management	Integration	Quality of Service
Licensed or Unlicensed Spectrum	None	High Licensed Spectrum	High Unlicensed Spectrum	None	High Licensed Spectrum	High Licensed Spectrum	Moderate Licensed Spectrum	Moderate Licensed Spectrum
Frequency Range	None	Moderate Narrow-band	Low Narrow-band	Moderate Narrow-band, Wide-band (Spread Spectrum)	High (for Unlicensed Spectrum) Depends on local regulations	High Narrow-band, Wide-band (Spread Spectrum)	High Narrow-band	Moderate Narrow-band, Wide-band
Carrier Frequency	None	High Lower Frequency	None	None	High (for Unlicensed Spectrum) Licensed Spectrum	None	None	Moderate Sub-GHz band
Modulation Technique	Moderate Binary Schemes (Small Packets), M-ary FSK (Large packets)	Low (For Licensed Spectrum), High (For Unlicensed Spectrum) UNB, Spread Spectrum	Low Binary schemes	Moderate UNB, QPSK	High (for Unlicensed Spectrum) Spread Spectrum, Hybrid DS-SS / LoRa	High FHSS, UNB, LoRa	High UNB	Moderate UNB and Spread Spectrum
Channel Access Method	Moderate ALOHA	Low Spread Spectrum	Moderate ALOHA	High OFDMA, DS-SS (CDMA)	High (for Unlicensed Spectrum) LBT/AFA, FH-SS	High OFDMA, FHSS, CSS	Moderate Spread Spectrum	Moderate Channel Coding Techniques
Duplexity	High No Duplexity Scheme	None	High No Duplexity Scheme	Low No Duplexity Scheme	Moderate No Duplexity Scheme	Low Full Duplexity	Low No Duplexity Scheme	Moderate Full Duplexity
Signal Diversity Technique	High No Diversity Scheme	Moderate Space, Time, Frequency	High No Diversity Scheme	Low No Diversity Scheme	Low No Diversity Scheme	Moderate Space, Time	Moderate Space, Time	Moderate Space, Time
Business Model	Low Subscriber-Driven	Moderate Manufacture-Driven	High Subscriber-Driven	Moderate Manufacture-Driven	None	None	High Subscriber-Driven	None

As shown in the above table we offer a summary of each design decision made in relation to a number of approaches used in LPWANs and their capacity to achieve design objectives. Each cell contains the impact, which is followed by leading methodology in the next line.

and energy efficiency. Data transmission delay, throughput, bandwidth usage, and data interference are the different factors considered while determining the QoS.

Each LPWAN technology strives to meet the aforementioned design objectives by employing a variety of decision-making processes, each with its own set of benefits and drawbacks. As is often observed a trade-off, such as exchanging bandwidth for data rate or vice versa is

required for optimal network performance [17]. When building a wireless network, several selections must be made, including frequency spectrum, carrier frequency, frequency range, channel access method, modulation technique, signal diversity techniques, mode of duplexity, and business model. The impact of the different design parameters on achieving the LPWAN goals in Table 2 can be interpreted as follows.

High: Changing this parameter will always have a major impact on meeting the objectives.

Moderate: Changing this option will always have a moderate influence on accomplishing the objective.

Low: Adjusting this decision always has a minor impact on achieving the design goals.

None: Changing this decision has no impact on achieving the desired objective.

III. LPWAN TOPOLOGIES, ARCHITECTURES, AND INTEROPERABILITY

After taking a detailed look at the design objectives and the different strategies adopted to achieve them in the previous section, we explore different topologies, architectures, and their interoperability suited for the implementation of LPWANs in the current section.

A. TOPOLOGIES

Star and mesh are the two prominent topologies that are preferred in the majority of network implementations. In the case of LPWAN, star or star-on-star topologies are chosen over mesh networks to conserve battery life and increase communication range. As LPWANs provide long-range connectivity, single-hop networks can connect to a large number of nodes, reducing the cost of implementation. We elaborate further on the two prominent topologies in the rest of the subsection.

Star topology is a basic point-to-point (P2P) network structure where the peripheral nodes connect to a central node known as the gateway or hub as shown in Fig. 5. The gateway is the only means for the peripheral nodes to talk to each other. The connection between the gateway and the end devices forms a configuration that emulates a star and hence the name of the topology. The messages from the peripheral nodes are routed through the gateway to the network server, where they are checked for redundancy, faults, and security. It is common in remote monitoring applications, and it is especially beneficial in hazardous areas where running wires is difficult or risky.

In certain complicated configurations, the data from an end node can reach more than one gateway. In such a scenario, the requirement of gateway-to-gateway communication is eliminated and is more suited to applications supporting mobile end nodes. Due to its single-hop nature, star networks are fast and dependable. In addition, the star topology limits the impact of a failure of an end node. Faulty nodes can be easily detected and isolated without affecting the rest of the network. It also facilitates the addition or removal of new nodes without affecting the performance of the network. The topology however runs the risk of a single-point failure of the central hub. In other words, if the gateway goes down, all the end devices associated with it are not reachable.

A mesh topology in contrast consists of sensor nodes, gateways, sensor-cum-routing nodes connected as shown in Fig. 6. In a full mesh topology, all nodes can link directly to one another. On the other hand in a partial mesh topology,

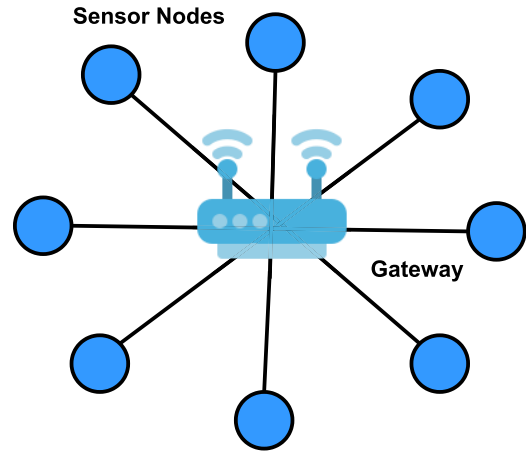

FIGURE 5. Star topology.

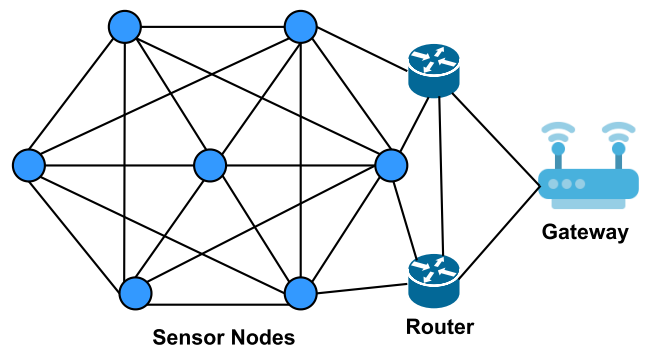

FIGURE 6. Mesh topology.

some of the nodes are fully connected while others are only connected to the nodes with which frequent messages are exchanged. Mesh networks have several advantages such as providing alternate routes for data transmission, addressing the problem of single-point failure observed in a star topology, supporting an exchange of data in Full-Duplex (FD) mode, improving network scalability, and aiding in self-healing of the network. However, mesh topology is not without its fair share of drawbacks which include an increase in complexity due to the presence of multiple links between two specific nodes, an increase in latency due to multi-hop communication, and an increase in implementation cost. In addition, the network's energy efficiency is also reduced due to node redundancy.

Tables 4 and 5 in Section IV present a tabulated comparison of the topologies used by different LPWAN technologies. The major architectures in different LPWAN technologies and their interoperability are elaborated next.

B. ARCHITECTURES

The basic LPWAN architecture essentially consists of end devices, gateways, network, and application server, as shown in Fig. 7. In addition, wired as well as wireless access between components, connection to the internet, and cloud for data

backup and processing also form a critical link in the network architecture.

The primary job of the end nodes in the architecture is to gather relevant information based on the application. In addition, the information can be passed to the next higher layers in the architecture for further processing or respond suitably as per the input depending on the implementation. The collected data is commonly transferred to the wireless access station through a dedicated radio channel and thereafter to the backend of the IoT network. The radio link for device administration and device traffic exchange is provided by the access station. It ensures the radio links integrity based on acceptable BER, security, and QoS among other things. The base station communicates with the gateway/concentrator, which is also known as the core in some cases.

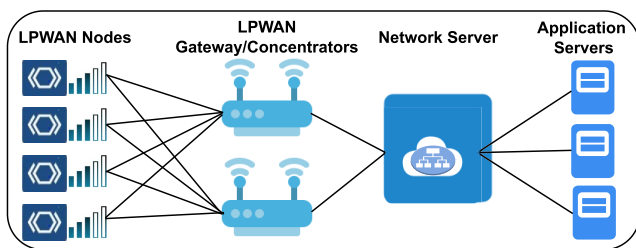

FIGURE 7. LPWAN typical entities [15].

The core is in charge of controlling and routing user traffic. It serves as a link between the access station and the IoT network, as well as a translator between protocols used by the access station and protocols supported by the network. Depending on the technology, a concentrator could offer edge computing and data storage to unload the cloud. Due to its proximity to end devices, it is especially useful in situations when the application requires real-time, low latency assistance. If applicable, the core may also provide priority treatment, robust admission, and mobility assistance for some specific LPWAN technologies. On the other hand, provisioning, registering, and operating LPWAN entities are all handled by the LPWAN server. It may also share or augment essential functionalities of the core such as traffic routing, security, and priority handling. The application servers and the cloud assist the LPWAN in managing a database that stores messages received from all of the linked items. It might analyze and act on the data using big data analysis.

Direct device connectivity to the gateway associated with LPWAN technology is provided by the fundamental architecture. In certain implementations, a mixture of different architectures is used. In this subsection, we explore two of the most well-known hybrid architectures. Fig. 8 depicts an architecture, in which several access technologies such as ZigBee, Wireless-Fidelity (Wi-Fi), and others provide primary connectivity to a device using their inherent architecture. The gateway of the preliminary network then gets

interfaced to the access point of the LPWAN giving rise to a mixed architectural setup. This is especially true for cellular type LPWANs.

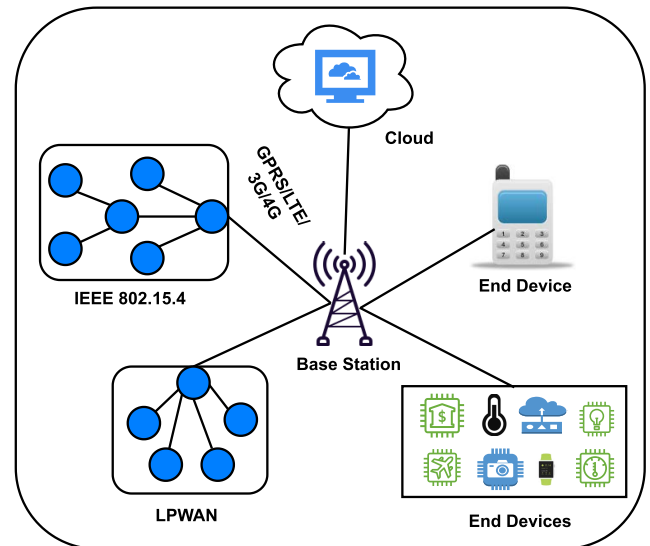

FIGURE 8. Generalized cellular type architecture [15].

Another hybrid architecture that makes use of numerous LPWANs to provide connectivity to a variety of end-device nodes [51], is shown in Fig. 9. It exhibits a scenario, in which devices have access to both SigFox and LoRa networks. Complex applications requiring diverse LPWAN technologies can benefit from such multi-technology resident hybrid networks. The data is collected by each LPWAN from the devices and nodes in their coverage zones. According to their coverage area, the corresponding base stations are installed. The user traffic data can be transmitted to the core network and the cloud via the LPWAN gateway or nodes. In a mixed architecture, the associated core network or network server entities provide device management activities such as authentication, registration, resource allocation, and data traffic control.

New techniques and architectures for creating cognitive LPWAN solutions based on AI & ML are also being investigated [33]. To support sophisticated communication, handle diverse IoT applications, and enable software-defined networking, these systems demand powerful cognitive computing capabilities. Cognitive LPWANs enable the coexistence and interoperability of a variety of LPWAN technologies, resulting in more efficient and convenient intelligent services for consumers. Green IoT, smart cities, and AI-enabled applications like health monitoring, smart homes, automated driving, and emotion detection are just some of the opportunities with cognitive LPWANs.

C. INTEROPERABILITY BETWEEN LPWAN TECHNOLOGIES

Many LPWAN technologies exist, each with its own set of defining features. These technologies’ usage provides diversity in operating frequency, modulation techniques,

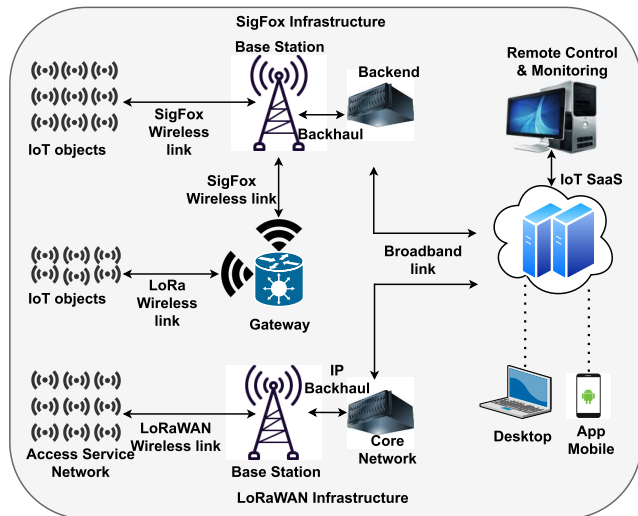

FIGURE 9. Mixed IoT architecture [51].

payload sizes and formats, mode of communication, network topology, MAC protocols, and FEC and security mechanisms. The long-term viability of these heterogeneous technologies depends on interoperability. These technologies must be well understood and compatible with one another to enable interoperability. To bring these technologies closer together, a great deal of effort is now being made by the 3GPP, Institute of Electrical and Electronics Engineers (IEEE), European Telecommunication Standard Institute (ETSI), and Internet Engineering Task Force (IETF). On the other hand, the authors in [9], suggested that the interoperability between LPWAN technologies can be facilitated by gateways, back-end base stations, IoT middle-ware, and virtualization.

The physical layer of the majority of LPWAN technologies uses Spread Spectrum (SS) and Ultra Narrow Band (UNB), modulation in addition to the more traditional modulation schemes and such diverse techniques make interoperability a challenge. The primary issues that arise from the coexistence of any two networks are mutual interference and blockage of uplink in both channels [52]. The coexistence of two networks in UNB-based LPWAN results in interference but the introduction of additional channels to both systems can minimize it. However, care must be taken to ensure that base stations can handle additional channels without hurting the system performance. On the other hand, interference management in SS-based LPWAN is more difficult compared to those using UNB-based techniques hence they are referred to as terrible neighbors, and reducing the impact of interference is a challenge. Various strategies suggested by the researchers for enabling interoperability among LPWAN systems are elaborated further.

The authors in [53], investigated the interference between NB-IoT and LTE signals and suggested a new channel optimization technique to reduce the sampling rate mismatch between the NB-IoT user and the LTE base station. Machine learning approaches, such as the block

sparse Bayesian learning-based technique [54], and the sparse machine learning-based approach [55], have also been explored to facilitate the coexistence of NB-IoT and LTE. On the other hand, the authors in [56], presented the results of a measurement-based coexistence analysis of LoRa and SigFox systems in the 868-868.8 MHz ISM bands. In different outdoor contexts (e.g., industrial areas, hospital complexes), interference influenced the coverage and capacity of LPWANs. The results demonstrated that both LoRa and SigFox technologies are very resistant to interference at various link budgets and ToA values. However, the power level of interfered and interfering signals, as well as the number of IoT devices deployed, have a direct impact on their performance. The authors in [57], performed simulation-based assessments of LoRa and SigFox network coexistence scenarios utilizing Chirp Spread Spectrum (CSS) and UNB methodologies. The results showed that as the distance between the base station and the interfering LoRa devices increased, their performance declined. The authors in [58], investigated interference that arises when different sub-GHz technologies (LoRa, SigFox, and Z-Wave) coexist. A controllable measuring setup with a micro-controller, an attenuator, a combiner, and a PC was created. It was observed that interfering signals from different sub-GHz systems affect the LoRa packets differently and a LoRa signal with a greater SF value had stronger resilience to interference. In [59], the 868 MHz ISM band was used to explore interference issues between LoRa and IEEE 802.15.4g. In an anechoic chamber, a series of experiments were carried out, and the results showed that LoRa packets were significantly more resistant to interference than IEEE 802.15.4g packets. It was further observed that based on signal-to-interfering power levels and LoRa bandwidth values, an SF of greater than 9 produces the lowest packet loss.

IV. LPWAN WIRELESS TECHNOLOGIES

In this section, we explore different LPWAN wireless technologies, which are separated into two groups based on the frequency bands they use:

- licensed (cellular) frequency band, and
- unlicensed frequency band.

Only authorized devices will be able to effectively utilize licensed band frequencies since services in these bands are provided only with a suitable subscription fee. In addition, these frequencies are extremely congested due to an increase in the number of cellular devices, particularly in densely populated urban areas. On the other hand, communication in unlicensed ISM band frequencies is available without any subscription fees but suffers from interference between devices using different protocols. The expansion of a network is simple and just involves the addition of new unlicensed base stations, while it is also possible to create private networks using peer-to-peer communication among the devices. The motivation to create a proprietary network is due to the following two primary reasons:

- the monitoring region is not covered by any other technology and
- control over infrastructure management [60].

For LPWAN devices, managing the energy consumption is a key factor because these devices are expected to operate autonomously for a longer period usually, for several years without any intervention [17]. It is often challenging to recharge or replace batteries, particularly, when a huge number of devices are deployed in far-flung or remote places with accessibility constraints. To further ensure that the devices are secure, regular firmware updates have to be provided. In the absence of easy physical access, it should be possible to provide remote firmware updates known as Firmware over the Air (FotA) [61]. Hence, the provision of FotA will become a key factor as well in choosing long-range technology.

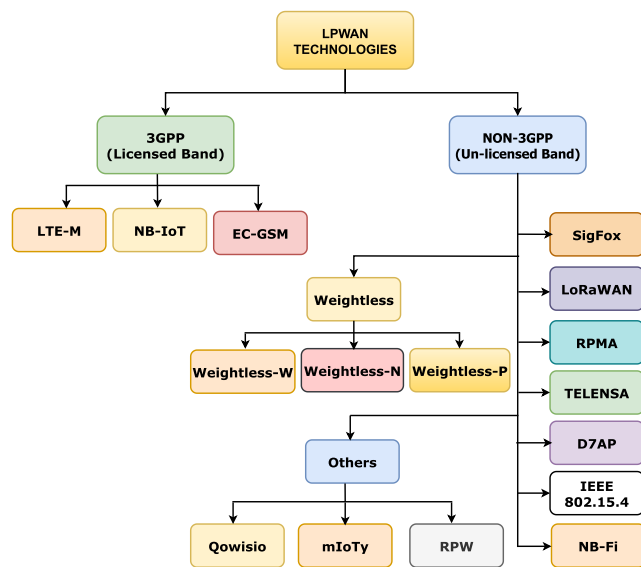

FIGURE 10. LPWAN technologies classification.

In the following subsections, we elaborate on the various unlicensed and licensed LPWAN technologies as shown in Fig. 10. A few of the discussed technologies are already deployed whereas the others are being currently tested. A comparison between the enlisted technologies is elaborated in the subsequent section.

A. LICENSED LPWAN TECHNOLOGIES

The most prominent and widely used wireless technology is the mobile-band (licensed) based cellular network. It has undergone several improvements over the years keeping in sync with the evolution of new technologies. The current standards for mobile technologies were proposed by the 3GPP consortium. The 3GPP consortium defines several standards to adapt to different IoT applications, mainly in the context of power consumption and energy restrictions.

The mobile technologies which are widely deployed for IoT applications and are currently in use can be listed as follows.

- Enhanced machine-type communication (eMTC a.k.a. LTE-M),
- Narrow Band IoT (NB-IoT), and
- Extended Coverage GSM IoT (EC-GSM-IoT).

A detailed description of the above technologies is provided in the subsequent subsections.

1) LONG TERM EVOLUTION FOR MACHINES (LTE-M)

Long Term Evolution (LTE) is a fourth-generation (4G) wireless standard that was introduced by the 3GPP consortium to provide higher network capacity and increased speed for cellular communication compared to the third-generation (3G) standards. LTE-M is also known as LTE Cat M1 or eMTC [12], is a variant of the LTE standard that has been specifically introduced to support IoT applications that require less battery power and wider coverage by reusing the already installed LTE base stations. eMTC supports a lower data rate of upto 1 Mbps (Megabits per second) using a bandwidth of 1.4 MHz as opposed to the 20 MHz required for basic LTE. It is possible to have FotA updates with eMTC. In general, eMTC supports FD communication but can also implement a Half-Duplex (HD) mode to enable a reduction in power consumption. Two additional features are introduced in eMTC for saving the power consumption [62], which are

- Power Saving Mode (PSM), and
- extended Discontinuous Reception (eDRX).

eMTC can also assist in handover between base stations, which is a crucial requirement for mobile IoT applications. In addition, LTE-M also supports Voice over LTE (VoLTE) services by using the licensed band of frequencies in the range of 700-900 MHz enabling a coverage and data rate of upto 11 km and 1 Mbps respectively. LTE-M uses 16-bit Quadrature Amplitude Modulation (QAM) technique which follows star topology and uses Frequency Division Multiple Access/Orthogonal FDMA (FDMA/OFDMA) as MAC protocol [63]. It uses a transmission power of 20 dBm with a battery life of 10 years. The link budget of LTE-M is 115.7 dB. An LTE-M-based network can provide connectivity to 80,000 base stations with security enabled and upto 1,000,000 base stations with security disabled. LTE-M has a latency of 150 ms for transmitting health data and consumes 8 μ A of current in sleep mode. Further technical specifications, power parameters, and performance metrics of LTE-M are summarized in Table-4.

The EXpanding LTE for Devices (EXALTED) architecture is used in LTE-M networks as shown in Fig. 11. It can be divided into two domains:

- the Network Domain (ND), and
- the M2M Device (the Gateway) Domain (DD).

The ND includes all components whose operation is linked to application control, security, and device management. The broad area access network in EXALTED is limited

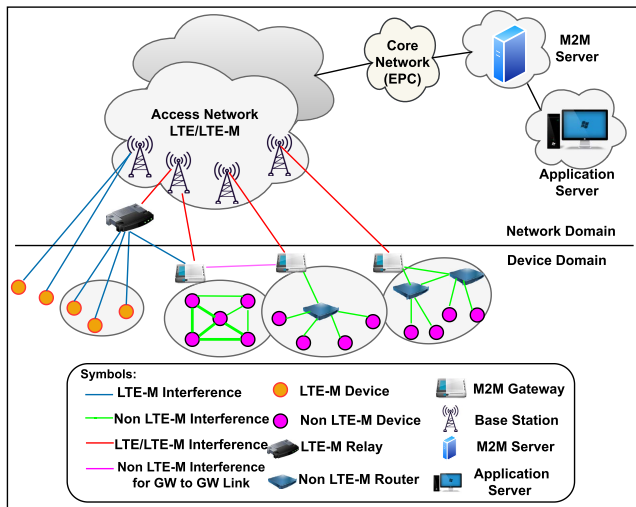

FIGURE 11. High level EXALTED architecture [64].

to the LTE-M/LTE technology. The ND also includes the Evolved Packet Core (EPC), which manages the cellular radio network, and the eNodeB (eNB), which is in charge of the Evolved Universal Terrestrial Radio Access Network (E-UTRAN). We presume that the application will execute on an EPC-enabled M2M server accessible over the internet [64]. The logical components, which are responsible for specific functions such as device and network component authorization and management, are also found in the network domain.

On the other hand, all devices that support one or more applications are included in the DD. The Uu interface or (Universal Mobile Telecommunication System (UMTS) interface between User Equipment (UE) and UMTS Terrestrial Radio Access Network) developed by 3GPP is the link between ND and DD. However, the air interface used in LTE-M is a self-contained radio access network that coexists with LTE in the same spectrum. The EXALTED architecture facilitates the communication between different kinds of devices in various use cases, where not all of them require the complete functionality of the network.

2) NARROW BAND-IOT (NB-IOT)

NB-IoT is a narrow band LPWAN technology that operates in the licensed band and can coexist with LTE or GSM bands. The NB-IoT protocol is built on the LTE paradigm where it will reuse the different building blocks and components of the physical and upper layers of the LTE protocol stack. In fact, NB-IoT will reduce the protocol stack functionalities of LTE to a minimum and modify them to fit the requirements of IoT applications. To cite an example, NB-IoT requires a bandwidth of 200 kHz which corresponds to one resource block of LTE and GSM bands of transmission [16].

The band of frequencies utilized by NB-IoT operates in the following modes as shown in Fig. 12.

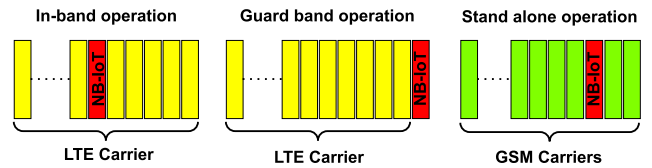

FIGURE 12. NB-IoT operational modes [16].

- Stand-alone operation: In this mode, NB-IoT uses currently existing GSM band frequencies.
- Guard band operation: In this case, it uses an unused resource block of the LTE carrier’s guard band.
- In-band operation: Here, it uses resource blocks of the LTE carrier.

As is evident from Fig. 12, the stand-alone mode utilizes GSM carriers while LTE carriers are utilized in the other two modes of operation. NB-IoT accommodates over 100 k devices per cell in general which can also be increased further by raising the number of NB-IoT carriers.

NB-IoT also operates in a licensed band of frequencies from 700-900 MHz just like LTE-M. It uses Quadrature Phase Shift Keying (QPSK) modulation technique, with a star topology [23]. It uses FDMA in uplink with a data rate and payload size per message of 158.5 kbps and 125 bytes respectively, whereas in downlink it uses OFDMA with a data rate of 106 kbps and a payload size per message of 85 bytes [16]. As per the authors in [65], NB-IoT uplink contains two channels, namely

- Narrow-band Physical Random Access Channel (NPRACH), and
- Narrow-band Physical Uplink Shared Channel (NPUSCH).

The downlink on the other hand contains 4 physical layer channels (data, control, broadcast, and synchronization channels). With an average transmission rate of 200 bytes per day, NB-IoT can last up to 10 years. It requires a transmission power of 20 dBm or 23 dBm and can cover a distance of up to 15 kms [22]. The NB-IoT link budget is 164 dB, and the health data latency is less than 10 seconds. The NB-IoT network has a per-cell capacity of more than 50,000 devices while it consumes a current of 3 μA in the sleep mode. The NB-IoT network is directly supported by cellular networks, facilitating the extension of NB-IoT coverage to all areas covered by the cellular network. As a result, NB-IoT has become the most dominant technology for the growth of IoT.

The NB-IoT architecture is depicted in Fig. 13, which is made up of five parts: the NB-IoT terminal, NB-IoT base station, NB-IoT core network, NB-IoT cloud platform, and vertical industry center [66].

3) EXTENDED COVERAGE GSM IOT (EC-GSM-IOT)

EC-GSM-IoT is another licensed LPWAN technology that was mentioned in 3GPP release 13. Unlike NB-IoT and LTE-M, EC-GSM-IoT is an eGPRS (Enhanced Data rates for GSM Evolution or Enhanced GPRS) based technology

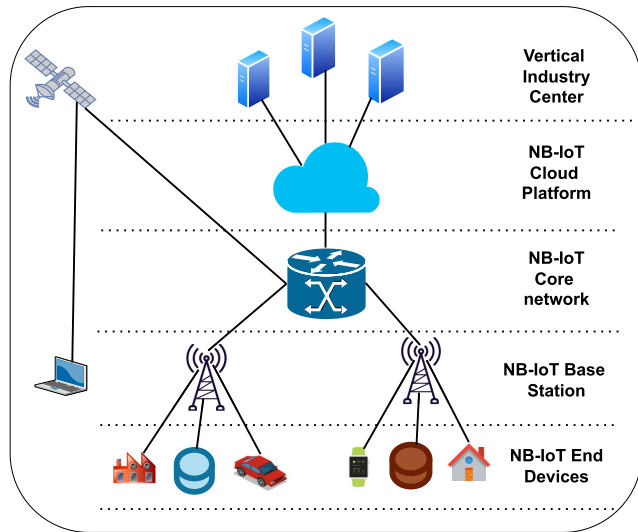

FIGURE 13. NB-IoT architecture [66].

commonly referred to as 2.75G. EC-GSM was created with the goal of providing long-range, high-capacity, low-energy, and low-complexity mobile systems for IoT applications [67]. Due to its power efficiency, the increased coverage of EC-GSM-IoT is regarded as equivalent to LTE-M in the GSM band. The data rate is expected to be either 70 kbps or 240 kbps depending on whether Gaussian Minimum Shift Keying (GMSK) or 8-PSK modulation techniques are used. EC-GSM-IoT allocates a bandwidth of 200 kHz per channel across the entire frequency span of 2.4 MHz [18].

The licensed spectrum of 800-900 MHz is used by EC-GSM-IoT, which uses Code Division Multiple Access (CDMA) as its MAC protocol and can support a maximum range of 15 kms when implemented using a star topology. This technology widely used in GSM-enabled IoT applications requires a transmission power of 23 or 33 dBm with a link budget of 164 dB [68]. The EC-GSM network has a per-cell capacity of 50,000 devices and consumes 10 μ A of current in sleep mode. Further technical specifications, power parameters, and performance metrics of EC-GSM are summarized in Table-4. The network architecture is comparable to the original GSM architecture as shown in Fig. 14, but requires new base-band software [69].

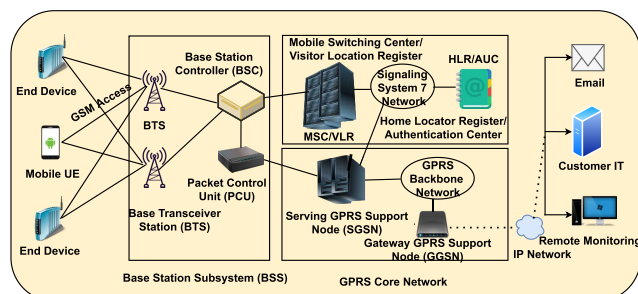

FIGURE 14. EC-GSM architecture [69].

B. UNLICENSED LPWAN TECHNOLOGIES

LPWAN technologies in the ISM band use an unlicensed spectrum for communication which does not require any form of authorization for usage in contrast to licensed LPWAN technologies. However, such usage has to respect the legal restrictions, e.g., the given duty cycle or maximum power transmission limits should not be exceeded. In the rest of the subsection, we will discuss in detail the following LPWAN technologies.

- SigFox,
- LoRa,
- Ingenu,
- Telensa,
- Weightless,
- DASH7,
- IEEE Standards, and
- NB-Fi.

1) SIGFOX

SigFox is an unlicensed, low-power, modest data rate, and inexpensive wireless network based on the ISM standard. It was developed by a French firm that began operations in 2009 with a vision of expanding its LPWAN services to more than 60 countries by 2018. The initial version of SigFox only supported communication from end nodes to the base station (uplink) using Differential Binary Phase Shift Keying (DBPSK). However, in the subsequent versions, downlink communication from the base station to end nodes was introduced by using Gaussian Frequency Shift Keying (GFSK). The maximum payload size per message is set to 12 bytes, and uplink transmission has a limit of 140 messages per day [30]. The downlink channel on the other hand allows only four messages, each with an eight-byte payload. As the message size is small, it takes less time to reach the gateway and uses a modest amount of power for data transmission and extending the network’s lifespan. In order to connect devices to the global network, SigFox uses its patented UNB-based radio technology which offers different benefits in the context of scalability, energy efficiency, network capacity, robustness, and signal coverage [21].

SigFox operates inside the unlicensed sub-GHz ISM band, with different frequencies used in various regions across the globe such as

- In Asia it uses 433 MHz,
- In Europe it uses 868 MHz, and
- In North America it uses 915 MHz.

It can support a bit rate of either 100 bps or 600 bps depending on the range of operation. D-BPSK modulation utilizes 1 Hz to transmit 1 bps, hence SigFox uses the 100 Hz frequency to broadcast 100 bps. D-BPSK has a low bit rate, which allows for additional demodulation time, a large link budget, and high receiver sensitivity at the base station [29]. The sensitivity of the base station varies depending on the data rate; for example, the receiver sensitivity for 100 bps is -142 dBm, whereas for 600 bps it is -134 dBm with

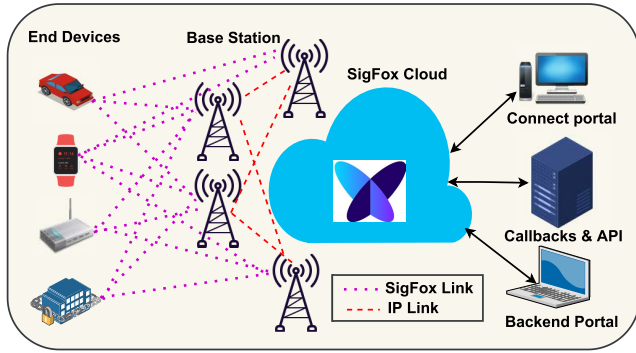

FIGURE 15. SigFox architecture [69].

a maximum coverage area of 10 km in urban areas and 50 km in rural areas [28]. The SigFox gateway can handle millions of devices connected in a star topology. SigFox is a single network that is available in multiple countries with no provision for inter-country connectivity. It requires 10-50 mA current along with 14 dBm power for transmission and 10 mA current for the reception. The link budget of a SigFox connection is 160 dB while the network has a per-cell capacity of 50,000 devices. It draws 6 nA current in sleep mode. The architecture of a SigFox network is as shown in Fig. 15.

2) LORAWAN

Semtech developed LoRa as one of the primary technologies in LPWAN, which enables long-range, low power, and reduced data rates. LoRa is a physical layer technology that uses the CSS modulation technique [70], and operates in different unlicensed ISM Sub-GHz bands of frequencies in various regions as follows.

- In India it uses 865 – 867 MHz,
- In Japan it uses 920 – 923 MHz,
- In China it uses 470 – 510 and 779 – 787 MHz,
- In the rest of Asia it uses 433 MHz,
- In Europe it uses 863 – 870 MHz, and
- In North America it uses 902 – 928 MHz.

CSS modulation supports FD communication with a high SNR and significant resilience to interference. The underlying protocols of LoRa are developed by a global alliance of influential telecom companies known as the LoRa alliance. The LoRaWAN is intended to provide secure, seamless wireless connectivity to battery-operated mobiles as well as static end nodes in different IoT applications.

The optimum selection of key parameters such as carrier frequency, bandwidth, spreading factor, and coding rate determine the transmission range, energy consumption, and resilience to the noise of an instance of a LoRa implementation [24]. In LoRaWAN, six different SFs (SF7-SF12) provide a trade-off between data rate and transmission range. As shown in Table 3, the greater the spreading factor larger the transmission range, and the lower the data rate [71]. Depending on the selection of spreading factor the data

TABLE 3. LoRa spreading factor for 125 kHz bandwidth [71].

Spreading Factor (SF)	Receiver Sensitivity (dBm)	ToA for 10 byte packet (ms)	SNR Limit (dB)	Bit rate (b/s)	Transmission Range (km)
7	-123	56	-7.5	5469	(0, 3.52)
8	-126	103	-10	3125	(3.52, 4.56)
9	-129	205	-12.5	1758	(4.56, 5.18)
10	-132	371	-15	977	(5.18, 6.28)
11	-134.5	741	-17.5	537	(6.28, 7.15)
12	-137	1483	-20	293	(7.15, 8.13)

rate of the LoRa varies from 0.3 kbps to 50 kbps with a maximum payload length of each message being 243 bytes, and the transmission range is 5 and 15 kms in urban and rural areas respectively [27]. LoRa can cover a range of up to 30 kilometers under water when operating at 868 MHz ISM band with 14 dBm transmission power [72]. It requires 28 mA of current for transmission and 10.5 mA for the reception while providing connectivity to 40, 000 devices per cell.

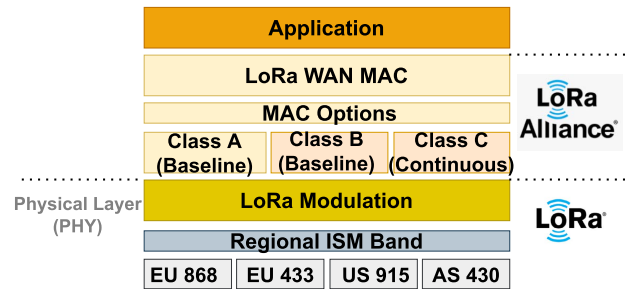

FIGURE 16. LoRaWANs physical and communication layers [19].

As illustrated in Fig. 16, LoRaWAN is composed of three kinds of devices: Class A, Class B, and Class C. These various classes of devices can be differentiated based on data latency and energy consumption. Class A devices consume less power but have to withstand longer delays. Class B devices require a moderate amount of power while the data latency is kept to the minimum. Class C devices on the other hand are always connected to external power sources and have a negligible amount of latency [19]. In most scientific studies, LoRa supports extended coverage when a decent LoS is possible, but gaining a better LoS in urban areas is a key challenge, resulting in a reduction in its operating range [28]. It is set up in a star topology and allows one end node to send messages to several gateways that communicate with the network server. A message issued by an end device can be received by multiple gateways as long as the gateways are within its transmission range. LoRa radio access technology is used to communicate between end devices and gateways. The gateways and the network server are interconnected via standard Internet Protocol (IP) connections as illustrated in Fig.17. The other technical details, power parameters, and performance metrics of LoRaWAN are shown in Table 4.

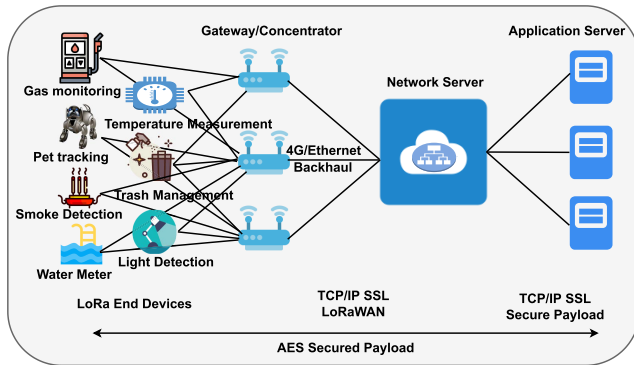

FIGURE 17. LoRaWAN architecture [19].

3) INGENU/RPMA

Random Phase Multiple Access (RPMA) is a proprietary technology of LPWAN, developed by Ingenu. In this technology instead of using the sub-GHz band as in LoRa and SigFox, Ingenu deploys RPMA to operate in the 2.4 GHz ISM band. As operation in the 2.4 GHz band is more flexible from the spectrum utilization point and does not suffer from strict duty cycle constraints as in the sub-GHz band so RPMA offers higher throughput and network capacity. But it is limited by increased propagation loss, compared to LoRa and SigFox [52].

RPMA is particularly designed to meet the design goals of M2M communication. The key strength of Ingenu RPMA is its immense large spectrum capacity (nearly 80 MHz) and ease of scalability. It supports bi-directional communication and offers an uplink data rate of 624 kbps and for downlink, it is 156 kbps with a payload size of 10 kB and health data latency of 10 seconds. RPMA provides coverage up to 10 km for rural regions and 3 km for urban areas with a decent LoS while maintaining a link budget of 168 dB and a receiver sensitivity of -142 dBm. The architectural view of RPMA with star topology is shown in Fig.18.

The modulation technique used by Ingenu is Direct Sequence Spread Spectrum (DSSS), whereas the MAC protocol is implemented using CDMA [9]. It has a maximum battery life of 10 years with a transmission power of 27 dBm. The RPMA network has a per-cell capacity of more than 50,000 devices. The 2.4 GHz band which was deemed advantageous for implementing Ingenu RPMA also turns out to be the reason for its disadvantage since this band of frequency is shared by other technologies such as Bluetooth, Wi-Fi, Zigbee, etc, thereby limiting the coverage of signal [15]. To improve the range of signals either the transmitted power from the end nodes has to be increased, making them less battery efficient, or more intermediate nodes have to be deployed increasing the average latency of the network as well as the cost (operation, deployment, and maintenance). RPMA is specifically built for automation in the oil and gas industry, as well as smart cities. [20].

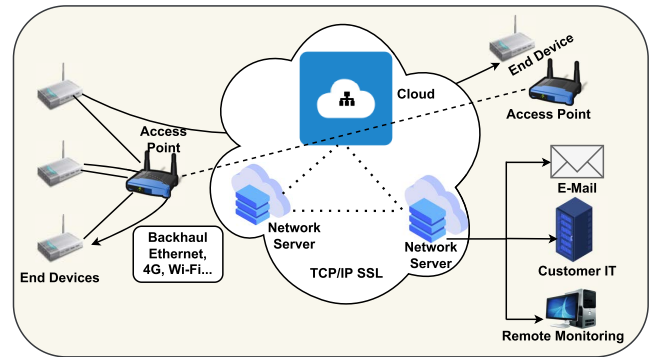

FIGURE 18. RPMA architecture [69].

4) TELENZA

It is a low-power, long-range LPWAN technology that employs a unique ultra-narrow band modulation approach to provide end-to-end services for IoT applications. Similar to LoRa and SigFox, Telensa offers bi-directional communication over unlicensed ISM sub-GHz bands of 868 MHz and 915 MHz. As it supports full-duplex communication it can be used for both monitoring and control of transmission [52]. The maximum data rate supported by Telensa for uplink is 62.5 bps and for downlink is 500 bps with a payload size of 64 kB. It can provide coverage upto 1 km in urban areas and 4 km in rural areas [15]. In Telensa, the devices are connected using a star topology where the base station can cater upto 5,000 low powered end devices. The end device has an approximate battery life of 8 years by maintaining a link budget of 160 dB and is preferably used in intelligent street lighting applications.

To ease the integration process in a heterogeneous setup, Telensa aims to standardize its technology based on the standards of ETSI for Low Throughput Networks (ETSI-LTN). At present, almost 30 countries are operating Telensa [20]. The other technical details about Telensa are summarized in Table 5.

5) WEIGHTLESS

Although LoRaWAN and SigFox cater to the needs of most IoT applications, it does not address the objective of all LPWAN applications. Weightless is an open-source LPWAN solution that can operate in both licensed and unlicensed sub-GHz bands [73]. It is based on the specifications defined by the Weightless Special Interest Group (Weightless-SIG) which are required to meet the needs of long-range LPWAN applications with a low transmission power of 17 dBm.

Based on technical capabilities Weightless technology is categorized into three different open standards:

- Weightless-W,
- Weightless-N, and
- Weightless-P.

Weightless-W: Weightless-W is the first standard of Weightless technology to operate exclusively in the TV-WS

frequency band of 470 to 790 MHz. In contrast to the other two standards, it offers outstanding signal propagation and long-range transmission. It employs a star topology and supports data rates from 1 kbps to 10 Mbps, with packet sizes of 10 bytes. It employs modulation techniques such as DBPSK and QAM [74]. In order to improve the energy efficiency in Weightless-W, the end nodes transmit data to the gateway using a narrow spectrum. As the TV-WS band is not widely accepted, the Weightless-SIG created two new standards- Weightless-N and Weightless-P.

Weightless-N: In terms of technology, Weightless-N is comparable to SigFox, which operates in the Sub-GHz band between 868 and 915 MHz. Neul, whose organization is named as NWave, is the major supporter of Weightless-N. It provides one-way communication from end nodes to base stations by using the UNB-DBPSK modulation technique and operates in a star topology. The maximum range supported by the standard is 5 km, with a bit rate ranging from 30 kbps to 100 kbps and a maximum payload length of 20 bytes per message. As a MAC protocol, it employs the slotted ALOHA technique [75]. It is an unsuccessful standard protocol whose responsibilities are given to ETSI. The failure is in terms of, an unbalanced link budget and usage of Temperature Compensated Crystal Oscillator (TCXO). Despite the failure of the standard, Weightless-N is preferred in London and Denmark.

Weightless-P: Weightless-P is perhaps the most recent standard developed by Weightless-SIG to overcome the shortcomings of Weightless-W and Weightless-N. It provides bi-directional communication with acknowledgments and operates in different ISM based Sub-GHz bands of frequencies (169, 433, 470, 780, 868, 915, and 923 MHz) [12]. Weightless-P is capable of operating in both licensed and unlicensed bands of frequencies offering a data rate between 200 bps to 100 kbps and can provide coverage upto a range of 2 km. It uses two different modulation techniques: GMSK and Offset-QPSK (O-QPSK) and employs TDMA/FDMA MAC protocols to ensure low energy consumption and better management of link quality [74], [75]. In contrast to other Weightless standards, Weightless-P exhibits short-range communication with less battery life. The other technical details are summarized in Table 5.

Weightless SIG divides Weightless-P's architecture into Base Stations (BSs) and End Devices (EDs). EDs are often simpler, less costly, and have a lower duty cycle than BSs. A cell in Weightless-P consists of multiple end devices connected to a single base station as shown in Fig. 19. To form a cell, all EDs communicate with a single BS, and BSs are connected via a network known as the Base Station Network (BSN). Resource allocation, scheduling, roaming, Adaptive Data Rate (ADR), and security are all managed by the BSN. The architecture of Weightless-P has a strong resemblance to LTE architecture, specifically the mobility feature which supports handover, roaming, and cell re-selection.

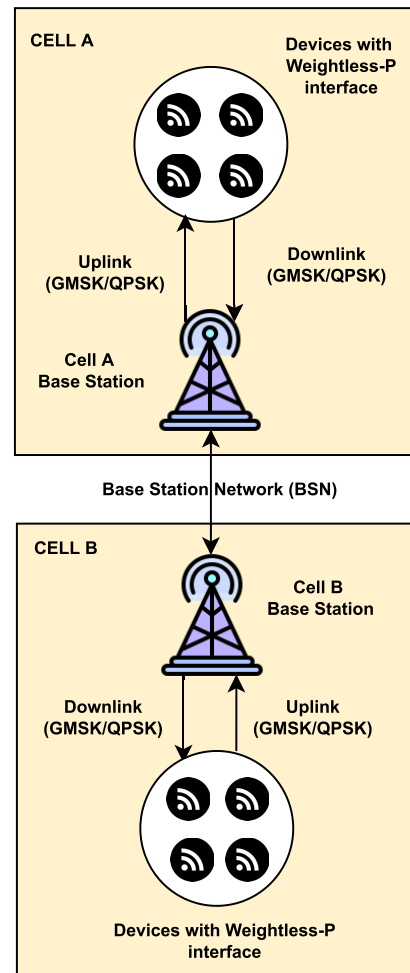

FIGURE 19. Weightless-P architecture [17].

6) DASH7

DASH7 Alliance Protocol (D7AP) is another name for DASH7, which is an open standard LPWAN technology specifically developed for ultra-low power, medium-range IoT networks. DASH7 uses a sub-GHz band of frequencies (433 MHz, 868 MHz, and 915 MHz) since it originates from ISO 18000-7, which specifies that active air interface communication should take place at 433 GHz by default, and active-RFID was identified and utilized by the Department of Defense (DoD). D7AP works on the principle of BLAST [76], which is elaborated as

- **Bursty:** specifies the format of data traffic used by D7AP,
- **Light:** refers to the maximum packet size of 256 bytes supported by D7AP,
- **Asynchronous:** alludes to the lack of synchronization in communication between elements of the network,
- **Stealth:** indicates D7AP allows only authenticated devices to communicate,
- **Transitional:** indicates D7AP supports mobility of devices.

D7AP employs the GFSK modulation technique and CSMA/CA as the MAC protocol. The data rates supported by

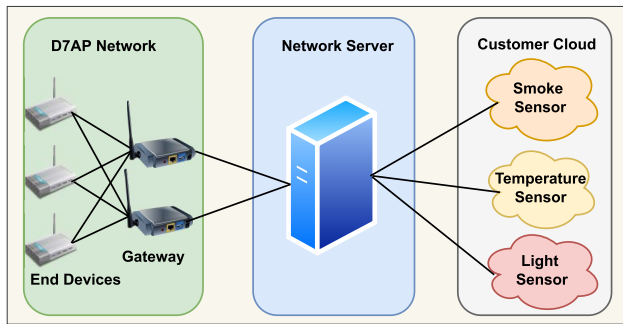

FIGURE 20. D7AP architecture [77].

it range from 9.6 kbps to 166.7 kbps with maximum coverage of 5 km. D7AP delivers low latency data transfer. The latency of data transfer in D7AP is low but comes at the expense of higher transmission power. The required transmission power in D7AP is 10 dBm at 433 MHz and 27 dBm at both 868 and 915 MHz, with a battery life of 10 years. D7AP's link budget is 140 dB [78]. The other technical specifications, power parameters, and performance metrics of D7AP are summarized in Table 4.

The D7AP Action Protocol (D7AActP), or D7AP Advertising Protocol (D7AAdvP), can be used to communicate between D7AP end devices and gateways or sub-controllers [20]. D7AAdvP is used for tag-talk-first uplink communications while D7AActP is used for downlink communications, both of which are meant to follow the BLAST principle and optimize energy efficiency. To provide reliable data transmission, DASH7 uses FEC and symmetric key cryptography. An architectural overview of D7AP is given in Fig. 20.

7) IEEE STANDARDS

Based on the specifications of 802.15.4 and 802.11, the IEEE has introduced three standard protocols for IoT:

- IEEE 802.15.4k,
- IEEE 802.15.4g, and
- IEEE 802.11ah.

IEEE 802.15.4k: A standard for Low Energy Critical Infrastructure Monitoring (LECIM) applications using both sub-GHz and 2.4 GHz ISM bands was developed by the IEEE 802.15.4k Task Group (TG4k). This was done in reaction to the failure of previous IEEE standards failing to work in long-range and high-density LPWAN applications. The IEEE 802.15.4k has two new physical layers which use DSSS and FSK modulation schemes. In IEEE 802.15.4k it is possible to employ multiple discrete channel bandwidths ranging from 100 kHz to 1 MHz. To meet the requirement of the new physical layers, the MAC layer supports CSMA, ALOHA with Priority Channel Access (PCA), and CSMA/CA without PCA. When end devices and ground stations access the medium, the PCA allows them to prioritize their traffic, which improves QoS. An LPWAN deployment for air quality monitoring based on IEEE 802.15.4k is elaborated in [79],

where a network consisting of 1 base station and 5 end nodes was deployed in the university campus within a 3 km radius using star topology. The deployment used a transmit power of 15 dBm and the 433 MHz band for communication. A sensitivity of -110 dBm, -123 dBm, and -129 dBm, was obtained at data speeds of 50 kbps, 1.2 kbps, and 300 bps respectively.

IEEE 802.15.4g: The first set of physical layer improvements proposed by IEEE 802.15 WPAN Task Group 4g (TG4g) was to improve the coverage of IEEE 802.15.4. This low data rate standard is primarily intended for use in applications like smart metering systems, which comprise a large number of fixed assets distributed across cities or nations. Three different modulation schemes - FSK, OFDMA, and O-QPSK are supported by the physical layer specified in the standard, to support data rates from 40 kbps to 1 Mbps.

The physical layer primarily works in the ISM (2.4 GHz and sub-GHz) band, with the exception of a single permitted band in the United States, and hence coexists alongside other interfering technologies in the same band while transmitting large data packets of size up to 1, 500 bytes.

IEEE 802.11ah: It is popularly known as Wi-Fi HaLow, and is mainly designed to provide better coverage compared to Wi-Fi while decreasing the power consumption by using the OFDM technique at the physical layer and offering a low data rate of 0.6 Mbps to 8 Mbps.

8) NB-FI

The NB-Fi alliance is a standardization body that collaborates with WAVIoT to develop a Narrow Band Fidelity standard (NB-Fi). WAVIoT collaborates with a variety of organizations to produce custom NB-Fi devices, with the NB-Fi alliance providing licenses for the custom devices. NB-Fi is a full-stack protocol that operates in the sub-GHz spectrum and employs DBPSK modulation at the physical layer [80]. The NB-Fi devices are connected to local base stations, which connect to cloud-based servers through Ethernet, Wi-Fi, GPRS, or Satellite. Surprisingly, NB-Fi base stations adopt a distinct method of edge computing for internal data processing. This allows NB-Fi to function even in the event of a power interruption. WAVIoT offers NB-Fi LPWAN in three different modes of networks [13], which are

- public networks: It supports coverage of an entire state or even a country,
- private networks: It provides coverage of an entire city, and
- enterprise networks: It can cater to only local areas.

The transmission power of NB-Fi is adjusted to either 14 dBm, 16 dBm, or 27 dBm. As the transmission power increases, its link budget also increases and so does the power consumption. It can support a maximum coverage of 16.6 km. NB-Fi requires a link budget of 174 dB when the transmission power is 30 dBm. The minimum data rate

TABLE 4. LPWAN specifications, power parameters and performance metrics [9], [11]–[13], [17], [20], [52].

Parameters	Technologies					
	LTE-M	NB-IoT	EC-GSM	SigFox	LoRaWAN	D7AP
Operating Frequencies	700–900 MHz	700–900 MHz	800–900 MHz	865 - 924 MHz	433, 868, 780, 915 MHz	433, 868, 915 MHz
Message bandwidth	1.08 MHz	180 kHz	200 kHz	100 Hz	7.8-500 kHz	18-21 kHz
Packet Size	2984-6968 bits	16-2536 bits	Unknown	12 Bytes	19-250 B	0-256 B
Duplexing Scheme	FD, HD FDD, TDD	HD, FDD	HD, FDD	Limited HD	HD, CSS	HD
Multiple Access Scheme	OFDMA	OFDMA	TDMA/FDMA	R-FDMA	Pure-ALOHA	CSMA-CA
Support for downlink Communication	Yes	Yes	Yes	Very limited	Yes	Yes
Uplink Modulation	BPSK, QPSK	BPSK, QPSK	GMSK	DBPSK	LoRa C-SS	2-GFSK
Downlink Modulation	BPSK, QPSK	QPSK	GMSK	GFSK	LoRa C-SS	2-GFSK
Encryption	3GPP 128-256 bit	3GPP 128-256 bit	3GPP 128-256 bit	Optional AES-128	AES-128	AES-128
FEC	Used for e-MBMS	YES	YES	NO	YES	YES
Uplink Sensitivity	-132 dBm	LTE Tower Sensitivity	GSM Tower Sensitivity	-142 dBm and -134 dBm	-137 dBm	-97 to -110 dBm
Downlink Sensitivity	-132 dBm	-141 dBm	-121 dBm	-130 dBm and 129 dBm	-137 dBm	-97 to -110 dBm
Transmission power	20 dBm	20-23 dBm	23 or 33 dBm	14 dBm and 27 dBm	14 dBm and 27 dBm	10 dBm and 27 dBm
TX power consumption	380 mA	74-220 mA	1228 mA	10-50 mA	28mA	29.2 mA
RX power consumption	53.33 mA	46 mA	66 mA	10 mA	10.5 mA	15 mA
Sleep mode power consumption	8 μ A	3 μ A	10 μ A	6 μ A	1 μ A	1 2 μ A
Reported Battery life	10 Years	10 Years	10-14 Years	10 Years	10 Years	10 Years
Uplink data rate	1 Mbps	106 kbps	0.35-70 kbps	100-600 bps	0.3-50 kbps	9.6 kbps
Downlink data rate	1 Mbps	79 kbps	0.35-70 kbps	600 bps	0.3-50 kbps	9.6 kbps
Base Station Capacity	80,000	52,547	50,000	Over 1,000,000	Over 1,000,000	Unlimited
Distance coverage (Rural)	11 km	100 km	15 km	50 km	18 km	1-2 km
Distance coverage (Urban)	<11 km	10-15 km	<15 km	10 km	5 km	1-2 km
Link Budget	155.7 dB	164 dB	164 dB	163.3 dB	155 dB	140 dB
Topology	Star	Star	Star	Star	Star and Mesh	Star, Tree
Network Deployment Cost	Low	Low	Low	High	High	Low
Mobility	Support	Not support	Support	Not support	Support	Support
Proprietary Aspects	Full stack	Full stack	Full stack	PHY and MAC layers	PHY layer	Open standard
Deployment model	Operator based	Operator based	Operator based	Operator based	Private and operator based	Private

of NB-Fi is 11 bps with uplink and downlink latency of 30 and 60 seconds respectively [81]. The other technical specifications, power parameters, and performance metrics of NB-Fi are summarized in Table 5.

C. NON-STANDARDIZED LPWAN TECHNOLOGIES

In contrast to the technologies described earlier in this section, the ones in this subsection are evolving and do not have complete specifications.

The field of LPWAN technology is constantly evolving due to its broad use in IoT applications. Mobility, scalability, high data rate, latency, and adaptability are all major challenges in LPWAN systems, especially in the unlicensed spectrum. As a result, there is a constant need to explore and review new implementations and standards to meet the evolving needs of different IoT applications.

Qowisio, Massive-IoT (MIoTy), and Rotating Polarization Waves (RPW) are a few recent technologies

TABLE 5. LPWAN specifications, power parameters and performance metrics [9], [11]–[13], [17], [20], [52].

Parameters	Technologies							
	NB-Fi	Ingenu	Telensa	IEEE 802.15.4k	IEEE 802.15.4g	Weightless-W	Weightless-N	Weightless-P
Operating Frequencies	433, 868.8, 915 MHz	2.4 GHz	868, 915, 430 MHz	Sub-GHz and 2.4 GHz	Sub-GHz and 2.4 GHz	TV white spaces 470 - 790 MHz	868, 915 MHz	169, 433, 470, 780, 868, 915, 923 MHz
Message bandwidth	50 - 25,600 Hz	1 MHz	100 kHz	100 kHz to 1 MHz	100 kHz to 1 MHz	6-8 MHz	200 Hz	12.5 kHz
Packet Size	8 B	10 kB	64 kB	2047 B	1500 B to 2047 B	>10 B	20 B	5-260 B (GMSK), 131-514 B (O-QPSK)
Duplexing Scheme	HD for end nodes, FD for base stations	Half duplex	Half duplex	Half duplex	Half duplex	Half duplex	Half duplex	Half duplex
Multiple Access Scheme	Unknown	CDMA	Unknown	ALOHA with PCA or CSMA/CA	CSMA/CA	FDMA/TDMA	Slotted ALOHA	FDMA/TDMA
Support for downlink Communication	Yes	Yes	Yes	Yes	Yes	Yes	No	Yes
Uplink Modulation	DBPSK	RPMA- DSSS	UNB 2-FSK	FSK, DSSS	MR-(FSK, OFDMA, O-QPSK)	QPSK, BPSK, DBPSK 16-QAM	UNB-DBPSK	O-QPSK, GMSK
Downlink Modulation	DBPSK	CDMA	UNB 2-FSK	FSK, DSSS	MR-(FSK, OFDMA, O-QPSK)	QPSK, BPSK, DBPSK 16-QAM	UNB-DBPSK	O-QPSK, GMSK
Encryption	AES-256 b	AES-256 b, 16 B hash	Yes	AES-128 b	AES-128 b	AES-128 b	AES-128 b	AES-128/256 b, AES-256 b
FEC	Unknown	Yes	Yes	Yes	Yes	Yes	No	Yes
Uplink Sensitivity	-148 dBm	142 dBm	-136 dBm	-129 dBm, -123 dBm, -110 dBm	-107 dBm	-128 dBm to -82.5 dBm	131 dBm at 0.625 kbps	131 dBm at 0.625 kbps
Downlink Sensitivity	-148 dBm	133 dBm	-130 dBm	-129 dBm, -123 dBm, -110 dBm	-104 dBm	-128 dBm to -82.5 dBm	-128 dBm to -82.5 dBm	120 dB at 6.25 kbps
Transmission Power	14 dBm, 16 dBm, 27 dBm.	36 dBm	23 or dBm	20 dBm	13-15 dBm	17 dBm	17 dBm	15-17 dBm
TX power Consumption	44 mA at 14 dBm, 90 mA at 16 dBm, 250 mA at 27 dBm	750mA	Unknown	5-25 mA	64.5 mA to 70.4 mA	Unknown	Unknown	49 mA
RX Power Consumption	12 mA	300mA	Unknown	Unknown	30.5 mA to 32.4 mA	Unknown	Unknown	13 mA
Sleep mode power Consumption	1.5µ A	0.072mA	Unknown	Unknown	Unknown	Unknown	Unknown	<4µ A
Reported Battery life	20 Years	10+ Years	8+ Years	10 Years	10 Years	10 Years	10 Years	3-8 Years (Coin-cell)
Uplink data rate	50 - 25,600 bits/sec	78 kbps	62.5 bps	1.5 bps to 128 kbps	4.8 kbps to 800 kbps	1 kbps to 10 Mbps	30 kbps to 100 kbps	0.625 to 100 kbps
Downlink data rate	50 - 25,600 bits/sec	19.5 kbps	500 bps	1.5 bps to 128 kbps	4.8 kbps to 800 kbps	1 kbps to 10 Mbps	30 kbps to 100 kbps	0.625 to 100 kbps
Base Station Capacity	2,000,000 nodes	52,547 nodes	5,000+ nodes	Over 1,000,000 nodes	Over 1,000,000 nodes	50,000+ nodes	50,000 nodes	32,767 n/w's, 65,535 Hubs each, 16 M edge devices per n/w.
Distance coverage (Rural)	30 km	Upto 48 km	5-8 km	Upto 20 km	10 km	>5 km	>3 km	25 km
Distance coverage (Urban)	10 km	15 km	2-3 km	5 km	below 10 km	5 km	3 km	2-5 km
Link Budget	174 dB	168 dB	Unknown	163.3 dB	155 dB	160 dB	147 dB	160 dB
Topology	Star, Mesh	Star, Tree	Star	Star	Star, Mesh	Star	Star	Star
Network Deployment Cost	Low	High	Medium	High	High	High	Low	Medium
Mobility	Support	Support	Support	Not support	Support	Support	Support	Limited support
Proprietary Aspects	Open Standard	Full Stack	Full Stack	Open Standard	Open Standard	Open Standard	Open Standard	Open Standard
Deployment model	Private	Private	Private	Private	Private	Private	Private	Private

introduced to meet the modified requirements while operating predominantly in the unlicensed sub-GHz spectrum.

1) QOWISIO
Qowisio represents a new generation of narrow-band operators who are transforming the IoT with an innovative

and disruptive concept. Qowisio is a multi-competency company that operates over the entire value chain of linked things, combining hardware, software, and telecommunications. As a result, Qowisio is positioned as a designer, operator, and integrator. Qowisio suggests a concept that is economically disruptive. It does not charge any additional fee across different specializations since all competencies are integrated. Connection is a commodity at Qowisio. As a result, Qowisio may provide end-to-end solutions without requiring a membership. Based on the deployment of its own bi-modal UNB/LoRa network, it proposes country-wide coverage [82]. The Qowisio LPWAN enables users to communicate small amounts of data multiple times each day at a reasonable cost. Qowisio consists of a full range of intelligent devices and is envisioned to be used with a plethora of applications like motion detection, energy and power monitoring, lighting, tracking, asset management, and several others [83]. The technical specifications of Qowisio however need further investigation.

2) MASSIVE IOT (MIOTY)

MIoTy is an LPWAN protocol aimed primarily for use in IIoT. Fraunhofer Institute for Integrated Circuits (F-IIC) invented MIoTy, which introduced a patented telegram splitting technology using the Frequency Hopping Telegram Splitting Multiple Access (FH-TSMA) concept, which has been standardized by the ETSI [84]. The FH-TSMA approach breaks the entire message into multiple sub-packets that are sent at different frequencies and times. This telegraph splitting method has the lowest packet error rate and can operate even in a crowded spectrum without interference. When compared to existing LPWAN technologies (LoRa, SigFox), the air time of the sub-packets is extremely long, decreasing the possibility of collision with other communications. As a result, MIoTy is well suited to underground or hard-to-reach applications where interference is a key concern [85].

MIoTy uses unlicensed sub-GHz frequencies of 915 MHz in the United States and in Europe it uses 868 MHz to enable a data rate of 512 bps. In the event of a line of sight communication, MIoTy can provide coverage upto 5 km in urban areas and 20 km in rural areas. It has an uplink budget of 153 dBm (14 dBm output power/-139 dBm sensitivity) and a downlink budget of 157 dBm (28 dBm output power/-129 dBm sensitivity), which is significantly better than LoRa, SigFox, and NB-IoT. It can transport a data payload of size 10 to 192 bytes and supports a relatively low data rate of only 2.4 kbps [86]. However, several research and experiments are still being conducted before the technology is standardized.

3) ROTATING POLARIZATION WAVE (RPW)

RPW was discovered in a Hitachi research center in Japan, and it is continuously being studied, implemented, and improved in research labs all over the world. It operates in the unlicensed sub-GHz band. RPW uses an innovative modulation technology called Rotating Polarisation BPSK

(RP-BPSK) to achieve its primary objective of improving the coverage area in non-line-of-sight (urban) environments [87]. It uses a maximum transmit power of 10 mW and a message bandwidth of 125 kHz. In [87], the simulation results in modulation of RPW show better performance even under multi-path fading and interference conditions compared to LoRa and SigFox. In addition, it gives better performance in irregular terrain with heavy foliage cover and mountains. However, standardization of RPW is a work in progress as aspects like latency, scalability, power consumption, and mobility are still being explored.

V. COMPARATIVE STUDY OF LPWAN TECHNOLOGIES TO MEET THE VARIOUS DESIGN OBJECTIVES

LPWAN is an umbrella word that encompasses a wide range of technologies, as discussed in Section IV. However, selecting the right technology satisfying the requirement of energy consumption, device lifetime, coverage, scalability, latency, deployment, payload size, cost, and QoS for a given application is a major challenge. In the following subsections, we explore the suitability of different technologies discussed in Section IV to the needs of various LPWAN design objectives.

A. ENERGY EFFICIENCY

In a majority of IoT applications, several components of the network are battery-operated, and hence more often than not energy efficiency becomes a crucial factor in the selection of a technology for its implementation. Table 4 and Table 5 show three prominent modes of operation that mostly account for the power consumed in an application

- Transmit mode,
- Receive mode, and
- Sleep mode.

The reported power parameters in Table 4 and Table 5, are defined as the mean of estimates provided by manufacturers or are based on actual research for a typical implementation. In reality, battery life varies depending on the type of battery and the location in which it is used. Some technologies have the provision to customize the power consumption in different modes depending on the needs of the users. An increase in transmission and reception power improves the coverage at the cost of draining the battery faster. This is an implementational trade-off in sync with the LPWAN demands as per 3GPP Release 14 and is supported by NB-IoT, EC-GSM, and NB-Fi.

It is a common observation that cellular technologies use more power than unlicensed ones. The power consumed by a transmitter (TX) varies significantly compared to that power consumed by a receiver (RX) for unlicensed technologies. The power consumed by a TX is lowest in SigFox, LoRaWAN, and D7AP followed by Weightless-P and NB-Fi [88]. In contrast, the power consumption of a TX dramatically increases for NB-IoT followed by LTE-M compared to unlicensed technologies. On the other hand,

the power consumed by an RX increases from NB-IoT to DASH7 by almost 300 %. The power consumption of an RX in licensed spectrum solutions is also drastically more compared to unlicensed solutions. The sleep-mode power consumption plays a very important part in IoT where most of the sensor devices operate in low power mode for a majority of the time. Although the difference between NB-IoT and unlicensed-spectrum technologies is minimal, cellular solutions are expected to consume more power than unlicensed-spectrum LPWANs. In contrast to other LPWAN technologies, SigFox consumes significantly less power in sleep mode operation. This, paired with its limited downlink capabilities, makes it ideal for uplink operation, transmitting data from the sensors and data recorders to the central hub.

A comparative study of the influence of various parameters on energy consumption is shown in Section II. The validation of one such conclusion in comparing the effect of MAC protocol on energy efficiency is evident from the fact that LoRaWAN and SigFox, using ALOHA multiple access method and a comparable Random FDMA (R-FDMA) respectively, use the least amount of power during message transmission. Table 2 in section II also concludes that modulation techniques using binary schemes have a better influence on energy efficiency - a fact that is corroborated by the energy efficiency of SigFox and NB-Fi which uses BPSK on the uplink channel. Similarly, the modulation used in LoRaWAN is often said to be energy-efficient, as evidenced by LoRaWANs low power usage.

B. COST OF IMPLEMENTATION AND OPERATION

Several variables such as regional costs, subscription fees, and inflation make it difficult to establish the precise cost for each LPWAN in general. However, by analyzing prior studies and comparing the pricing of devices and subscriptions as supplied by manufacturers, it is possible to provide a comparative cost estimate between different technologies. A general perception is subscription fees for Subscriber-Driven (SD) systems and recurring service charges will always be more compared to transceiver cost of Manufacturing-Driven (MD) systems since monthly payments quickly overwhelm upfront equipment expenditure. However, based on the organization's resources available and level of expertise, managing an MD network and its equipment can cost more than maintaining an SD network. In addition, the complexity and size of a network are also crucial parameters to determine which strategy is the most cost-effective. The prices mentioned in this section are in terms of US dollars.

The majority of the LPWANs addressed in this study are SD networks among which the cost for licensed networks increases due to license provider fees. The subscription costs for licensed technologies are given as \$5 for LTE-M in 2016 which was reduced to \$3.3 in 2020, NB-IoT on the other hand charged subscribers \$4 in 2016 which came down to \$2-3 in 2020, and for EC-GSM it was \$5.5 in 2016 and \$2.9 in

2020 [89]. Telcos charge customers based on the usage of data and bandwidth.

In the absence of subscription fees, comparing MD networks necessitates comparing the cost of individual devices. The only MD networks described are LoRaWAN, Weightless-P, and D7AP, which allow businesses to build their own infrastructure networks. A Weightless-P device can cost from \$1-5, as per the authors in [90]. According to the authors in [16], the cost of a LoRa device ranges from 3 to 5 euros (\$3.3-5.6) which makes both the technologies cost-equivalent from a device cost perspective. However, if the cost of establishing and sustaining a private or home network is more compared to the network's intended function then LoRaWAN is a more cost-effective approach since it supports interface with third-party networks which offer a variety of subscription options. D7AP gateways cost between \$100 to \$1,000 according to [77]. Due to a variety of reasons outlined in [77], D7AP end devices are costly to implement.

According to the NB-Fi Alliance, the cost of NB-Fi membership varies from \$4.10 to \$5.60 per device per year, depending on the number of devices [81]. Both discovery and enterprise subscriptions are available in SigFox deployed through its trusted providers. While the discovery pricing is dependent on individual devices, the annual subscription cost per device keeps varying depending on the region of implementation and the daily message limit. In the United States, this ranges from \$13.75 to \$33.00 as of August 2021. Based on this comparison, it is logical to conclude that SigFox and NB-Fi are cost-effective choices. Their subscription fees are quite modest and so is the cost of deploying and maintaining a small network. SigFox transceivers cost \$2-3 upfront, whereas NB-Fi transceivers cost \$4.99.

This discussion backs up the assertions made in Sections II to obtain minimal cost. The licensed band technologies are in general more costly compared to unlicensed technologies although other factors also influence the cost associated with a specific technology. The network deployment cost for all the LPWAN technologies is given in Table 4, and Table 5. In addition, Table 6, in Section V summarizes the performance comparison among all the LPWAN technologies with respect to their design objectives by highlighting the best leading performers and worst performers.

C. COVERAGE

The coverage of any LPWAN technology is determined by considering the range from its base station to which it can communicate as well as its ability to pass through barriers. To determine the effect of obstacles on transmission range, most technologies separately list rural and urban ranges, anticipating that rural areas are less congested and are affected only by the nature of the terrain, the presence of foliage, or both. Table 4 and 5 in Section IV summarizes the distance covered by different LPWAN technologies in both urban and rural areas. It can be observed as a general rule of

thumb that technologies supporting higher coverage in rural areas generally have a higher range in urban areas too.

In [91], the authors investigated the capacity of several LPWANs to penetrate obstacles in large rural areas. Rural indoor environments with a 20 dB penetration loss result in producing 1% outage for SigFox, LTE-M, and NB-IoT and a 2% outage for LoRaWAN. On the other hand, deep-indoor scenarios with a 30 dB penetration loss, results in an outage of 20% for LTE-M and LoRaWAN, 13% for SigFox, and 8% for NB-IoT.

Other researchers in [92], found that LoRaWAN works effectively in an indoor environment even for communication across an opaque wall. NB-Fi is found to have better obstacle penetration capability compared to LoRaWAN and SigFox. As per the authors in [77], D7AP has strong obstacle penetration power as well and can penetrate through walls, water, and concrete walls easily.

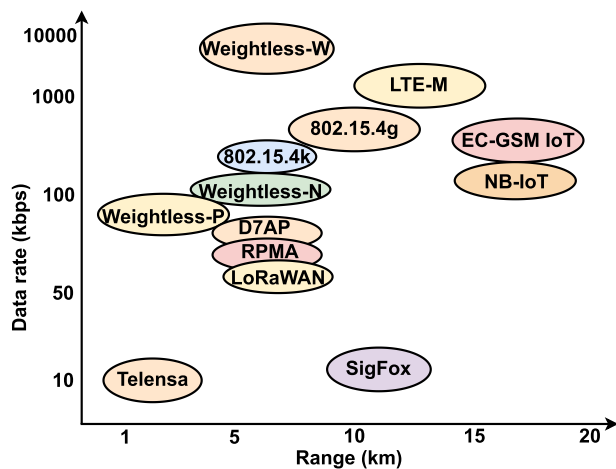

FIGURE 21. Comparison of various LPWAN technologies in terms of range and data rate [11].

As there are no regulatory limits restricting transmission power, licensed-spectrum solutions should theoretically give a larger range. However, there are certain LPWAN technologies in the unlicensed band as well that can support long-range data transmissions such as SigFox, and NB-Fi. NB-IoT is the clear winner, with a range of up to 100 km in rural regions with superior obstacle penetration. In terms of obstacle penetration, SigFox comes next supporting a communication range of up to 50 km in rural regions [91]. NB-Fi on the other hand can provide coverage of upto 30 km with good obstacle penetration. In contrast, both Weightless-P and D7AP have a very short range of operation. Fig. 21 shows a clear trade-off between the data rate and coverage of various LPWAN technologies. As a general observation, it can be stated that licensed technologies provide a higher data rate as compared to unlicensed ones with Weightless-W being an exception. Similarly licensed LPWAN schemes are usually found to have better coverage compared to unlicensed technologies. Among unlicensed technologies, SigFox has

the highest range whereas Telensa is quite ineffective in both data rate and coverage perspectives.

D. SCALABILITY

Quantitative assessments of the capacity of base stations are available for each LPWAN technology, making structural scalability reasonably easy to rate. With a base station capacity of more than 2,000,000 D7AP and Weightless-P are at the top of the list, followed by NB-Fi supporting up to 2,000,000 connections per base station [17]. On the other hand, the base station of LoRaWAN and SigFox can connect up to 1,000,000 possible devices. When security is enabled, LTE-M provides the highest structural scalability among technologies using licensed bands of spectrum, supporting up to 80,000 nodes. When security is disengaged, it can provide connectivity to 1,000,000 nodes which makes it comparable to solutions using an unlicensed spectrum. NB-IoT trails LTE-M in terms of scalability since it can provide connectivity to only 52,547 nodes while EC-GSM with connection to 50,000 nodes has the lowest structural scalability.

Since unlicensed solutions are subject to several constraints, their load scalability is determined by the legislation in place [77]. To cite an example, SigFox is constrained to send up to 6 messages per hour on the uplink and only 4 messages on the downlink per day. Similarly, LoRaWAN is restricted in ETSI zones due to the scarcity of Listen Before Talk/ Automatic Frequency Agility (LBT/AFA) mechanisms, while D7AP has restriction in Federal Communication Commission (FCC) zones due to the unavailability of spread spectrum modulation. Weightless-P, on the other hand, provides both SS modulation and LBT/AFA features, enabling it to have better scalability.

From the above discussion, unlicensed spectrum solutions have more structural scalability, while licensed spectrum solutions have more load scalability [52]. While building a network, a choice has to be made between load and structural scalability since none of the existing solutions provides both. We elaborate further on this as an open problem in Section VIII.

E. INTERFERENCE MANAGEMENT

In this subsection, we will discuss the management capabilities of relative interference for all the LPWAN technologies by using the analysis made in Section II E. While both licensed and unlicensed technologies are vulnerable to malicious jamming, unauthorized technologies also face the danger of accidental interference from other systems. However, UNB modulation considerably minimizes the possibility of accidental interference and malicious jamming. To cite some examples, NB-Fi uses UNB modulation with a bandwidth of 140 Hz to combat the ills of deliberate jamming. UNB modulation with a bandwidth of 100 Hz is also used in SigFox, along with the frequency-hopping technique which reduces the likelihood of hostile jamming. A combination of similar frequency hopping techniques and

FEC is used in Weightless-P to counter the interference effect. Thus we can infer, that UNB when utilized in conjunction with an FEC mechanism and spread-spectrum technique turns out to be fairly resistant to both deliberate and accidental interference. D7AP on the other hand uses FEC and 9-bit pseudo-random number generator (PN9) data whitening techniques to eliminate the threat of interference. It does not require the transmission of any beaconing signal to maintain synchronization since each end device keeps track of transmission precedence. However, in the unlicensed category, LoRaWAN using CSS modulation and its own LoRa protocol turns out to be most resilient to interference.

According to the authors in [19], NB-IoT in the licensed category has poor interference resistance as compared to SigFox and LoRaWAN. EC-GSM, another licensed technology that also operates in a narrow band of frequency like NB-IoT is even more susceptible to deliberate jamming compared to NB-IoT since it uses primitive channel access techniques such as FDMA/TDMA. In the licensed category, LTE-M is most resilient towards intentional interference, because it runs over a broader spectrum and uses a strong OFDMA channel access technique. The Cat. M2 standard proposed in 3GPP Release 14, is designed to transmit across a larger band, to further counter the interference effect.

F. QUALITY OF SERVICE

QoS is not related to a single parameter but is dependent on balancing several parameters such as throughput, latency, jitter, cost, and error rate as per the requirement of the application. When a trade-off between QoS and cost is considered, NB-IoT will be preferred for guaranteed QoS [52], [77]. In addition to NB-IoT, EC-GSM also provides better QoS as suggested in [89]. An integrated network of LTE-M and NB-IoT can provide better end-to-end QoS compared to other IoT networks. SigFox and LoRaWAN offer very poor QoS because they operate in the sub-GHz band with greater latency. Ingenu additionally employs the Viterbi algorithm for channel coding to ensure data delivery and to offer better QoS [93].

G. DISCUSSION

Table 6, summarizes the comparison among different LPWAN technologies in the context of their design objectives as pointed out in Section II. As mentioned earlier, various technologies achieve different design objectives by sacrificing some other goals. To cite some examples, LTE-M has a substantially higher data throughput than any other alternative, but it consumes more power. On the other hand, SigFox is the cheapest LPWAN, with outstanding communications range and obstacle penetration, but with the lowest data rate and load scalability. NB-Fi improves the metrics lacking in SigFox but at a higher cost and with a shorter range of communication.

Each application prioritizes LPWAN requirements differently, some applications might require a higher data rate

TABLE 6. Performance comparison between LPWAN technologies in terms of design objectives.

Design Objectives	Leading Performers	Worst Performers
Energy Efficiency	Unlicensed Spectrum Technologies	LTE-M, EC-GSM
Low Cost	Unlicensed Spectrum Technologies	Licensed Spectrum Technologies
Wide Coverage	NB-IoT, SigFox, NB-Fi	D7AP, Weightless-P
Structural Scalability	Unlicensed Spectrum Technologies	NB-IoT, EC-GSM
Load Scalability	Licensed Spectrum Technologies	LoRaWAN, SigFox
Interference Management	Licensed Spectrum Technologies	Unlicensed Spectrum Technologies
QoS	Licensed Spectrum Technologies	Unlicensed Spectrum Technologies

while others might look for wider coverage. As we further explore the boons and banes of different technologies, we will discuss in more detail the suitability of different LPWAN technologies to various applications in section VII.

VI. LPWAN MARKET OPPORTUNITIES

Since its inception, LPWAN technology has attracted a lot of interest from industrial consortia. The LoRa Alliance, SigFox, and Ingenu are among the technology companies that have released LPWAN devices. Another LPWAN vendor, Telensa has over nine million devices deployed across 30 countries. Their most effective use cases include smart lighting, parking, and tracking. In 2021, 25.1 billion IoT devices (mainly consumer applications) are predicted to be in use, with a possible expenditure of 3.9 trillion US dollars indicating a 32 percent Compound Annual Growth Rate (CAGR) from 2016. By 2023, NB-IoT is estimated to connect over 3 billion devices, accounting for a significant portion of this expansion. By 2024, IoT applications are estimated to generate \$4.3 trillion in revenue [94].

TABLE 7. By 2023, regional percentage share of mobile connections by network type [94], [95].

Region	3G and below	4G	5G	LPWAN
Global	29	46	10.6	14.4
Asia Pacific	22.6	52.5	12.9	12
Central and Eastern Europe	31.2	50.4	2.4	16
Latin America	36.8	50.3	7.3	5.6
Middle East and Africa	73.1	22.3	1.1	3.5
North America	0.8	45.2	17	37
Western Europe	13.4	43.1	15.8	27.7

By 2023, approximately 60% of mobile devices throughout the world will be 4G+ (4G and 5G) capable, outnumbering devices with 3G and below. In addition, it is proposed that by 2023, the Asia Pacific and North America will have the highest proportion of 4G+ devices and connections with a share of 65.4% and 62.2% respectively. North America, with

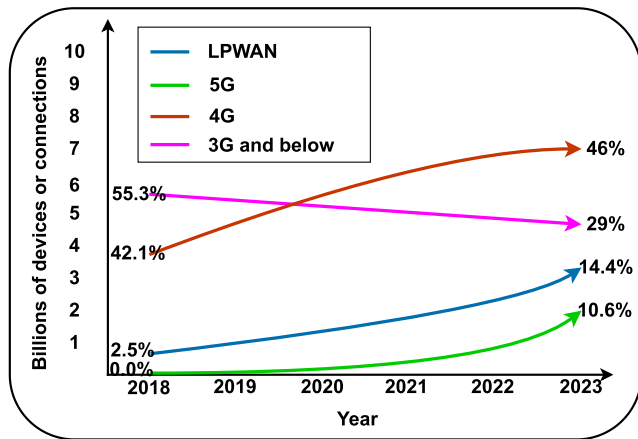

FIGURE 22. The change in percentage share and number of connected IoT devices across years using 2G, 3G, 4G, 5G, and LPWAN connections [94].

17% of 5G connections, will be the region with the largest share by 2023. On the other hand by 2023, 73.1% of devices and connections in the Middle East and Africa will be on 3G or low as shown in Table 7. North America will account for 37% of LPWAN adoption by 2023, while Western Europe will contribute 27.7% [95].

Fig. 22, shows a year-on-year change in the percentage share of the number of connected devices using LPWAN, 5G, 4G, 3G, and 2G technologies. The migration from 3G and lower to 4G and now 5G is a worldwide movement. The graph in the figure shows that the percentage share of total IoT devices connected via LPWAN is expected to increase from 2.5% in 2018 to 14.4% by 2023, accounting for an increase in the number of devices from 223 million to 1.9 billion [94]. This development implies that operators of mobile networks are looking for alternatives to cellular networks in order to provide M2M connectivity to their clients. Fig. 22, further illustrates the predicted expansion of 5G technology because of its larger data rate, in the M2M space.

VII. APPLICATIONS: WHICH TECHNOLOGY FITS BEST?

In this section, we investigate the suitability of LPWAN technologies for several use cases in diverse domains. For each use case, we assess the importance of the different design objectives as described in prior sections and suggest the suitability of LPWAN technology based on the requirements.

We also divide the applications into critical and non-critical categories. Breakdown of critical applications can pose a threat to the environment, can create financial instability, or can even lead to the loss of life. Critical systems, unless otherwise noted, require great reliability and real-time data rates. In this context, the authors in [11], consider the minimal value of data rate as 28.8 kbps for the baseline real-time communications. Furthermore, for any important system, LPWANs having low load scalability due to variables like duty cycle limits are absolutely undesirable. There will always be exceptions, but for the sake of convenience, we address only situations that are somewhat typical or

anticipated. In this section, we explore different applications and the suitability of appropriate LPWAN technology for them.

A. LOGISTICS

Supply Chain Management (SCM) is used to track goods and services at all stages of the supply chain. The authors in [96], explored that tracking is required at the package level, container level, and vehicle level. The SCM systems also change depending on what is being tracked. In [97], the authors suggest that goods in transition must be stored within a specific potential of Hydrogen (pH) range, temperature range, or not exposed to a specific vibration level. If this threshold is exceeded, it can cause damage, spoilage, or even death, as well as harmful reactions. To assure message delivery for crucial alerts with minimal latency, LPWAN technology must be used in logistics.

For pallet tracking, the authors in [14], suggested LoRaWAN because of its energy efficiency, low cost, and mobility support. On the other hand, SigFox is not preferred due to its limitations with mobile assets and unavailability in rural areas. In this context, DASH7 is suggested by the authors in [98], however, it supports only short-distance tracking. LTE-M, SigFox, NB-IoT, and LoRaWAN show the best localization accuracy out of which NB-IoT is superior [99]. LPWAN international roaming capabilities are also important for logistics firms that operate across national borders. SigFox automatically supports roaming using its monarch feature [100], while in LoRaWAN roaming features are supported since its revised version 1.1 (v1.1) [77], [101], [102].

As we consider the different perspectives and requirements, NB-IoT seems best suited for critical tracking systems like cold chains and has better accurate localization compared to LoRaWAN and LTE-M.

B. SMART BUILDINGS

The authors in [103], suggest a data custodianship paradigm for smart buildings, in which application scenarios are divided into two categories: safety/security and comfort. Under this approach, renters should have access to all the information through their own sensing devices, whereas building owners must have access to all the renters' safety/security information. The information linked to comfort sensing devices is only available to the renters who possess them. In the same research paper, an extra sensing category for tracking leaky pipes is provided; researchers suggest expanding it to make a third category for building integrity monitoring. The same custodianship requirements must apply to building integrity statistics as they do for safety/security information. We can easily recognize non-critical and critical use cases using the categorization in [103]. The use cases for safety and security are crucial, whereas the use cases for comfort are less so. Many building integrity applications are generally treated as non-critical since defects like leakages grow slowly and gradually.

However, detectors that identify serious and unexpected structural failure must be categorized as critical.

Most of the published studies on smart buildings have placed a premium on network capacity to penetrate internal barriers and communicate across walls, with LoRaWAN showing to be particularly effective. The authors in [92], suggested that LoRaWAN operating at 868 MHz exhibits better performance in terms of reliability and power consumption. On the other hand, the authors in [104], observed that the 434 MHz band showed better performance compared to 868 MHz. However, if the smart system is connecting multiple buildings over a large area, then SigFox and NB-IoT will exhibit better performance compared to LoRaWAN [91]. NB-IoT is suggested by the authors in [33], due to its features like high scalability, energy efficiency, low power consumption, better obstacle penetration, and wide coverage in the field of smart temperature monitoring and smart smoke detection. Authors in [14], while exploring the building integrity application proposed that lower deployment and operational cost and long-lasting batteries are more essential compared to frequent communications and their QoS. As a result, LoRaWAN and SigFox are both recommended. However, the authors in [11] suggested, every LPWAN system that can provide regular updates and alarms, is appropriate for smart building applications.

As a result of the foregoing discussion, we propose NB-IoT for intelligent building application scenarios including safety/security, because of its excellent load scalability, low network latency, and high dependability. Although NB-IoT can be employed for applications connecting several buildings, its low structural scalability may pose a challenge. LoRaWAN can be utilized in such scenarios because it offers good structural scalability, low power consumption, and a large data rate but its communication range is limited. D7AP is the best choice for both safety/security and comfort use cases if the connected buildings do not span more than 2 km due to its higher data rate compared to NB-IoT. Weightless-P is another alternative for real-time smart building applications, where the coverage area is small. For any video surveillance applications, LTE-M is suggested because of its high data rate [11].

C. SMART AGRICULTURE

Agriculture overlaps with some of the other domains discussed in this study. Agricultural applications include animal tracking, environmental monitoring, and infrastructure control. On the other hand, agriculture has its own set of standards and constraints that does not apply to other applications, irrespective of their similarities. Farm owners own the land and animals that are being tracked, which removes certain conservation constraints and allows for more actuation or intervention. This is supported by the authors in [105], where the claim is that farmers not only gather environmental information but also make adjustments to the environment when possible. A highly controlled greenhouse climate is one example of environmental adjustment and

suggests the D7AP protocol. Smart farming benefits from localization skills as well, especially when tracking moving cattle. The authors in [106], propose NB-Fi as the best viable solution for larger farms that demand more coverage because it provides great communication range, long battery life, and low cost. Though it does not support mobility, and its ability to localize is uncertain. If mobility is necessary, LoRaWAN can be deployed because of its low power consumption, less cost, and great structural scalability. In [107], the authors claim that LoRaWAN is able to gather real-time cattle data. NB-IoT can be used in applications requiring precise location and wider coverage. However, it is fairly expensive and is not suitable for remote locations where mobile connectivity is not available [108]. Farmers can also build more LoRaWAN repeaters or gateways on their own land without seeking any authorization. Sensors that measure temperature, humidity, and pH level can help in minimizing water consumption and increase production. As long as the surrounding conditions have not changed drastically, the devices update sensed data every hour or so. As a result, LTE-M, SigFox, and LoRa are excellent choices for this application [104].

D7AP or Weightless-P are also suitable for small-range agricultural production including animal growth facilities, greenhouses, and small animal enclosures, though their reduced localization precision should be addressed. Both the technologies provide fast data rates, mobility, and security. If physical compactness or longer battery life is important, then D7AP is a better option. Weightless-P on the other hand is a superior option if you need a range of more than 1-2 km.

D. MILITARY AND DEFENSE

Military groups must have sole custody of whatever network they use and should be able to install as well as disassemble quickly in any situation [109]. Military networks must be fast, dependable, and load scalable; yet, regulatory constraints might affect each of these needs. It will be beneficial if governments grant military communications an exemption from regulatory limitations when using these bands. D7AP, LoRaWAN, and Weightless-P are the LPWAN technologies that fulfill such specifications and are examined in this study.

Mobility is supported by all devices in a LoRaWAN setup demonstrating excellent doppler effect resistance [28]. LoRaWAN and Weightless-P boost stability and interference management through spread spectrum communications. However, on the other hand, D7AP aims for similar benefits with its BLAST design principle and extra usage of PN9 data whitening. Nevertheless, the bandwidth and spreading factor of LoRaWAN can also be modified, providing developers more control over the trade-offs in data rate, communication range, spreading factor, and bandwidth.

Defense systems present the risk of hostile forces using advanced military techniques such as jamming, interception, and direction-finding [110]. LPWANs must respond by offering end-to-end secure and encrypted services. The

authors in [109], demonstrated that even though LoRa packets could be intercepted, it is not possible to retrieve their encrypted content. However, the authors of the same paper inferred that further research needs to be conducted to improve the protocol's security from a military standpoint. Advanced Encryption Standard-128b (AES-128b) encryption is used by both LoRaWAN and D7AP, whereas Weightless-P can use either AES-256b or AES-128b [25]. Users can create their own higher-level protocols using D7AP, Weightless-P, and LoRaWAN because they are all open standards. It is possible to build closed systems for the military which meet their strict requirements. D7AP has also collaborated with the US DoD for acquiring military experience. If localization features or wider coverage are necessary, LoRaWAN can be employed, if the data transfer rate is crucial, D7AP and Weightless-P can be preferred [111]. Since D7AP has a smaller coverage compared to Weightless-P, it can be utilized when a long-range is not required. Because of its strong interference management and security, D7AP stands out as a good choice.

E. HEALTHCARE

The existing literature contains several use cases on IoT healthcare systems each having its own customized requirements. A wide spectrum of studies emphasizes the need for privacy and security. Stability, availability, extensibility, portability, and accessibility are some of the non-functional requirements listed in [112]. High-power radiation can potentially harm human tissue, according to the authors in [112], and any biomedical sensor should strive to reduce this risk. Healthcare can also benefit from localization skills, examples include monitoring and tracking vulnerable individuals during an emergency. According to the authors in [99], LPWANs could be a low-power substitute for GPS for patient monitoring.

The authors in [113], suggested that the LoRaWAN provides a smooth balance between security and affordability with improved system energy efficiency for health care applications. In addition, the authors suggested that such implementation is not suitable for uninterrupted real-time monitoring but can be used for sporadic reporting. The authors in [99], argued that LoRaWAN is inefficient for crucial alerts but excellent for tracking health indicators where its minimum power consumption, better scalability, extended coverage, and doppler effect resistance serves as advantages. On the other hand, the authors in [112], proposed NB-IoT for healthcare systems because of its energy efficiency, low power consumption, and low bandwidth requirement. As suggested by the authors, smart usage of higher layer protocols can serve well in using NB-IoT for real-time health monitoring applications. Authors in [77], suggested that D7AP can be used in healthcare systems but due to its narrow coverage D7AP is not suited to monitor patients over larger areas.

We recommend NB-IoT for healthcare applications and services whenever possible since it provides a high data

rate, is energy efficient, can cater to a wider area, is highly reliable, and has better load scalability. In addition, NB-IoT has superior localization features and does not cause harm to human tissue which makes it more appealing to healthcare applications. When NB-IoT is not available, LoRaWAN is a viable alternative with real-time communication speeds that have been recommended in prior research for healthcare applications with the limitations of the reduced area of service and restricted load scalability.

F. SUMMARY

According to our findings, relatively few use cases have a single notable LPWAN solution that is suitable for all scenarios. Instead, a variety of LPWANs can be used, and enterprises will choose the one that best fits their needs and requirements. In many instances, the geographical terrain and budget will have a significant impact on the decision. It is seen that, while a few LPWANs are used for specific purposes across multiple sectors, others have been better suited to a larger number of scenarios. To cite some examples NB-IoT is found to be extremely suitable for critical applications with a low margin of error while LTE-M is capable of supporting multimedia networking and broadband-like applications requiring a high transmission rate. Multicast communication is also possible with LTE-M, D7AP, and Weightless-P. In applications that require higher asset mobility, D7AP, LTE-M, Weightless-P, or LoRaWAN should be employed. The most accurate localization capabilities are provided by SigFox, LoRaWAN, LTE-M, and NB-IoT [111], where NB-IoT provides the best results as stated in [99].

For non-critical use cases, NB-IoT, NB-Fi, and LoRaWAN are generally recommended because they meet all LPWAN standards. When an application requires long-range transmission, reduced latency, or better load scalability, and can be supported by a larger investment then NB-IoT is the preferred choice. When high energy efficiency, medium bit rate, low investment, a limited radius of coverage, and reduced load scalability is the requirement, LoRaWAN is suggested. Furthermore, NB-Fi is suggested whenever a lower bit rate, with wider coverage, relatively low cost and energy efficiency are desired.

SigFox, EC-GSM, D7AP, and Weightless-P, are only suitable for a limited number of applications, but they excel on those. Weightless-P performs effectively in most LPWAN scenarios, however, its low range in densely populated regions is a drawback. On the other hand, its support for multicasting and mobility makes it a preferred option for networks with built-in open regions containing mobile assets. D7AP is analogous to Weightless-P, offering great performance with multiple features despite being restricted to a limited range. SigFox is a low-power, low-cost technology for up-link-only sensors which does not require great performance, such as data loggers or basic utility metering. EC-GSM can be used to deploy in locations where newer LTE networks are not available, as well as to integrate legacy GSM/GPRS networks.

TABLE 8. For various use cases, requirement analysis and the most suitable LPWANs [7], [11], [16], [17], [65], [77].

Use Cases	Requirements								Most Suitable LPWANs
	Energy Efficiency	Long Range	Scalability (SS = Structural Scalability) (LS = Load Scalability)	Low Cost	Robustness (Interference Management, Obstacle Penetration)	Up-link Performance	Down-link Performance	Mobility Required?	
Logistics (low risk)	High : Changing or recharging batteries is impractical because of the enormous number of potential devices, and items may be in transit or storage for extended periods.	High : Goods can be transported great distances from base stations and kept in basements, containers, or secure warehouses.	High (SS): The granularity of the system determines the exact structural scalability requirements, such as whether assets are recorded at the container, pallet, or individual item level. Low (LS): It isn't crucial than usual.	High : Higher-priced devices will be impractical to deploy because of the possibly enormous number of devices.	Low : It isn't any more crucial than usual.	Low : Large volumes of data are unlikely to be transferred, hence higher latency is acceptable.	None : Actuation is unlikely to be present in stock items.	Yes : While products are being transported, sensors must be able to communicate. Transporting goods over large distances and at high speeds is possible.	LoRaWAN, NB-IoT
Logistics (high risk)	High : Changing or recharging batteries is impractical because of the enormous number of potential devices, and items may be in transit or storage for extended periods.	High : Goods can be transported great distances from base stations and kept in basements, containers, or secure warehouses.	High (SS): Similar to standard logistics use case. High (LS): Sensor data and actuator orders for environmental control must be provided and received in real time.	Moderate : Companies will be willing to put more money into safety-critical sensors. However, the enormous number of sensors that may be used should be considered, as purchasing them would be impracticable due to the high cost.	Moderate : Critical system robustness should always be upgraded to provide better reception.	High : Alarms should be triggered when values exceed safe thresholds, and they should be delivered and received as soon as possible.	None : Actuation is unlikely to be present in stock items.	Yes : Regular communication will be more important for high-risk stock while in transit.	NB-IoT
Smart Buildings (Comfort, Building Integrity)	High : Tenants of buildings will be hesitant to use systems that considerably increase their electricity consumption.	Low/moderate : Low for tiny or standard-sized structures, and moderate for big complexes or networks with several features.	Moderate (SS): Highly integrated or massive facilities may necessitate a huge number of devices packed into a compact space. Low (LS): It isn't crucial than usual.	High : Tenants are unlikely to invest in excessively expensive devices and will normally want to keep costs to a minimum.	High : Communications must be able to penetrate signal-hostile materials like concrete, glass, and metal to cover the whole indoor and outdoor space of one or more buildings.	Low : It isn't crucial than usual.	Low : On an LPWAN scale, building integrity actuators are unlikely to exist, and comfort-related applications are optional.	No : Buildings and their sensors will almost certainly not move.	Weightless-P, D7AP (Higher performance), LoRaWAN (longer range).
Smart Buildings (Safety/ Security)	Moderate : While the same considerations apply as before, extra power consumption is frequently seen as a reasonable trade-off for increased safety.	Low/moderate : Low for tiny or standard-sized structures, and moderate for big complexes or networks with several features.	Moderate (SS): The use case for smart buildings is the same as usual. High (LS): To minimize possible loss and optimize human safety (such as activating sprinklers), equipment must be able to send an unlimited number of alarms (such as fire alarms) and receive actuation commands at any given time.	Moderate : While the same criteria apply as before, for key use cases, more spending is frequently appropriate. Furthermore, a landlord's responsibility for safety and security fittings is common.	High : Communications must be able to penetrate signal-hostile materials like concrete, glass, and metal to cover the whole indoor and outdoor space of one or more buildings.	High : Delays must be avoided at all costs. Surveillance applications will also need enough speed to send video, sound, or image data.	High : Again, any delay is unacceptably inconvenient. Many of the actuators for these use cases will be for fire sprinklers or security shutters, which can avert loss of life or harm.	No : Buildings and their sensors will almost certainly not move.	NB-IoT, LTE-M (Surveillance), D7AP (Short range).
Smart Agriculture	High : Long battery life has been emphasized by a number of sources. Crop monitoring devices may be required to function for the duration of the crop's growth cycle, which can be months or years.	Varies : Farms can be enormous, and they can be found in rural places far from base stations. However, some agricultural applications require tiny farms or enclosed areas like greenhouses and piggeries.	High (SS) : Agricultural IoT devices in the billions are expected to be used in the future to assist smart agriculture. Low/Moderate (LS): Usually low, however after extreme weather or farm accidents, measured values might suddenly alter.	High : Farm budgets are generally limited, and climatic situations such as drought can severely reduce them. Devices that are linked to animals or are placed remotely are likewise more likely to be broken, and a lower cost per device means a lesser net loss for the farm.	Varies : The geography of the land will determine how much water is available. Hilly, heavily vegetated, or interior habitats, as well as relatively open or flat locations, can be monitored. Because particular plants and animals thrive exclusively in specific sorts of terrain, this might build a connection with what is being cultivated.	Low/Moderate : Agricultural use scenarios rarely pose a threat to human life or cause considerable environmental harm. Failure to get information, on the other hand, can result in severe financial loss.	Low : When actuation components are used in farming, it is usually to avoid major resource waste or to control environmental variables for growth. A delay of a few seconds, on the other hand, is usually acceptable.	Varies : Livestock monitoring will necessitate mobility, but a tree or crop monitoring is doubtful.	LoRaWAN (mobility required), NB-Fi (No mobility required), D7AP, Weightless-P (short range, mobility required), NB-IoT.
Defense and Military	High : Many military devices will be stationed in isolated and potentially hostile locations. This makes battery replacement impractical frequently. Devices can also be used for long-term monitoring or intelligence collection, which requires a lot of power.	High : Devices could be deployed in remote locations or throughout huge, hazardous areas. The US Army's research emphasizes the importance of long-distance communications.	High (SS): The US Army stated at a strategic planning meeting that the Internet of Battle Items (IoBT) might be several orders of magnitude larger than any previous network, with up to a million things per square kilometer potential. High (LS): Military systems, like healthcare systems, are critical by nature because of the criticality of their data and the implications of late or undelivered data.	Low/Moderate : The US Army's IoT research stressed low cost as a design concept. Furthermore, compromised gadgets should be considered "disposable," which means that their loss is permissible. Devices need to be relatively inexpensive for this to be truly feasible. However, we've categorized this as "Moderate," because military budgets may allow for higher spending than usual.	High : Military networks will be required to not just operate in harsh and potentially blocked environments, but also to withstand aggressive attempts at jamming or other attacks by enemy forces.	High : Military command and control, as well as surveillance of armed forces, are both dependent on information. As soon as feasible, untampered intelligence should arrive.	High : Commands issued to personnel or military equipment should arrive as fast as feasible without being tampered with. The consequences of delaying military action could be disastrous.	Yes : Systems that track moving assets like guns, vehicles, and people should be able to move around. Because military assets move so quickly, very robust procedures will be required in these situations.	LoRaWAN (Localization required), Weightless-P, D7AP.
Healthcare	High : In several existing studies, long battery life is a priority. Patient independence and quality of life are hampered by the requirement to charge gadgets frequently. The risk of missing important events increases when devices are turned off.	High : Allowing gadgets to work across long distances and in different locations should increase user quality of life and freedom. Critical events may be missed if devices are out of range.	High (SS): Nursing homes and hospitals are examples of places where a big number of people can be crammed into a limited area. More people will be required to use healthcare gadgets as the human population expands and the average age increases. High (LS): By their very nature, healthcare systems are vital. Alarms should be received as soon as possible.	Moderate : In the healthcare industry, cost-cutting compromises are tolerable in exchange for consistency and speed.	High : Wearable sensors, in particular, should be able to tolerate the blockage of an attached human body. Healthcare systems must have powerful indoor communications capabilities and obstacle penetration.	High : Medical staff must get alarms indicating possible medical emergencies as quickly as possible. In medical situations, real-time communication is crucial since time is of the essence.	None : The majority of healthcare applications now being proposed involve passively monitoring patient health indicators. In the future, actuation may enable for remote medical assistance or resuscitation treatments; nevertheless, this is a complicated legal and ethical issue.	Yes : Medical devices and health care applications support mobility.	NB-IoT, LoRaWAN.

VIII. OPEN RESEARCH CHALLENGES AND FUTURE DIRECTIONS

System integration experts, network operators, and device manufacturers have focused their efforts on low-cost hardware design, reliable connection, and complete end-to-end application integration to achieve the different LPWAN design objectives. By reviewing the current status of LPWANs and their underlying difficulties, this section presents some potential research challenges.

A. SCALABILITY

To increase structural/horizontal scalability as discussed in Section II.D, more end-devices need to be connected to each access point, and more base stations are required to be deployed throughout the network [36], [37]. As a result of such expansion, LPWANs will be able to cater to applications, where structural scalability is currently limited.

For licensed-spectrum technologies, which are not subject to legal restrictions, improved load scalability can be obtained by using different design decisions of the network as discussed in Section II while in the case of unlicensed band technologies, which are subject to legal constraints such decisions are made to obtain the optimum performance within the regulations. For instance, implementing LBT/AFA in ETSI regions loosens duty cycling limitations. The fact that Weightless-P outperforms LoRaWAN in terms of load scalability is proven in Section V, while integrating LBT/AFA into LoRaWAN, could strengthen its position as per the authors in [114].

In addition to load scalability, vertical scalability also takes into account an individual sensor's processing capability and memory. This enables LPWAN technologies to achieve better performance in applications where LPWANs were previously overlooked because of unsatisfactory performance. Most of these applications fall under the category of edge computing, in which each node performs more processing than the centralized backend services. Edge computing minimizes the need for information transfer from the end devices and instead delivers the processing outcomes. Edge computing reduces the transmission of data, operational costs, and the use of backend infrastructure for processing.

Altering the design decisions of the existing technologies may provide more structural and load scalability but this will almost certainly come at the expense of other design objectives. For instance, the use of OFDMA technique will improve base station capacity, resulting in structural scalability. This, on the other hand, demands a more complicated and expensive infrastructure. While enhancing the vertical scalability, there must be a trade-off to be considered between decision goals and the use of more hardware equipment.

Future research should concentrate on finding ways for boosting both vertical and horizontal scalability without compromising other LPWAN requirements like device cost. Developing approaches that work across all protocols, rather

than just one LPWAN, would be of particular importance. Innovative and inexpensive physical layer approaches, development of low-cost hardware, and improved hardware architecture to improve performances are all potential options to boost scalability. Further, as technology progresses and powerful hardware becomes less expensive, all sorts of scalability issues will be automatically eliminated.

B. HYBRID LPWAN DESIGN

In real-world circumstances, a single LPWAN cannot meet all network needs such as coverage, data throughput, and cost. As a result, commercial entities can adopt IoT technologies using hybrid designs. For deployment in remote places, the LPWAN satellite hybrid network is an open subject of research.

C. RESOURCE ALLOCATION

In an LPWAN design, the network server and backend devices are tasked with allocating a number of resources so that they can appropriately perform network operations. AI & ML algorithms can help network servers improve their ability to maximize bandwidth, coding rates, and data rates, among other challenges. Thorough research is needed in integrating AI & ML techniques with LPWANs for improving overall performance.

D. INDUSTRIAL GRADE COMMUNICATION

Most LPWANs face significant hurdles when it comes to industrial applications, which have common limitations in terms of timeliness, sustained data rate, and dependability. Jitter performance of LPWANs has not been investigated. For successful network resource usage, a guaranteed and sustained data rate with little network overhead and zero latency needs to be provided. This is especially important in an industrial setting, where multipath and multi-reflected receptions due to surrounding metallic surfaces and dense huge structures make reliable communication difficult.

E. AUTHENTICATION, SECURITY, AND PRIVACY

For any communication system, authentication, security, and privacy are very crucial aspects. Cellular communications have proven authentication, security, and privacy by using Subscriber Identity Module (SIM), which makes cellular device identification and authentication easier. Due to cost and energy constraints, LPWAN technologies use simplified communication systems that do not involve SIM-based identification. As a result, techniques providing equivalent or superior authentication for LPWAN technologies are necessary. Provision for frequent Over-The-Air (OTA) updates is also necessary to ensure that updated security is provided to end devices and are not left vulnerable to privacy issues for a long period. Most of the LPWAN solutions are at risk due to a lack of proper support for OTA updates.

Increased security frequently necessitates greater bandwidth, storage, or processing power, therefore any defense mechanism used for LPWAN solutions must take into account hardware and bandwidth limits. It is not sufficient to focus on building stronger approaches; instead, techniques for the unique issues that LPWANs face must also be developed. Establishing security procedures for a broader range of LPWAN technology is another area of investigation.

F. INTERFERENCE CONTROL

Interference resilient communication and effective spectrum sharing are the major technological and regulatory issues where different wireless technologies support a massive number of end devices that access the same frequency band for communication. As interference changes with time, space, and frequency the devices must adjust their transmission accordingly to get the lowest amount of interference while maintaining the highest level of reliability. The physical and MAC layer designs that make use of this variation to accommodate the coexistence of different technologies require further research. Regulatory agencies may also be required to create rules to allow for efficient sharing and collaboration among various technologies in the unlicensed bands.

G. HIGH DATA RATE MODULATION TECHNIQUES

To support large distance communication, LPWAN systems compromise on data rates. Some systems, particularly those operating in shared ISM bands using UNB modulation, have very poor data rates, and can only support the exchange of small messages restricting their business applications. Multiple modulation techniques for devices are necessary to satisfy bandwidth-hungry use cases. Devices can switch between several modulation schemes depending on application needs, enabling excellent energy efficiency, extended range, and high data rate all at the same time. To do so, applications require flexible and low-cost hardware that can support several physical layer modulation techniques, many of which can provide complimentary trade-offs to meet the data rate and coverage demands under investigation.

H. EMERGING TRANSMISSION MEDIA

While all the existing LPWAN technologies are based on the radio spectrum, newer technologies, such as Li-Fi, have arisen that use other parts of the spectrum. The visible light spectrum provides extremely high transmission speeds and scalability due to its wider bandwidth. On the other hand, using light as a transmission medium has its own set of difficulties. Li-Fi communications are presently inappropriate for LPWANs, as they are expensive, have a relatively small range, and cannot penetrate thick barriers.

Despite these obstacles, the light spectrum's potential for massive speed and scalability makes it worth investigating as a transmission medium in future LPWAN implementations. Reducing the cost of light-based approaches, expanding

the range, and discovering innovative ways to overcome light's physical limitations are all research issues. The use of fast-spinning reflectors to refract light in the right direction, beam-forming light, and producing inexpensive light sensors are all examples of problems that need to be investigated.

I. COEXISTENCE OF LPWAN WITH OTHER WIRELESS TECHNOLOGIES

Every use case has its own set of requirements, which can change over time in different scenarios. The operation of applications can be optimized if the end device connectivity is augmented with LPWAN technologies in addition to cellular or wireless LANs. By combining the advantages of each technology, conflicting goals such as wide-area coverage, ultra-low latency, high throughput, and energy efficiency can be fulfilled. To investigate the benefits of such opportunistic and contextual network access, system-level research is required.

A hybrid 5G-based ecosystem with multiple wireless technologies, including but not restricted to LPWANs, is required to meet the demands of all classes of applications. Due to the difference in various wireless technologies, developing a coexistence method for the 5G-based ecosystem is a massive undertaking. Hybrid architecture, mobility, security, the coexistence of LPWANs with other wireless technologies, and interoperability between LPWAN technologies are all hurdles to integrating non-cellular LPWANs and other wireless technologies. Thorough research is required in integrating LPWANs with other wireless technologies.

IX. CONCLUSION

In this paper, we reviewed how all LPWAN technologies have different design objectives such as wide coverage, improved energy efficiency, low cost, high scalability, efficient interference management, better integration, and QoS. Multiple design choices are taken into account when designing LPWAN technologies, such as unlicensed/licensed spectrum, modulation techniques, channel access methods, operational frequency and bandwidth, signal diversity approaches, duplexity, and business model, depending on how vigorously these objectives are achieved.

When comparing the capabilities of each LPWAN to the design objectives, a clear trade-off between power consumption, communication range, and data throughput is observed. Though systems operating in the unlicensed band are more scalable, less expensive, and more energy-efficient, duty cycling constraints limit their viability for critical applications. The findings of our investigation were in sync with our intuitive understanding of the effectiveness of LPWAN technologies in various applications. They were corroborated by extensive analysis of technical aspects, published findings, and observations from widespread implementation and design decisions taken in all different LPWAN technologies. LPWAN requirements are prioritized differently by each company for different applications depending on available resources and budget.

Finally, this paper can be used to determine which LPWANs are best suited for various industrial and research applications. The detailed technical specifications, benefits, and limitations of various LPWAN technologies, as well as their comparison and implementation in various applications, are provided in this paper. The use cases presented in this article will assist readers in evaluating various options and determining which one best suits their needs.

We have highlighted a series of major topics for future work based on our investigation with respect to present and future LPWAN technologies. Scalability, security, interference management, and coexistence with other wireless technologies are just a few of the topics that require more research for large-scale commercial implementation and the effective operation of IoT services. We look forward to future advancements in LPWAN technologies that will broaden the scope of integrating a massive number of IoT devices.

REFERENCES

- [1] C. Scuro, P. F. Sciammarella, F. Lamonaca, R. S. Olivito, and D. L. Carni, "IoT for structural health monitoring," *IEEE Instrum. Meas. Mag.*, vol. 21, no. 6, pp. 4–14, Dec. 2018.
- [2] T. Shahgholi, A. Sheikhamadi, K. Khamforoosh, and S. Azizi, "LPWAN-based hybrid backhaul communication for intelligent transportation systems: Architecture and performance evaluation," *EURASIP J. Wireless Commun. Netw.*, vol. 2021, no. 1, pp. 1–17, Dec. 2021.
- [3] N. Islam, B. Ray, and F. Pasandideh, "IoT based smart farming: Are the LPWAN technologies suitable for remote communication?" in *Proc. IEEE Int. Conf. Smart Internet Things (SmartIoT)*, Aug. 2020, pp. 270–276.
- [4] R. O. Andrade and S. G. Yoo, "A comprehensive study of the use of LoRa in the development of smart cities," *Appl. Sci.*, vol. 9, no. 22, p. 4753, Nov. 2019. [Online]. Available: <https://www.mdpi.com/2076-3417/9/22/4753>
- [5] W. Xu, J. Zhang, J. Y. Kim, W. Huang, S. S. Kanhere, S. K. Jha, and W. Hu, "The design, implementation, and deployment of a smart lighting system for smart buildings," *IEEE Internet Things J.*, vol. 6, no. 4, pp. 7266–7281, Aug. 2019.
- [6] (2016). *Number of IoT-Devices 2015–2025*. [Online]. Available: <https://www.statista.com/statistics-471264/iot-number-of-connected-devices-worldwide/>
- [7] F. Gu, J. Niu, L. Jiang, X. Liu, and M. Atiquzzaman, "Survey of the low power wide area network technologies," *J. Netw. Comput. Appl.*, vol. 149, Jan. 2020, Art. no. 102459.
- [8] M. Centenaro, L. Vangelista, A. Zanella, and M. Zorzi, "Long-range communications in unlicensed bands: The rising stars in the IoT and smart city scenarios," *IEEE Wireless Commun.*, vol. 23, no. 5, pp. 60–67, Oct. 2016.
- [9] U. Raza, P. Kulkarni, and M. Sooriyabandara, "Low power wide area networks: An overview," *IEEE Commun. Surveys Tuts.*, vol. 19, no. 2, pp. 855–873, 2nd Quart., 2017.
- [10] *IEEE Standard for Low-Rate Wireless Networks*, IEEE Standard 802.15.4-2015 (Revision of IEEE Standard 802.15.4-2011), 2016, pp. 1–709.
- [11] Q. M. Qadir, T. A. Rashid, N. K. Al-Salihi, B. Ismael, A. A. Kist, and Z. Zhang, "Low power wide area networks: A survey of enabling technologies, applications and interoperability needs," *IEEE Access*, vol. 6, pp. 77454–77473, 2018.
- [12] B. Foubert and N. Mitton, "Long-range wireless radio technologies: A survey," *Future Internet*, vol. 12, no. 1, p. 13, Jan. 2020. [Online]. Available: <https://www.mdpi.com/1999-5903/12/1/13>
- [13] A. Ikpehai, B. Adebisi, K. M. Rabie, K. Anoh, R. E. Ande, M. Hammoudeh, H. Gacanian, and U. M. Mbanaso, "Low-power wide area network technologies for Internet-of-Things: A comparative review," *IEEE Internet Things J.*, vol. 6, no. 2, pp. 2225–2240, Apr. 2019.
- [14] K. Mekki, E. Bajica, F. Chaxela, and F. Meyer, "A comparative study of LPWAN technologies for large-scale IoT deployment," *ICT Exp.*, vol. 5, no. 1, pp. 1–7, Jan. 2018.
- [15] B. S. Chaudhari, M. Zennaro, and S. Borkar, "LPWAN technologies: Emerging application characteristics, requirements, and design considerations," *Future Internet*, vol. 12, no. 3, p. 46, Mar. 2020. [Online]. Available: <https://www.mdpi.com/1999-5903/12/3/46>
- [16] K. Mekki, E. Bajic, F. Chaxel, and F. Meyer, "Overview of cellular LPWAN technologies for IoT deployment: Sigfox, LoRaWAN, and NB-IoT," in *Proc. IEEE Int. Conf. Pervasive Comput. Commun. Workshops (PerCom Workshops)*, Mar. 2018, pp. 197–202.
- [17] B. Buurman, J. Kamruzzaman, G. Karmakar, and S. Islam, "Low-power wide-area networks: Design goals, architecture, suitability to use cases and research challenges," *IEEE Access*, vol. 8, pp. 17179–17220, 2020.
- [18] S.-H. Hwang and S.-Z. Liu, "Survey on 3GPP low power wide area technologies and its application," in *Proc. IEEE VTS Asia Pacific Wireless Commun. Symp. (APWCS)*, Aug. 2019, pp. 1–5.
- [19] R. S. Sinha, Y. Wei, and S.-H. Hwang, "A survey on LPWA technology: LoRa and NB-IoT," *ICT Exp.*, vol. 3, no. 1, pp. 14–21, Mar. 2017.
- [20] D. Ismail, M. Rahman, and A. Saifullah, "Low-power wide-area networks: Opportunities, challenges, and directions," in *Proc. Workshop Program., 19th Int. Conf. Distrib. Comput. Netw.*, Jan. 2018, pp. 1–6.
- [21] M. Chochul and P. Sevcik, "A survey of low power wide area network technologies," in *Proc. 18th Int. Conf. Emerg. eLearning Technol. Appl. (ICETA)*, Nov. 2020, pp. 69–73.
- [22] M. S. Bali, K. Gupta, K. K. Bali, and P. K. Singh, "Towards energy efficient NB-IoT: A survey on evaluating its suitability for smart applications," *Mater. Today, Proc.*, vol. 49, pp. 3227–3234, Jan. 2022.
- [23] M. L. Liya and D. Arjun, "A survey of LPWAN technology in agricultural field," in *Proc. 4th Int. Conf. I-SMAC (IoT Social, Mobile, Anal. Cloud) (I-SMAC)*, Oct. 2020, pp. 313–317.
- [24] J. P. S. Sundaram, W. Du, and Z. Zhao, "A survey on LoRa networking: Research problems, current solutions, and open issues," *IEEE Commun. Surveys Tuts.*, vol. 22, no. 1, pp. 371–388, Jun. 2020.
- [25] K. O. A. Alimi, K. Ouahada, A. M. Abu-Mahfouz, and S. Rimer, "A survey on the security of low power wide area networks: Threats, challenges, and potential solutions," *Sensors*, vol. 20, no. 20, p. 5800, Oct. 2020. [Online]. Available: <https://www.mdpi.com/1424-8220/20/20/5800>
- [26] G. Peruzzi and A. Pozzobon, "A review of energy harvesting techniques for low power wide area networks (LPWANs)," *Energies*, vol. 13, no. 13, p. 3433, Jul. 2020. [Online]. Available: <https://www.mdpi.com/1996-1073/13/13/3433>
- [27] R. Kufakunesu, G. P. Hancke, and A. M. Abu-Mahfouz, "A survey on adaptive data rate optimization in LoRaWAN: Recent solutions and major challenges," *Sensors*, vol. 20, no. 18, p. 5044, Sep. 2020. [Online]. Available: <https://www.mdpi.com/1424-8220/20/18/5044>
- [28] A. Lavric and V. Popa, "Internet of Things and LoRa low-power wide-area networks: A survey," in *Proc. Int. Symp. Signals, Circuits Syst. (ISSCS)*, Jul. 2017, pp. 1–5.
- [29] Y. H. Tehrani, Z. Fazel, and S. M. Atarodi, "A survey of two dominant low power and long range communication technologies," *J. Inf. Syst. Telecommun.*, vol. 6, no. 2, pp. 60–66, 2018.
- [30] A. Khalifeh, K. A. Aldahdouh, K. A. Darabkh, and W. Al-Sit, "A survey of 5G emerging wireless technologies featuring LoRaWAN, sigfox, NB-IoT and LTE-M," in *Proc. Int. Conf. Wireless Commun. Signal Process. Netw. (WiSPNET)*, Mar. 2019, pp. 561–566.
- [31] F. Muteba, K. Djouani, and T. Olwal, "A comparative survey study on LPWA IoT technologies: Design, considerations, challenges and solutions," *Proc. Comput. Sci.*, vol. 155, pp. 636–641, Jan. 2019.
- [32] Y. Song, J. Lin, M. Tang, and S. Dong, "An internet of energy things based on wireless LPWAN," *Engineering*, vol. 3, no. 4, pp. 460–466, 2017.
- [33] M. Chen, Y. Miao, Y. Hao, and K. Hwang, "Narrow band Internet of Things," *IEEE Access*, vol. 5, pp. 20557–20577, 2017.
- [34] M. Anedda, C. Desogus, M. Murrioni, D. D. Giusto, and G.-M. Muntean, "An energy-efficient solution for multi-hop communications in low power wide area networks," in *Proc. IEEE Int. Symp. Broadband Multimedia Syst. Broadcast. (BMSB)*, Jun. 2018, pp. 1–5.
- [35] A. Froytlog, M. A. Haglund, L. R. Cenkeramaddi, and B. Beferull-Lozano, "Design and implementation of a long-range low-power wake-up radio and customized DC-MAC protocol for LoRaWAN," in *Proc. IEEE Int. Conf. Adv. Netw. Telecommun. Syst. (ANTS)*, Dec. 2019, pp. 1–5.
- [36] T. Adame, A. Bel, and B. Bellalta, "Increasing LPWAN scalability by means of concurrent multiband IoT technologies: An Industry 4.0 use case," *IEEE Access*, vol. 7, pp. 46990–47010, 2019.

- [37] M. Rahman and A. Saifullah, "Integrating low-power wide-area networks for enhanced scalability and extended coverage," *IEEE/ACM Trans. Netw.*, vol. 28, no. 1, pp. 413–426, Feb. 2020.
- [38] A. Tiurlikova, N. Stepanov, and K. Mikhaylov, "Method of assigning spreading factor to improve the scalability of the LoRaWAN wide area network," in *Proc. 10th Int. Congr. Ultra Modern Telecommun. Control Syst. Workshops (ICUMT)*, Nov. 2018, pp. 1–4.
- [39] N. Benghabrit and M. Kaddour, "Optimizing the capacity of cognitive radio networks with power control and variable spectrum allocation," *Transp. Telecommun. J.*, vol. 19, no. 2, pp. 128–139, Jun. 2018.
- [40] S. Gao, G. Y. Tian, X. Dai, M. Fan, X. Shi, J. Zhu, and K. Li, "A novel distributed linear-spatial-array sensing system based on multichannel LPWAN for large-scale blast wave monitoring," *IEEE Internet Things J.*, vol. 6, no. 6, pp. 9679–9688, Dec. 2019.
- [41] J. Fadeyi, E. D. Markus, and A. M. Abu-Mahfouz, "Technology coexistence in LPWANs—A comparative analysis for spectrum optimization," in *Proc. IEEE 28th Int. Symp. Ind. Electron. (ISIE)*, Jun. 2019, pp. 2244–2249.
- [42] Y. Mo, C. Goursaud, and J.-M. Gorce, "Uplink multiple base stations diversity for UNB based IoT networks," in *Proc. IEEE Conf. Antenna Meas. Appl. (CAMA)*, Sep. 2018, pp. 1–4.
- [43] A. Alexiou and M. Haardt, "Smart antenna technologies for future wireless systems: Trends and challenges," *IEEE Commun. Mag.*, vol. 42, no. 9, pp. 90–97, Sep. 2004.
- [44] F. Babich, M. Comisso, M. D'Orlando, and L. Manià, "Interference mitigation on WLANs using smart antennas," *Wireless Pers. Commun.*, vol. 36, no. 4, pp. 387–401, Mar. 2006.
- [45] A. Oluwole and V. Srivastava, "Smart antenna at 300 MHz for wireless communications," *African J. Comput. ICT*, vol. 8, no. 3, pp. 193–201, 2015.
- [46] E. Sallum, N. Pereira, M. Alves, and M. Santos, "Improving quality-of-service in LoRa low-power wide-area networks through optimized radio resource management," *J. Sensor Actuator Netw.*, vol. 9, no. 1, p. 10, Feb. 2020. [Online]. Available: <https://www.mdpi.com/2224-2708/9/1/10>
- [47] A. Dvornikov, P. Abramov, S. Efmov, and L. Voskov, "QoS metrics measurement in long range IoT networks," in *Proc. IEEE 19th Conf. Bus. Informat. (CBI)*, Jul. 2017, pp. 15–20.
- [48] U. Coutaud and B. Tourancheau, "Channel coding for better QoS in LoRa networks," in *Proc. 14th Int. Conf. Wireless Mobile Comput., Netw. Commun. (WiMob)*, Oct. 2018, pp. 1–9.
- [49] J. Courjault, B. Vrigneau, O. Berder, and M. R. Bhatnagar, "A computable form for LoRa performance estimation: Application to Ricean and Nakagami fading," *IEEE Access*, vol. 9, pp. 81601–81611, 2021.
- [50] O. J. Pandey, T. Yuvaraj, J. K. Paul, H. H. Nguyen, K. Gundepudi, and M. K. Shukla, "Improving energy efficiency and QoS of LPWANs for IoT using Q-learning based data routing," *IEEE Trans. Cognit. Commun. Netw.*, vol. 8, no. 1, pp. 365–379, Mar. 2022.
- [51] J. Rubio-Aparicio, F. Cerdan-Cartagena, J. Suardiaz-Muro, and J. Ybarra-Moreno, "Design and implementation of a mixed IoT LPWAN network architecture," *Sensors*, vol. 19, no. 3, p. 675, Feb. 2019. [Online]. Available: <https://www.mdpi.com/1424-8220/19/3/675>
- [52] N. Naik, "LPWAN technologies for IoT systems: Choice between ultra narrow band and spread spectrum," in *Proc. IEEE Int. Syst. Eng. Symp. (ISSE)*, Oct. 2018, pp. 1–8.
- [53] L. Zhang, A. Ijaz, P. Xiao, and R. Tafazolli, "Channel equalization and interference analysis for uplink narrowband Internet of Things (NB-IoT)," *IEEE Commun. Lett.*, vol. 21, no. 10, pp. 2206–2209, Oct. 2017.
- [54] S. Liu, F. Yang, J. Song, and Z. Han, "Block sparse Bayesian learning-based NB-IoT interference elimination in LTE-advanced systems," *IEEE Trans. Commun.*, vol. 65, no. 10, pp. 4559–4571, Oct. 2017.
- [55] S. Liu, L. Xiao, Z. Han, and Y. Tang, "Eliminating NB-IoT interference to LTE system: A sparse machine learning-based approach," *IEEE Internet Things J.*, vol. 6, no. 4, pp. 6919–6932, Aug. 2019.
- [56] B. Vejlggaard, M. Lauridsen, H. Nguyen, I. Z. Kovács, P. Mogensen, and M. Sorensen, "Interference impact on coverage and capacity for low power wide area IoT networks," in *Proc. IEEE Wireless Commun. Netw. Conf. (WCNC)*, Mar. 2017, pp. 1–6.
- [57] B. Reynders, W. Meert, and S. Pollin, "Range and coexistence analysis of long range unlicensed communication," in *Proc. 23rd Int. Conf. Telecommun. (ICT)*, May 2016, pp. 1–6.
- [58] J. Haxhibeqiri, A. Shahid, M. Saelens, J. Bauwens, B. Jooris, E. De Poorter, and J. Hoebeker, "Sub-gigahertz inter-technology interference. How harmful is it for LoRa?" in *Proc. IEEE Int. Smart Cities Conf. (ISC)*, Sep. 2018, pp. 1–7.
- [59] C. Orfanidis, L. M. Feeney, M. Jacobsson, and P. Gunningberg, "Investigating interference between LoRa and IEEE 802.15.4g networks," in *Proc. IEEE 13th Int. Conf. Wireless Mobile Comput., Netw. Commun. (WiMob)*, Oct. 2017, pp. 1–8.
- [60] Y. Rama and M. A. Özpınar, "A comparison of long-range licensed and unlicensed LPWAN technologies according to their geolocation services and commercial opportunities," in *Proc. 18th Medit. Microw. Symp. (MMS)*, Oct. 2018, pp. 398–403.
- [61] W. Badawy, A. Ahmed, S. Sharf, R. A. Elhamied, M. Mekky, and M. A. Elhamied, "On flashing over the air 'FOTA' for IoT appliances—An ATMEL prototype," in *Proc. IEEE 10th Int. Conf. Consum. Electron. (ICCE-Berlin)*, 2020, pp. 1–5.
- [62] R. Ratasuk, D. Zhou, and R. Sinha, "LTE-M coexistence within 5G new radio carrier," in *Proc. IEEE 3rd 5G World Forum (5GWF)*, Sep. 2020, pp. 224–228.
- [63] A. Høglund, G. A. Medina-Acosta, S. N. K. Veedu, O. Liberg, T. Tirronen, E. A. Yavuz, and J. Bergman, "3GPP release-16 preconfigured uplink resources for LTE-M and NB-IoT," *IEEE Commun. Standards Mag.*, vol. 4, no. 2, pp. 50–56, Jun. 2020.
- [64] *XXX Simpozijum O Novim Tehnologijama U Posrbanskom I Telekomunikacijom Saobraćaju—PosTel 2012*, Belgrade, Serbia, Dec. 2012.
- [65] S. C. Gaddam and M. K. Rai, "A comparative study on various LPWAN and cellular communication technologies for IoT based smart applications," in *Proc. Int. Conf. Emerg. Trends Innov. Eng. Technol. Res. (ICETIETR)*, Jul. 2018, pp. 1–8.
- [66] M. I. Nashiruddin and A. A. F. Purnama, "NB-IoT network planning for advanced metering infrastructure in surabaya, sidoarjo, and gresik," in *Proc. 8th Int. Conf. Inf. Commun. Technol. (ICOICT)*, Jun. 2020, pp. 1–6.
- [67] S. Lippuner, B. Weber, M. Salomon, M. Korb, and Q. Huang, "EC-GSM-IoT network synchronization with support for large frequency offsets," in *Proc. IEEE Wireless Commun. Netw. Conf. (WCNC)*, Apr. 2018, pp. 1–6.
- [68] M. Korb, S. Willi, B. Weber, H. Kröll, A. Traber, S. Altörfer, D. Tschopp, J. Rogin, E. Dornbierer, M. Salomon, S. Lippuner, L. Wu, and Q. Huang, "A dual-mode NB-IoT and EC-GSM RF-SoC achieving –128-dBm extended-coverage and supporting OTDOA and A-GPS positioning," in *Proc. IEEE 44th Eur. Solid State Circuits Conf. (ESSCIRC)*, Sep. 2018, pp. 286–289.
- [69] S. Tabbane, "IoT network planning," Developing ICT Ecosyst. Harness IoTs, Int. Telecommun. Union Asia-Pacific Centre Excellence (ITU ASP CoE), Bangkok, Thailand, Dec. 2016.
- [70] E. Sisinni, P. Ferrari, D. Fernandes Carvalho, S. Rinaldi, P. Marco, A. Flammini, and A. Depari, "LoRaWAN range extender for industrial IoT," *IEEE Trans. Ind. Informat.*, vol. 16, no. 8, pp. 5607–5616, Aug. 2020.
- [71] J.-T. Lim and Y. Han, "Spreading factor allocation for massive connectivity in LoRa systems," *IEEE Commun. Lett.*, vol. 22, no. 4, pp. 800–803, Apr. 2018.
- [72] A. Farhad, D.-H. Kim, D. Kwon, and J.-Y. Pyun, "An improved adaptive data rate for LoRaWAN networks," in *Proc. IEEE Int. Conf. Consum. Electron. Asia (ICCE-Asia)*, Nov. 2020, pp. 1–4.
- [73] F. Petitgrand, T.-H. Peng, J. Wey, S. Sabihuddin, and V. M. Balijepalli, "LPWAN technologies: Design and implementation of WEIGHTLESS enabled AMI in tai-power," in *Proc. IEEE Power Energy Soc. Innov. Smart Grid Technol. Conf. (ISGT)*, Feb. 2021, pp. 1–5.
- [74] B. Despatis-Paquette, L. Rivest, and R. Pellerin, "Connectivity validation for indoor IoT applications with weightless protocol," in *Proc. 15th Int. Conf. Distrib. Comput. Sensor Syst. (DCOSS)*, May 2019, pp. 393–399.
- [75] R. A. Abbas, A. Al-Sherbaz, A. Bennecer, and P. Picton, "A new channel selection algorithm for the weightless-n frequency hopping with lower collision probability," in *Proc. 8th Int. Conf. Netw. Future (NOF)*, Nov. 2017, pp. 171–175.
- [76] W. Ayoub, F. Nouvel, A. E. Samhat, J.-C. Prevotet, and M. Mroue, "Overview and measurement of mobility in DASH7," in *Proc. 25th Int. Conf. Telecommun. (ICT)*, Jun. 2018, pp. 532–536.
- [77] W. Ayoub, A. E. Samhat, F. Nouvel, M. Mroue, and J.-C. Prevotet, "Internet of mobile things: Overview of LoRaWAN, DASH7, and NB-IoT in LPWANs standards and supported mobility," *IEEE Commun. Surveys Tuts.*, vol. 21, no. 2, pp. 1561–1581, 2nd Quart., 2019.
- [78] W. Ayoub, M. Mroue, F. Nouvel, A. E. Samhat, and J.-C. Prevotet, "Towards IP over LPWANs technologies: LoRaWAN, DASH7, NB-IoT," in *Proc. 6th Int. Conf. Digit. Inf., Netw., Wireless Commun. (DINWC)*, Apr. 2018, pp. 43–47.

- [79] H. Kim, S. C. Cho, Y. Lee, and J. Shin, "Performance analysis of NB-IoT system according to operation mode," in *Proc. Int. Conf. Inf. Commun. Technol. Converg. (ICTC)*, Oct. 2019, pp. 876–878.
- [80] B. Chaudhari and S. Borkar, "Design considerations and network architectures for low-power wide-area networks," in *LPWAN Technologies for IoT and M2M Applications*. Amsterdam, The Netherlands: Elsevier, 2020, pp. 15–35.
- [81] (2021). *Nb-Fi—The IoT Standard*. [Online]. Available: <https://waviot.com/technology/nb-fi-specification/>
- [82] *Qowiso, Discover IoT*. Accessed: Oct. 5, 2021. [Online]. Available: <https://www.qowiso.com/en/ecosystem/internet-of-things/#lpwan-network>
- [83] H. Zemrane, Y. Baddi, and A. Hasbi, "Ehealth smart application of WSN on WWAN," in *Proc. 2nd Int. Conf. Netw., Inf. Syst. Secur.*, 2019, pp. 1–8.
- [84] M. El-Aasser, A. Gasser, M. Ashour, and T. Elshabrawy, "Performance analysis comparison between LoRa and frequency hopping-based LPWAN," in *Proc. IEEE Global Conf. Internet Things (GCIoT)*, Dec. 2019, pp. 1–6.
- [85] W. Wang, S. L. Capitaneanu, D. Marinca, and E.-S. Lohan, "Comparative analysis of channel models for industrial IoT wireless communication," *IEEE Access*, vol. 7, pp. 91627–91640, 2019.
- [86] (2021). *MIoTy*. [Online]. Available: <https://www.ti.com/tool/MIOTY#tech-docs>
- [87] Z. Ahmad, S. J. Hashim, F. Z. Rokhani, S. A. R. Al-Haddad, A. Sali, and K. Takei, "Quaternion model of higher-order rotating polarization wave modulation for high data rate M2M LPWAN communication," *Sensors*, vol. 21, no. 2, p. 383, Jan. 2021. [Online]. Available: <https://www.mdpi.com/1424-8220/21/2/383>
- [88] K. E. Nolan, M. Y. Kelly, M. Nolan, J. Brady, and W. Guibene, "Techniques for resilient real-world IoT," in *Proc. Int. Wireless Commun. Mobile Comput. Conf. (IWCMC)*, Sep. 2016, pp. 222–226.
- [89] V. Tikhvinskiy, G. Bochechka, A. Gryazev, and A. Aitmagambetov, "Comparative analysis of QoS management and technical requirements in 3GPP standards for cellular IoT technologies," *J. Telecommun. Inf. Technol.*, vol. 2, no. 2018, pp. 41–47, Jul. 2018.
- [90] M. I. Hossain and J. I. Markendahl, "Comparison of LPWAN technologies: Cost structure and scalability," *Wireless Pers. Commun.*, vol. 121, no. 7, pp. 887–903, 2021.
- [91] M. Lauridsen, H. Nguyen, B. Vejlgard, I. Z. Kovacs, P. Mogensen, and M. Sorensen, "Coverage comparison of GPRS, NB-IoT, LoRa, and SigFox in a 7800 km² area," in *Proc. IEEE 85th Veh. Technol. Conf. (VTC Spring)*, Jun. 2017, pp. 1–5.
- [92] L. H. Trinh, V. X. Bui, F. Ferrero, T. Q. K. Nguyen, and M. H. Le, "Signal propagation of LoRa technology using for smart building applications," in *Proc. IEEE Conf. Antenna Meas. Appl. (CAMA)*, Dec. 2017, pp. 381–384.
- [93] Y. Perwej, M. K. Omer, O. E. Sheta, H. A. M. Harb, and M. S. Adrees, "The future of Internet of Things (IoT) and its empowering technology," *Int. J. Eng. Sci.*, vol. 2019, Mar. 2019, Art. no. 20192.
- [94] Cisco. (2020). *Cisco Annual Internet Report (2018–2023) White Paper*. [Online]. Available: <https://www.cisco.com/c/en/us/solutions/collateral/executive-perspectives/annual-internet-report/white-paper-c11-741490.html>
- [95] (Mar. 9, 2020). *Cisco Annual Internet Report*. [Online]. Available: <https://www.cisco.com/c/en/us/solutions-executive-perspectives/annual-internet-report/air-highlights.html#>
- [96] A. K. Pundir, J. D. Jagannath, and L. Ganapathy, "Improving supply chain visibility using IoT-Internet of Things," in *Proc. IEEE 9th Annu. Comput. Commun. Workshop Conf. (CCWC)*, Jan. 2019, pp. 0156–0162.
- [97] S. Lu and X. Wang, "Toward an intelligent solution for perishable food cold chain management," in *Proc. 7th IEEE Int. Conf. Softw. Eng. Service Sci. (ICSESS)*, Aug. 2016, pp. 852–856.
- [98] M. Grabia, T. Markowski, J. Mruczkiewicz, and K. Plec, "Design of a DASH7 low power wireless sensor network for Industry 4.0 applications," in *Proc. IEEE Int. Conf. RFID Technol. Appl. (RFID-TA)*, Sep. 2017, pp. 254–259.
- [99] A. Valach and D. Macko, "Exploration of the LoRa technology utilization possibilities in healthcare IoT devices," in *Proc. 16th Int. Conf. Emerg. eLearning Technol. Appl. (ICETA)*, Nov. 2018, pp. 623–628.
- [100] S. Monarch. (2021). *The Need for Monarch*. [Online]. Available: <https://build.sigfox.com/monarch>
- [101] L. Alliance. *LoRaWAN 1.1 Specifications*. Accessed: Oct. 11, 2017. [Online]. Available: <https://lora-alliance.org/wp-content/uploads/2020/11/lorawantm/specification/v1.1.pdf>
- [102] W. Ayoub, A. E. Samhat, F. Nouvel, M. Mroue, and J.-C. Prévotet, "Internet of mobile Things: Overview of LoRaWAN, DASH7, and NB-IoT in LPWANs standards and supported mobility," *IEEE Commun. Surveys Tuts.*, vol. 21, no. 2, pp. 1561–1581, 2nd Quart., 2018.
- [103] N. Havard, S. McGrath, C. Flanagan, and C. MacNamee, "Smart building based on Internet of Things technology," in *Proc. 12th Int. Conf. Sens. Technol. (ICST)*, Dec. 2018, pp. 278–281.
- [104] T. Ameloot, P. Van Torre, and H. Rogier, "LoRa indoor performance: An office environment case study," in *Proc. Int. Appl. Comput. Electromagn. Soc. Symp.-China (ACES)*, Jul. 2018, pp. 1–2.
- [105] C. Yoon, M. Huh, S.-G. Kang, J. Park, and C. Lee, "Implement smart farm with IoT technology," in *Proc. 20th Int. Conf. Adv. Commun. Technol. (ICTACT)*, Feb. 2018, pp. 749–752.
- [106] O. Elijah, T. A. Rahman, I. Orikumhi, C. Y. Leow, and M. N. Hindia, "An overview of Internet of Things (IoT) and data analytics in agriculture: Benefits and challenges," *IEEE Internet Things J.*, vol. 5, no. 5, pp. 3758–3773, Oct. 2018.
- [107] M. G. Ikhsan, M. Y. A. Saputro, D. A. Arji, R. Harwahyu, and R. F. Sari, "Mobile LoRa gateway for smart livestock monitoring system," in *Proc. IEEE Int. Conf. Internet Things Intell. Syst. (IOTAIS)*, Nov. 2018, pp. 46–51.
- [108] G. Valecce, P. Petrucci, S. Strazzella, and L. A. Grieco, "NB-IoT for smart agriculture: Experiments from the field," in *Proc. 7th Int. Conf. Control, Decis. Inf. Technol. (CoDIT)*, Jun. 2020, pp. 71–75.
- [109] T. Sondrol, B. Jalaian, and N. Suri, "Investigating LoRa for the internet of battlefield things: A cyber perspective," in *Proc. IEEE Mil. Commun. Conf. (MILCOM)*, Oct. 2018, pp. 749–756.
- [110] M. Durisic, Z. Tafa, G. Dimic, and V. Milutinovic, "A survey of military applications of wireless sensor networks," in *Proc. Medit. Conf. Embedded Comput.*, Jan. 2012, pp. 196–199.
- [111] P. Silva, V. Kaseva, and E. Lohan, "Wireless positioning in IoT: A look at current and future trends," *Sensors*, vol. 18, no. 8, p. 2470, Jul. 2018. [Online]. Available: <https://www.mdpi.com/1424-8220/18/8/2470>
- [112] S. Anand and S. K. Routray, "Issues and challenges in healthcare narrowband IoT," in *Proc. Int. Conf. Inventive Commun. Comput. Technol. (ICICCT)*, Mar. 2017, pp. 486–489.
- [113] A. Mdhaffar, T. Chaari, K. Larbi, M. Jmaiel, and B. Freisleben, "IoT-based health monitoring via LoRaWAN," in *Proc. IEEE 17th Int. Conf. Smart Technol. (EUROCON)*, 2017, pp. 519–524.
- [114] J. Ortín, M. Cesana, and A. Redondi, "Augmenting LoRaWAN performance with listen before talk," *IEEE Trans. Wireless Commun.*, vol. 18, no. 6, pp. 3113–3128, Apr. 2019.

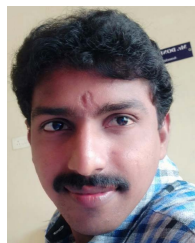

NAGA SRINIVASARAO CHILAMKURTHY

received the B.Tech. degree in electronics and communication engineering from the E. V. M. College, Affiliated to Jawaharlal Nehru Technological University, Kakinada, Andhra Pradesh, India, in 2011, and the M.Tech. degree from the Swarnandhra College, Narsapur, Andhra Pradesh, in 2014. He is currently pursuing the Ph.D. degree with the Department of Electronics and Communication Engineering, SRM University AP, Andhra Pradesh, India. He worked as an Assistant Professor in various engineering colleges in Andhra Pradesh, Affiliated with JNTU-K. His research interests include wireless sensor networks, low-power wide-area networks, small-world networks, and applying machine learning and reinforcement learning techniques in the context of wireless networks for cyber-physical systems and the IoT applications.



OM JEE PANDEY (Senior Member, IEEE) received the Ph.D. degree from the Department of Electrical Engineering, Indian Institute of Technology Kanpur, Kanpur, India, in January 2019. He worked as a Postdoctoral Fellow with the Communications Theories Research Group, Department of Electrical and Computer Engineering, University of Saskatchewan, Saskatoon, Canada. He is currently working as an Assistant Professor with the Department of Electronics Engineering, Indian Institute of Technology BHU Varanasi, Uttar Pradesh, India. His research interests include wireless sensor networks, low-power wide-area networks, unmanned aerial vehicle networks, mobile and pervasive computing, cyber-physical systems, the Internet of Things, cloud and fog computing, UAV-assisted optical communications, and social networks. He serves as a Regular Reviewer for various reputed journals of IEEE, including the IEEE TRANSACTIONS ON VEHICULAR TECHNOLOGY, the IEEE TRANSACTIONS ON WIRELESS COMMUNICATIONS, the IEEE TRANSACTIONS ON COMMUNICATIONS, the IEEE TRANSACTIONS ON GREEN COMMUNICATIONS AND NETWORKING, the IEEE TRANSACTIONS ON NETWORK AND SERVICE MANAGEMENT, IEEE INTERNET OF THINGS JOURNAL, IEEE SYSTEMS JOURNAL, and IEEE ACCESS.



LINGA REDDY CENKERAMADDI (Senior Member, IEEE) received the master's degree in electrical engineering from the Indian Institute of Technology, New Delhi, India, in 2004, and the Ph.D. degree in electrical engineering from the Norwegian University of Science and Technology, Trondheim, Norway, in 2011. He worked with Texas Instruments in mixed-signal circuit design before joining the Ph.D. Program at NTNU. After finishing his Ph.D., he worked in radiation imaging for an atmosphere space interaction monitor (ASIM mission to International Space Station) at the University of Bergen, Norway, from 2010 to 2012. He is currently the Group Leader of the Autonomous and Cyber-Physical Systems (ACPS) Research Group and working as a Professor at the University of Agder, Campus Grimstad, Norway. He is the principal and the co-principal investigator of many research grants from the Norwegian Research Council. He has coauthored over 100 research publications that have been published in prestigious international journals and standard conferences. His main research interests include cyber-physical systems, autonomous systems, and wireless embedded systems. He is also a member of the editorial boards of various international journals, as well as the technical program committees of several IEEE conferences.



ANIRBAN GHOSH received the bachelor's degree from Jadavpur University, Kolkata, India, in 2010, the master's degree from the National Institute of Technology, Durgapur, India, in 2012, and the Ph.D. degree from North Dakota State University, Fargo, ND, USA, in 2018. He worked as an Assistant Professor at the KIIT University, Bhubaneswar, India, in 2012; and as a Wireless System Engineer with Clifton Technologies LLC, USA, in 2018. He is currently working as an

Assistant Professor at SRM University AP, Andhra Pradesh, India. While working at Clifton Technologies LLC, he was a part of the team that deployed the patented 220 MHz IoT Network. His current research interests include secrecy capacity determination using information theory, the various IoT applications and solutions, channel measurement and modeling, and biomedical image processing.



HONG-NING DAI (Senior Member, IEEE) received the Ph.D. degree in computer science and engineering from the Department of Computer Science and Engineering, The Chinese University of Hong Kong. He is currently an Associate Professor with the Department of Computer Science, Hong Kong Baptist University, Hong Kong. His current research interests include the Internet of Things, big data, and blockchain technology. He is also a Senior Member of the Association for Computing Machinery (ACM). He has served as an Associate Editor/Editor for the IEEE TRANSACTIONS ON INDUSTRIAL INFORMATICS, IEEE SYSTEMS JOURNAL, IEEE ACCESS, *Ad Hoc Networks*, and *Connection Science*.

...