



# **An Assessment of Hydro Aluminium Structures' Supply Chain to Audi**

**Requirements, Development and Improvements to an  
International Automotive Supply Chain**

**Master Thesis in  
Industrial and Information Management**

**by**

***Terje Daastøl  
&  
Håvard Stensrud***

**Agder University College**

**Grimstad, May 2006**

## Preface

This Master Thesis is the final entrenchment in our University Degree in Industrial and Information Management. It has been carried out in association with Hydro Aluminium Structures Raufoss (HARA) and Faculty of Economic and Social Science, Department of Industrial Economics at Agder University College during the spring of 2006.

The Thesis is a part of the project “Innovations in Hydro’s value chain of the production of extrusion based car components”, partially financed by Norwegian Research Council, with Roy Jacobsen at Hydro Aluminium Structures Raufoss as the Project Manager.

The subject of the Thesis is based on the IND501 Supply Chain Management course. We had to acquire a great deal of new knowledge since we did not attend the relevant courses during the fall of 2005. However, as we studied at University of New South Wales, Fall 05, we have implemented and utilized this experience to our advantage in writing this Thesis. Acquiring this knowledge, and working with HARA has aroused profound appreciation for this area and we have had very much fun during our work.

We would like to thank our supervisor Bo Terje Kalsaas, Professor at Agder University College, and our contact person Geir Stangjordet, Logistics Consultant and Project Responsible for the ‘Pikes Peak’ logistics at HARA, for elementary information, valid feedback and guidance towards a final result we are pleased with and very proud of.

We would also like to thank every single one we have interviewed throughout the spring and a tap on the back to our fellow students for exciting and enlightening conversations.

Happy reading!  
Grimstad, May 2006

---

Terje Daastøl

&

---

Håvard Stensrud

[By this signature we acknowledge that this is our own work and that the work of others are referred to whenever appropriate]

## **Abstract**

This Thesis is written for Hydro Aluminium Structures Raufoss (HARA), a bumper manufacturer to the automotive industry. The research project assesses the 'Pikes Peak' supply chain with vendor managed inventory in order to document and find improvement possibilities. The development of this supply chain has proved to be complex and met several difficulties and delays. At present the bumpers are in series production but with an imperfect supply chain. The supply chain involves, in addition to HARA, a supplier, a logistic operator that handles warehousing and simple assembling, forwarding agent, a distribution company and a car manufacturer located in different European countries. The title of this Thesis is:

**“An Assessment of Hydro Aluminium Structures' Supply Chain to Audi -  
Requirements, Development, and Improvements to an International Automotive  
Supply Chain”**

This title, or problem definition, is then again divided into three problem objectives that include documentation and improvement possibilities of the supply chain design, the project development and contractual agreements.

Relevant theories concerning Supply Chain Management and Information Management are reviewed in the theoretical framework to create a foundation for discussion along with the empirical data. Empirical data are collected from HARA and their forwarding agent mainly through interviews and discussion. The theoretical framework includes basic underlying theories like Principal Agency theory, Transaction cost and Network Theory to concepts like VMI, 3PL and Lean Thinking in addition to a review of two supply chain management tools.

First a detailed Business Process Map is prepared to address the flow of material, information and financial transactions in the supply chain to get an overview of the different processes that constitutes the supply chain. The Business Process Map generates

a process documentation which can be used as an illustration of the current state, basis for improvement investigation and increase task programmability. The Business Process map includes full 'drill down' into all of HARA's processes. By investigating each interaction in detail the research has revealed that the supply chain handles information sharing at an inadequate level. Different reporting times and lack of procedures have already caused major deviations in inventory reports and are occupying extra resources which are not in accordance with Lean Principles. These issues are suggested improved by the use of agreed contracted reporting procedures and the use of real-time information sharing technology like RFID. Other main findings include inefficient information sharing between the different parts in the supply chain and unnecessary safety stocks where direct loading at the production plant should be considered.

Further, the project development and design process are assessed with respect to the logistic. The logistic development procedures are compared with present supply chain management tools and improvement possibilities are discovered with employment of these tools. There currently exist guidelines to develop and implement a new functional supply chain, but these guidelines have proven to be just about adequate, with respect to the detail in which they are constituted and defined, and also a lack of use has been discovered. This is found to be a main explanation for the delays in the 'Pikes Peak' project.

The contractual agreements between HARA and its partners in this supply chain are assessed. All current contract-types are identified to be in accordance with theoretical principles and propositions, and are assessed to help mitigate risk. There are, however, potential risks which are identified through a risk assessment employed for this supply chain. By comparing HARA's standard logistic agreement with Odette's *Guide to Logistic Agreement* several important potential improvements have been suggested. Employing these propositions could reduce the problems occurred in the 'Pikes Peak' project in the future.

The overall risk in the supply chain is assessed to be relatively low, mainly due to the mitigation measures. Nevertheless, research has identified several risk potentials that should be analyzed regularly. The risk analysis is based on information from interviews, previous supply chain cases, contractual aspects, theoretical principles and numerical information. Preliminary to the implementation, HARA was very cautious and regarded their supplier as a potential risk. This supplier has, through research, been assessed to bear little immediate risk. In an event of an adverse situation there is potential for the supplier acting in their own interest but this risk is, to some degree, mitigated with an outcome-based contract.

## Table of Contents

<b>1</b>	<b>Introduction.....</b>	<b>1</b>
1.1	Problem Discussion .....	2
1.2	Demarcation .....	2
1.3	Disposition .....	3
<b>2</b>	<b>Methodology .....</b>	<b>5</b>
<b>3</b>	<b>Theoretical Framework.....</b>	<b>14</b>
3.1	Theoretical Principles .....	14
3.1.1	Principal-Agent Theory .....	14
3.1.2	Resource-Based View .....	17
3.1.3	Transaction Cost .....	18
3.1.4	Network Theory .....	20
3.2	The Supply Chain .....	21
3.2.1	Supply Chain Risk Management .....	25
3.3	Management Concepts and Techniques.....	28
3.3.1	Lean Thinking.....	28
3.3.2	Vendor Managed Inventory (VMI).....	30
3.3.3	Third-Party Logistics and External Logistics Provider .....	34
3.3.4	Concurrent Engineering.....	35
3.3.5	Supply Chain Management Tools.....	36
3.4	Information systems.....	42
3.4.1	EDI.....	43
3.4.2	SAP and ERP systems .....	44
<b>4</b>	<b>The Studied Case.....</b>	<b>46</b>
4.1	Hydro Aluminium Structures Raufoss.....	46
4.2	Audi.....	46
4.3	Kirchhoff.....	47
4.4	Schnellecke .....	47
4.5	Hydro Slovakia .....	48
4.6	Multisped .....	48
4.7	Organizational Structure of the studied case .....	48
<b>5</b>	<b>Empirical Evidence.....</b>	<b>50</b>
5.1	Contracts .....	50
5.2	Supply Chain Flows.....	52
5.3	Project development phase .....	54
<b>6</b>	<b>Discussion.....</b>	<b>58</b>
6.1	Project Structure and Performance .....	58
6.1.1	Project Process Map.....	58
6.1.2	Processes.....	60
6.1.3	Interactions.....	69

6.1.4	Summary .....	77
6.1.5	Implementation Issues .....	78
6.1.6	Cost and Effect.....	81
6.2	Project Development.....	82
6.2.1	Present Supply Chain Management tool.....	83
6.2.2	Other Supply Chain Management tools.....	87
6.3	Contractual Agreements.....	89
6.4	Supply Chain Risk .....	95
6.4.1	Worksheet Description.....	95
6.4.2	Risk Analysis .....	96
<b>7</b>	<b>Results &amp; Conclusions .....</b>	<b>101</b>
<b>8</b>	<b>Abbreviations .....</b>	<b>104</b>
<b>9</b>	<b>References.....</b>	<b>105</b>
<b>10</b>	<b>Appendix.....</b>	<b>107</b>

## Table of Figures

Figure 2-1 - Step 1 (Churchill, 2005)	5
Figure 2-2 - Step 2 (Churchill, 2005)	6
Figure 2-3 - Step 3 (Churchill, 2005)	7
Figure 2-4 - Step 4 (Churchill, 2005)	8
Figure 2-5 - Step 5 (Churchill, 2005)	9
Figure 2-6 - Step 6 (Churchill, 2005)	11
Figure 3-1 - The Supply Chain	21
Figure 3-2 - Supply Chain Management [Mentzer et. al, 2001]	24
Figure 3-3 - Risk assessment of Supply Chain Performance	26
Figure 3-4 - The Balancing Act [Zylstra, 2006]	30
Figure 3-5 - Traditional Ordering Process vs. VMI	31
Figure 3-6 - Third-Party Logistics	34
Figure 3-7 - SCOR-model [www.supply-chain.org]	39
Figure 3-8 - SCOR-model [www.supply-chain.org]	40
Figure 3-9 - SCOR – ‘Drill down’	41
Figure 3-10 - Basic Logic Flow, inputs & outputs [www.supply-chain.org]	41
Figure 3-11 - Traditional Information Sharing Versus EDI	43
Figure 3-12 - Business areas and activities	44
Figure 4-1 - Audi Q7 [www.Audi.com]	47
Figure 4-2 – The Supply Chain’s Structure	49
Figure 5-1 - Flow of Material	52
Figure 5-2 - Flow of Information	53
Figure 5-3 - Flow of Money	54
Figure 5-4 - Core Processes	55
Figure 5-5 - Project Team Organization	55
Figure 5-6 - Logistic Project Status Report	56
Figure 6-1 - Project Process Map	59
Figure 6-2 - Receive Forecast	61
Figure 6-3 - Production Plan	62
Figure 6-4 - Material Resource Plan	63
Figure 6-5 - Replenish Stock	64
Figure 6-6 - Check Quantity and Price	65
Figure 6-7 - Check Quantity	66
Figure 6-8 - Spare Parts	67
Figure 6-9 - MRP Description	68
Figure 6-10 - PPM a)	69
Figure 6-11 - PPM b)	71
Figure 6-12 - PPM c)	72
Figure 6-13 - Daily Deviations	73
Figure 6-14 - Use of RFID	75
Figure 6-15 - PPM d)	77
Figure 6-16 - RFID Tags [compilation from www.rfidjournal.com]	78
Figure 6-17 - RFID Portal [www.symbol.com]	79
Figure 6-18 - Efficiency of the Measures	82



Figure 6-19 - Change Handling Process \_\_\_\_\_ 86

## **Table of Tables**

Table 2-1 - Four Design Tests (Yin, 2003, p.34) _____	12
Table 3-1 - Agency Theory overview [Extracted from Eisenhardt, 1989] _____	15
Table 3-2 - Principal-Agency Theory [Extracted from Eisenhardt, 1989] _____	17
Table 3-3 - MMOG/LE Grading _____	38
Table 3-4 - Drill down [www.supply-chain.org] _____	42
Table 5-1 - Contract summary _____	51
Table 6-1 - Improvements _____	78
Table 6-2 - LPSR instructions _____	84
Table 6-3 - Identification of theoretical favored contract type in the HARA - Schnellecke relation _____	91
Table 6-4 - Identification of theoretical favored contract type in the HARA - Kirchhoff relation _____	92
Table 6-5 - Identification of theoretical favored contract type in the OEM – HARA relation _____	93

# 1 Introduction

Increasing complexity and competition in automotive supply chains have created a host of global logistic challenges that the suppliers to the automotive industry are facing. They have to manage their supply chains by finding creative ways to keep inventories lean, improve velocity, and cut costs to meet manufacturer demands and the suppliers are looking to new supply chain management strategies for solutions.

Hydro Aluminium Structures Raufoss (HARA) is a supplier of aluminum bumpers to the automotive industry around the world. The plant is located in Raufoss, Norway making the challenge of managing their supply chains of major importance in order to be a competitive actor, due to high transport and logistic costs. One solution has been to make use of consignment warehouses close to the customer, where HARA controls the customer replenishment. HARA has now several consignment warehouses which have improved their competitiveness but also generated new challenges. No detailed logistic documentation exists on these solutions at HARA and is one of the reasons why this Thesis was initiated.

HARA is responsible for delivery of the rear bumper with mounting brackets to the new Audi Q7 through a consignment warehouse. At present, the Audi Q7 is in series production and the performance of this particular supply chain is the field of investigation. This includes documentation of present solution, improvement strategies and risk assessment.

The supply chain has not been established without problems, and HARA has not been satisfied with the way the project has developed. Based on this, a project development analysis has been included in the Thesis and also an assessment of two supply chain management tools that could have been employed when designing the supply chain. In addition to this analysis, the contractual agreements will be compared and analyzed on basis of underlying theories to predict the actors expected behavior and to justify contract

types. The risk element in the chain has been of some concern to the management at HARA and will therefore be assessed through a risk analysis.

## **1.1 Problem Discussion**

The title of this Thesis is:

### **“An Assessment of Hydro Aluminium Structures' Supply Chain to Audi - Requirements, Development, and Improvements to an International Automotive Supply Chain”**

The title encapsulates these problem objectives:

1. Map, describe and assess current flows in the supply chain of material, information and financial transactions and suggest areas of improvement.
2. Assess project development guidelines and performance with respect to the logistics.
3. Can relevant theory and contractual aspects predict the supply chain partners' behavior and suggest an appropriate contract type?

These problem objectives create the basis for the performed research that will contribute to the assessment of Hydro Aluminium Structures' supply chain to Audi.

## **1.2 Demarcation**

The Thesis has been limited by the availability of information outside HARA. Information from and about suppliers in Poland and Slovakia is reduced as a result of language barriers. English is not the business language in these countries and has reduced the possibility of verification (or rejection) of collected information at HARA. The information about these companies is therefore limited to the information on their internet homepages and information provided by HARA.

The Thesis has a clear focus on the logistic part of the studied case, and will only aim to analyze the Logistic Departments involvement in the development phase. In-dept focus is kept on the documentation, verification and improvement possibilities in the current supply chain. A shallower but still a thorough approach has been chosen for the other parts of the Thesis mainly due to the time limit but also according to desired perspective from HARA, HiA and the authors.

### **1.3 Disposition**

#### **Section 2:**

This section provides an introduction to the selected research method the Thesis employ to solve the problems. This section also includes an introduction to the business process mapping tool.

#### **Section 3:**

This section will render new empiric knowledge by means of the selected theoretical framework. The theoretical framework in this Thesis exists of various aspects concerning Supply Chain Management. The theoretical content ranges from basic underlying supply chain theories and supply chain management concepts and techniques, to basic knowledge of information systems. The intention is to provide the reader with enough basic knowledge to form a foundation for later discussion.

#### **Section 4:**

This section introduces the specific case study with a presentation of the different actors involved in this case's supply chain, and a brief explanation of the supply chain's organizational structure.

#### **Section 5:**

Collected empirical information concerning the case will be presented in this section by describing the flow of material, information and money. Contracts and project development procedures are also demonstrated.

**Section 6:**

This section will provide discussion about the case tied up against relevant theory from section 3. This includes both documentation of the present supply chain in form of a Business Process Map and suggested improvements based on the interactions. In this section the risk aspect is analyzed and justified. The project development phase, guidelines and contractual aspects are also discussed.

**Section 7:**

Concluding remarks will review and attempt to answer the problem objectives defined in section 1.1 together with an evaluation of the project.

## 2 Methodology

This section provides a review of the selected methodology in this Thesis, from the very beginning to the final product. Method, from the Greek *methodos*, means to follow a certain path towards a goal. A research design or method tells us how we should proceed to collect information and how this information should be analyzed and processed. Empirical research includes collecting, analyzing and interpreting data and is recognized by methodical thoroughness and openness [22].

Choice of research design and methodology has been vital for the final result of this Thesis and will therefore be described in detail with justification and test of validity and reliability.

The methodology has been greatly inspired and influenced by Yin [42] and we have chosen to follow Churchill's [7] (p. 40-43) research process steps when designing the project. This sequence of steps has been followed with individual customization in order to suit our project. Churchill's research process is illustrated in Figure 2-1 through Figure 2-6 and will be explained with regards to our project. Note that these steps are interrelated and was performed with great deal of iteration.

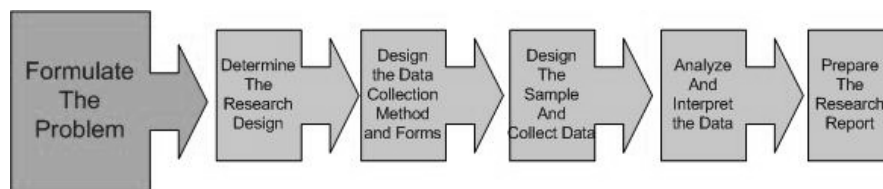

Figure 2-1 - Step 1 (Churchill, 2005)

The first part of a research process is to *formulate the problem* to be solved. This part includes specifying the objectives to undertake in order to precisely define the research problem. Not until the problem and objectives are clearly formulated can the process move on to the next stage.

Some of the objectives were briefly stated by our supervisor at HiA in cooperation with the Head of Logistics at HARA. These objectives were then discussed with the group members and more precisely objectives were worked out. The definitions are specific and are all based and limited of the case described.

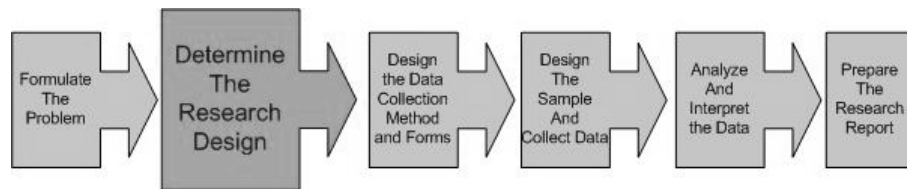

Figure 2-2 - Step 2 (Churchill, 2005)

The *research design* is a determination and a plan of how to solve the research objectives, from start to end. The research design will vary for different research problems and objectives. First, the research type should be stated and then the research design can be determined.

This Thesis is defined as a *cross-sectional examination* of a *case-study* [22]. The data is collected from a single case – the Audi Q7 supply chain – which gives us a great involvement in the processes and interactions in the case, but makes the results more difficult to generalize to suit other supply chains. Though it should be noted that the structure of this supply chain is similar to other solutions that HARA employ and some of the conclusions and documentations can be directly transferred and applied in other supply chains as well. The fact that this case study is a cross-sectional examination makes it difficult to determine the development over time but will only explain the variations at one point in time. We will in the research process act as informants, perform a post-evaluation and suggest improvements on an already working supply chain.

When the research type is defined the design can be decided. Churchill divides research design into three types: exploratory, descriptive and causal research. These three types are distinctive but can be used complementary throughout the research process.

Our problem definition was very vague in the beginning. *Exploratory* research, literature review and open interviews were used to gather information about the case. In addition to this, personal preferences and visions were discussed with both our supervisor and HARA personnel, which rendered a more precise problem definition to proceed with.

The research then entered a more *descriptive* research period where structured interviews and cross-sectional case study was carried out to describe the supply chain and project development. This produced a documentation of the supply of bumpers and how the project had developed. It also generated the theoretical framework of the Thesis.

*Causal research* was used to some extent later on in the problem research period, even though not in its normal sense. Here, cause-and-effect relationships were investigated to uncover improvement potentials in the supply chain. A causal research was also employed for the risk evaluation and contractual analysis to reveal how “X causes Y” based on human assumptions. In the contractual analysis theoretical and contractual aspects was used to explain actors’ behavior. It should be noted that no numerical experimental research was found necessary to meet the problem objectives.

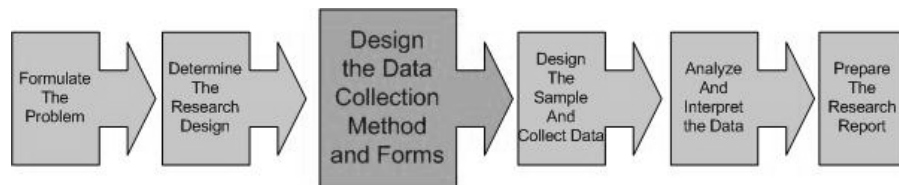

Figure 2-3 - Step 3 (Churchill, 2005)

When the research objectives, problem definition and research design are described and clearly specified, the next step is to define the type of data to collect and the methods to employ. The data types can split into Primary and Secondary data [7], while the methods often are divided into Qualitative and Quantitative methods [22].

Both primary and secondary data was necessary to collect in this Thesis. Secondary data gathered are company facts, financial status and RFID prices while primary data are data



collected concerning contract agreements, supply chain structure and project development.

Due to the flexibility of the problem objectives in this Thesis, only the *qualitative* method has been employed for data collection. It was important to let the informants talk as freely as possible in order to get the full perspective of the case and hear the different opinions without guiding them in any direction. Further, the collected data were based on the 'six sources of evidence' of Case Study Research identified by Yin. This Thesis utilizes three of these different sources, in addition to recommendations provided by our supervisor at HiA.

*Interviews* have been selected due to its immediate advantages such as directness and insightfulness. The technique has some drawbacks as it may be biased. Interviews have been performed with several process owners and involved personnel in an attempt to illuminate and reveal the actual configuration and performance of the supply chain, making it as accurate as possible.

*Documentation* has provided this Thesis with elemental information around supply chain concepts and techniques currently employed at HARA. It has also been a vital part of the theoretical and empirical framework of this Thesis. The Logistic Project Status Report and organizational hierarchal diagrams are such documents that have been important components in the information we have used. On the other hand, there might be biased selectivity of the retrieved information and the information itself may also be biased to some degree.

*Archival Records* have been assisting the documentation and providing the Thesis with additional information and particulars around the configuration of the current supply chain.

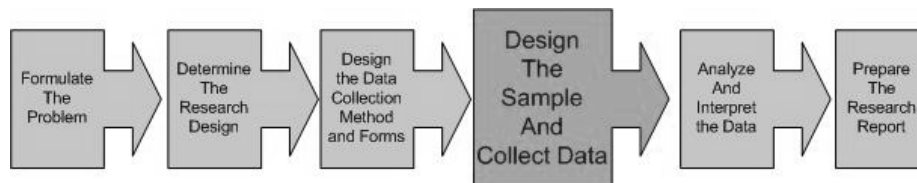

Figure 2-4 - Step 4 (Churchill, 2005)

The data collection method and form has now been chosen. The next step includes deciding a sample frame prior to data collection.

The theoretical framework of the Thesis is based on secondary sources such as books and articles selected by the authors or after discussion with our supervisor at HiA. We have chosen to use a large number of secondary sources, to provide a complete and a comprehensive theoretical foundation as possible and in an attempt to view theoretical principles from different perspectives. By drawing on theories from several perspectives we will better validate the chosen theories as well as provide depth to our theoretical framework.

The empirical foundation and collection is based on interviews of the involved employees at HARA and Multisped. These interviews have to great extent been face-to-face interviews with follow-up questions through e-mail and telephone. The same questions are asked to a multiple number of people to uncover different aspects and perspectives on the same topics. The interviews are performed with the use of comprehensive and structured interview guides with no fixed answers in order to let the interviewee answer freely. The selection of interview sources has been decided in collaboration with the Logistic Project Manager at HARA and our supervisor at HiA.

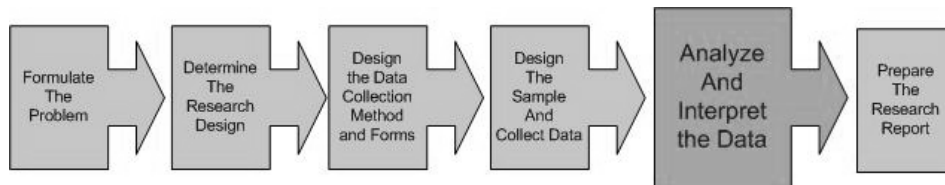

Figure 2-5 - Step 5 (Churchill, 2005)

An analysis of the data is done by summarizing the data, editing it and distributing all the gathered information with the purpose of finding the answers to the research objectives.

Because of the distinctive research objectives in this case, the analysis have been somewhat different. For the documentation and evaluation of the different flows the information gathered from the interviews have been compared and mapped in a Business Process Map. This map has then been reviewed several times by our supervisor at HiA

and our project manager at HARA, in order to create an accurate replica of the present state.

Business process mapping is a way to map a process (or a set of processes) to better understand how it works, increased task programmability and as a tool to efficiently find a way of improving a process. It illustrates how different actions interact and how they contribute to the final result. The development of the Business Process Map followed these four stages; process identification, information gathering, interview and measures, and analysis.

- *Process identification*, identification of events that initiates and triggers actions, divided into critical and supplementary processes from a customers view. It also provides a brief and superior process flow map.
- *Information gathering* stage gathers as much background information as possible to prepare for the interview stage. This is done by collecting data from the person that is responsible for the process and then work your way down. Information desired here is identification and description of the different sub processes, process and unit owners, and the work flow.
- The *interview* processes consists of talking to the people involved in the different processes and map every involvement. It is here important to let the interviewee talk as freely as possible in order to get their full view and involvement in the process. The mapping process must be very detailed and should be divided into sub maps or “drill downs”.
- *Analysis* gathers all data from processes, activities and units, and tries to develop this into one single product to get the complete view of how things are and how it could be done better.

The *project development evaluation* has used the collected information on this case's development in contrast with the existing guidelines at HARA. The guidelines are then compared with present Supply Chain Management tools.

Information about the contractual agreements is analyzed in contrast with the relevant theory presented in the Thesis' theoretical framework. The contractual information is gathered in form of written contracts but also orally presented information about the relationships and agreements.

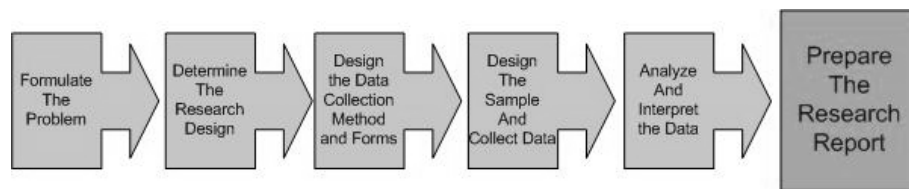

Figure 2-6 - Step 6 (Churchill, 2005)

The research report summarizes the research results, with conclusions and recommendations. This includes both the theoretical and the empirical foundations with discussion and evaluation. We have put great effort into making the report as clear and as accurate as possible so that it can be used by HARA as documentation, review of internal processes, to help building new contractual agreements (or assessing them further) and as a guide to implementation of suggested improvements.

### Quality of the Research Design

To ensure the quality of the empirical research of this case study Yin's Four Design Tests [42] has been employed. According to Yin this is a widely used test and the recommended case study tactic since it is more comprehensive than the standard "validity" and "reliability" concept. The four tests require explicit attention and the justification of each test will be explained followed by the performed test based on the empirical research performed in this Thesis represented by Table 2-1.

*Construct validity*: establish correct operational measures for the concepts being studied.

*Internal validity*: establish a causal relationship, whereby certain conditions are shown to lead to other conditions, as distinguished from spurious relationships (Causal Relation-

ships only).

*External validity*: establish the domain to which a study's findings can be generalized.

*Reliability*: demonstrate that the operations of a study – such as the data collection procedures – can be repeated, with the same result.

Test	Case Study Tactic	Performed Tactic / Comment
Construct Validity	<ul style="list-style-type: none"> <li>• Use Multiple sources of evidence</li> <li>• Establish chain of evidence</li> <li>• Have key informants review draft case study report</li> </ul>	<ul style="list-style-type: none"> <li>✓ The performed research has used several sources at HARA for information gathering and one of the partners in the supply chain.</li> <li>✓ Clear link between final conclusions, results and evidence</li> <li>✓ Supervisors at HARA and HiA have reviewed report draft continuously during the research period.</li> </ul>
Internal Validity	<ul style="list-style-type: none"> <li>• Do pattern-matching</li> <li>• Do explanation-matching</li> <li>• Address rival explanations</li> <li>• Use logic models</li> </ul>	<ul style="list-style-type: none"> <li>- No real pattern matched in the research</li> <li>✓ Empirically based behavior compared with expected behavior of supply chain parties</li> <li>✓ Rival explanations discussed when relevant</li> <li>- No logic model found necessary</li> </ul>
External Validity	<ul style="list-style-type: none"> <li>• Use theory in single-case studies</li> <li>• Use replication logic in multiple-case studies</li> </ul>	<ul style="list-style-type: none"> <li>✓ Theories are in great extent been used to support and explain the empirical research.</li> <li>- This is not a multiple-case study</li> </ul>
Reliability	<ul style="list-style-type: none"> <li>• Use study protocol</li> <li>• Develop case study database</li> </ul>	<ul style="list-style-type: none"> <li>✓ Study plan and structure extensively used during the research period</li> <li>✓ Structured interview guides and reports have been used for all interviews to document evidence and data collected. Interviews has been performed by two interviewers and same questions asked to several involved persons. Summary made for every single meeting.</li> </ul>

**Table 2-1 - Four Design Tests (Yin, 2003, p.34)**

✓ Performed

- Not performed

The Four Design Tests reveals that the research performed is highly valid and reliable.

Only Internal Validity reveals divergence from the performed research. This can be

explained by the fact that the research process has not employed causal research type in the normal sense as discussed earlier. It should, however, be noted that the information concerning processes and relations have only been collected from two of the involved parties, HARA and Multisped, and could, to some degree, be biased. This has, however, been considered and is also one of the reasons why several persons involved have been individually interviewed about the same topics. Even though this is a case specific research study, the results can to great extend be used for other supply chains at HARA also. The documentation, in form of BPM, and risk analysis are both made in order for HARA to employ these for all present and future chains.

### 3 Theoretical Framework

This section of the Thesis is dedicated to create a theoretical framework which will act as a foundation for the discussion that will follow. This section is a carefully selected mix of theoretical principles and concepts.

First, traditional theoretical principles will be addressed, followed by a presentation of the Supply Chain and Supply Chain Management. Then, concepts and techniques linked to the supply chain will be described, closing with the importance of information sharing and systems.

#### 3.1 Theoretical Principles

This sub-section is intended to introduce traditional theoretical principles needed in order to achieve a foundation for the discussion later in the Thesis. First, Principal-Agent Theory will be introduced, followed by a theoretical approach to Resource-Based View of a company. Then Transaction Cost Theory will be addressed prior to Network Theory.

##### 3.1.1 Principal-Agent Theory

In a relationship between different parties there is a Principal who delegates a service to an Agent that performs the service on the Principal's behalf. The parties can be companies, divisions, or people in an organization. However, in Supply Chain Management it concerns the relationship between two companies in the supply chain.

Each participant in a supply chain should think and act on behalf of the whole supply chain but often a relationship like this has potential risk [1], mainly due to:

- Prioritizing of own interests; *the agent and principal have different goals and values.*
- Information asymmetry; *the principal can not determine (difficult or expensive) if the agent has behaved appropriately.*

Conflicts, or preventing conflicts, are costly and can be referred to as Agency Cost [28]. It is impossible for the principal, at no cost, to ensure that the agent acts in the principal's best interest at all times. The Agency Cost includes monitoring the agent and developing and structuring contracts. Contracts in this context refer to the entire relationship between the agent and the principal and not only a piece of paper. Also included in the Agency Cost is the loss of output due to conflicts that exceeds the profit of the relationship [28].

To resolve the Agency problem the principal can add different incentives to the contract between the two parties to reduce the likelihood of undesired behavior. There are two types of contracts: Behavior-based contracts, also called Command-and-control, and Outcome-based or Incentive-based contracts. Theory propose that the Outcome-based contracts shifts the risk to the agent; only payment if the work leads to accepted results, while Behavior-based contracts places the risk on the principal since the agent will get paid no matter the outcome.

<b>Key Ideas</b>	Principal-Agent relationships should reflect efficient organization of information and risk-bearing costs
<b>Unit of analysis</b>	Contract between principle and agent
<b>Human assumptions</b>	Self-Interest, Bounded rationality, Risk aversion
<b>Organizational Assumptions</b>	Partial goal conflict among participants Efficiency as the effectiveness criterion Information asymmetry between principal and agent
<b>Information Assumption</b>	Information as a purchasable commodity
<b>Contracting problems</b>	Agency (moral hazard and adverse selection) Risk sharing
<b>Problem domain</b>	Relationships in which the principal and agent have partly differing goals and risk preferences

**Table 3-1 - Agency Theory overview [Extracted from Eisenhardt, 1989]**

The Agency Theory, as foreshadowed above in Table 3-1, is concerned around describing a relationship between a principal and an agent that has a potential of developing problems due to contradictory goals or different attitudes towards risk. Table 3-1 also sums up the basic assumptions Agency Theory is based on with contract or mechanism as the unit of analysis to define the relationship. The focus is how to obtain



the optimal, most efficient contract – outcome or behavior-based – between the principal and the agent assuming self interest and risk aversion.

In literature different outcomes have been discussed based on the underlying behavior and assumptions in order to find the optimal contract. Two theories have been generated and gathered in two slightly different approaches. These are the Positivist-Agency Theory and the Principal-Agency Theory. Positivist-Agency Theory discusses two different governance mechanisms to solve the agency problem and two propositions are made [13];

- 1) *When the contract between the principal and agent is outcome based, the agent is more likely to behave in the interest of the principal.*

These contracts co-align the preferences of agents with those of the principal because the rewards for both depend on the same actions and results.

- 2) *When the principal has information to verify agent behavior, the agent is more likely to behave in the interest of the principal.*

Because of the information system, the agent realizes that deceiving the principal is difficult and is therefore more likely to act in the principal's best interest.

The Principal-Agent Theory, on the other hand, is a more general approach that can be applied in many agency relationships. It strives to find the most efficient contract under different assumptions such as; goal conflict, an easily measured outcome, and an agent that is more risk averse than the principal and vice versa. Reasons contributing to the possibility that the agent will not act in the interest of the principal, are found to be *Moral Hazard*; the lack of effort from the agent, and *Adverse Selection*; the fact that the agent tries to misrepresent (overestimate) own abilities.

The Principal-Agent Theory tries to offer a trade-off between (a) the cost of measuring behavior and (b) the cost of measuring outcomes and transferring risk to the agent [13]. The model relies on several assumptions and, based on these, proposes different outcomes as summarized in Table 3-2 on the next page.

Assumption	Proposition
Unobservable behavior	Information systems are positively related to behavior-based contracts and negatively related to outcome-based contracts
	Outcome uncertainty is positively related to behavior-based contracts and negatively related to outcome-based contracts
Risk attitudes	The risk aversion of the <u>agent</u> is positively related to behavior-based contracts and negatively related to outcome-based contracts
	The risk aversion of the <u>principal</u> is negatively related to behavior-based contracts and positively related to outcome based contract
The goal conflict	The goal conflict between principal and agent is negatively related to behavior based contracts and positively related to outcome-based contracts
Programmability	Task programmability is positively related to behavior-based contracts and negatively related to outcome-based
Measurability of the outcome	Outcome measurability is negatively related to behavior-based contracts and positively related to outcome-based contracts
Period of relationships	The length of the agency relationship is positively related to behavior-based contracts and negatively related to outcome-based contracts

**Table 3-2 - Principal-Agency Theory [Extracted from Eisenhardt, 1989]**

### 3.1.2 Resource-Based View

The Resource-Based View theory is closely related to the competitive advantage and competitive strength of the company. A company's resources include financial, physical, human, and organizational assets employed to develop, manufacture, and deliver products or services to its customers [37]. These strategic resources share four characteristics: *valuable*, *rare*, *imperfectly imitable*, and *no easy substitute* [29]. Resources with these characteristics can enable the company to sustain and protect competitive advantage. This is, however, not possible unless the resource is *valuable*. They are valuable in the sense of enabling the company to exploit opportunities and neutralize threats.

If the resource is not *rare*, many competitors can obtain it. Thus, the advantages obtained through utilizing the resource can not be sustained because possessing the resource is more a necessity for being in the market than a competitive advantage. Strategic resources are also difficult to *imitate*. This is especially the case if the resources are a combination of intangible and tangible assets. Finally, strategic resources must be difficult to *substitute*. If substitution is possible, a competitive advantage can not be sustained. For example, skills and trust between a company and its suppliers are intangible assets that are hard to substitute.

Identifying and developing these strategic resources are vital for achieving and sustaining a competitive advantage for the company [37].

### 3.1.3 Transaction Cost

“A transaction occurs when a goods or service is transferred across a technologically separate interface” [41]. The cost incurred by this transaction is referred to as *Transaction Cost*, and the theory investigates the different transactions within a company to determine the efficiency of modes of exchange [37].

Decision-makers must weigh up the production and transaction costs associated with executing a transaction within their companies (‘insourcing’) versus the production and transaction costs associated with executing the transaction in the market (outsourcing) [2]. Transaction cost is related to buying and selling, but also information exchange and payment flows [38]

Williamson [41] operates with two predicted human behaviors: *Bounded rationality* and *Opportunism*. Bounded rationality denotes that a human can not be assumed to be capable of, or possessing the resources to consider every possible output that a transaction may incur. While opportunism implies that a human will further its own self-interest.

Williamson recommends establishing appropriate *safeguards*, (refer to; contract incentives in Agency Theory), to ensure that the other party will not take advantage of the situation. They may take two forms; *legal ordering* and *private ordering*. The former denotes that the parties enter into a legal contract covering as many aspects of the

relationship as possible. The latter presumes that the parties will attempt to attain a balance of reciprocity thru private negotiations and agreements.

Williamson [41] elaborates further with three environmental factors that contribute to transaction costs:

*Uncertainty.* Uncertainty aggravates the problems that arise because of bounded rationality and opportunism.

*Small number trading.* If only a small number of actors exist in a marketplace, a party in a transaction may have difficulty disciplining the other parties in the transaction by the possibility of withdrawal and use of alternative actors in the marketplace.

*Asset specificity.* A certain transaction may require an investment. The company who has invested will incur a loss if the company that has not invested withdraws from the transaction.

Asset specificity is important because it means that future trades are tied to this transaction (sunk costs) when specifics about the trader become important in deciding who to trade with. Asset specificity can be related to site, physical asset, and human asset (i.e. learned knowledge as a result of the transaction).

"The reason asset specificity is critical is that, once an investment has been made, buyer and seller are effectively operating in a bilateral (or at least quasi-bilateral) exchange relation for a considerable period thereafter."

If *asset specificity* and *uncertainty* increases, it is more likely that decision-makers will choose a firm-based governance structure (in-sourcing/make), omitting to leave the transactions to the market.

If the transaction *frequency* increases, the advantage of employing market based governance structures (outsourcing/buy) will decrease as the costs of firm-based governance structures can be amortized via further instances of the transaction [41]. This is also, obviously, the choice when possessing *strategic resources* as earlier described in the Resource-Based View of the firm.

### 3.1.4 Network Theory

A much used definition of supply chain management is “The management of upstream and downstream relationships with suppliers and customers to deliver superior customer value at less cost to the supply chain as a whole” (Christopher in [37]). Thus, one needs to establish a network with all the other firms in the supply chain in order to care about the chain as a whole. In other words, it is not only important to influence the direct actors, but also the indirect actors through the direct actors.

Network Theory assumes that a firm's relationship with other firms often represents the firm's most valuable resources due to the access to complementary resources in the other firms. But it is also important to let others utilize the companies own resources. To do this one will have to look at the company from the outside and see if the knowledge can be used in a relationship with others. This can be seen as an important asset for each firm in a relationship [15].

An industrial network consists of actors, resources and activities. The capabilities of the actors are measured by the resources they control and the activities they execute. Resources in this context mean everything and anything that helps adding value to the end product. It is a fundamental assumption that all actors show mutual trust and openness towards each other in order to obtain the best result possible for the network

A relation arises when two or more firms interact with each other. This can be done in two ways; through an exchange process, or an adaptation process. The former occurs when two firms transfer one resource to the other by the means of another resource, while the latter is more of a collaborative alteration of activities in order to achieve a more efficient utilization of the resources. The exchanges create connections and each exchange is always related to other exchanges as a part of a whole [17]. This will often lead to a stronger relationship between the two and can be seen as a signal of a mutual trust [37].

Different firms in the network have different abilities to influence the other firms' actions in the network. This ranking is referred to as the *Power Structure* of the network. This is

strongly contributing to the development and shaping of the network together with common interests and differing resources. The power structure decides the position the different firms hold in the network, and thus, plays a role in the developing of new interactions and contracts. This strategic identity is formed and developed through interaction between the different actors.

It is important to note that a network is dynamic in nature, it is never stable or in balance. A strong, long lasting relation will never reach equilibrium but will constantly be moving and changing [15]. It can therefore be said that network relations are stable and dynamic at the same time. The constant interactions between the actors help develop new resources, and shift the centre of attention on how to utilize its own activities and resources towards the other actors' activities and resources.

### 3.2 The Supply Chain

To understand what Supply Chain Management is, it is necessary to first explain the Supply Chain as illustrated by Figure 3-1. By means of an analogy the authors will attempt to describe the actions necessary to achieve successful Supply Chain Management (SCM).

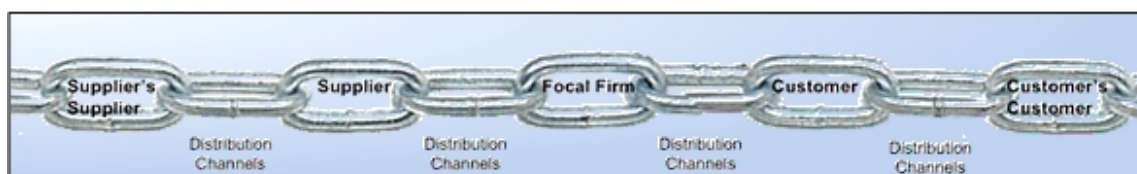

Figure 3-1 - The Supply Chain

A supply chain is much like a river, with products and services flowing down it instead of water. Companies are located along the riverbed, providing the river with more and more water – representing the value adding processes. If the company recognizes its position by the river and that the river's volume and velocity is determined not only by that one company's input of water, but also the other companies both upstream and downstream, the company possesses a *Supply Chain Orientation* (SCO) [30]. Whether the company

has a SCO or not, the supply chain will still exist. However, if the company does not recognize its position and the strategic implications of the supply chain which they are a part of, any management will not be possible. Thus, without the *orientation* the *management* is impossible. Furthermore, if only that single company has a SCO the river as a whole will not benefit. It is only when a number of companies along the riverbed adopt SCO and actively manage the resources of the river one can say that the whole river is managed. Similarly, not before every company in a supply chain adopts this *orientation* and actively manages it, it can be a *managed* supply chain. Hence, a supply chain may be defined as; a set of three or more entities directly involved in the upstream and downstream flows of products and services, finances, and/or information from a source to a customer [30].

Thus, exerting the above definition of supply chain, Supply Chain Management can roughly be explained as; *the things we do to influence the behavior of the river – or the supply chain – to get the results we desire*. This description will form the basis for further elaboration of Supply Chain Management as a concept.

Already in 1958 Forrester identified key management issues and illustrated the dynamics of factors associated with SCM. He said that;

*“There will come general recognition of the advantage enjoyed by the pioneering management who have been the first to improve their understanding of the interrelationships between separate company functions and between the company and its markets, its industry, and the national economy”*

[Forrester in Mentzer et al., 2001, [30]].

Porter [34] identifies two types of competitive advantage; *cost leadership* and *differentiation*. He emphasizes that competitive advantage grows fundamentally out of the customer value a firm creates, and aims to establish a profitable and sustainable position against the forces that determine industry competition. Porter's value chain model is an important consideration whereby the primary activities are directly involved

in creating and bringing value to the customer, and the support activities facilitate and enhance the primary activities. Porter claims that this is critical for a firm to develop competitive advantage. Expanding this idea – activities performed generates the advantage – to the whole supply chain, added with the supply chain definition and SCO brings us closer to explaining the concept of supply chain management

Simchi-Levi et al. defined SCM more specifically as follows:

*“Supply chain management is a set of approaches utilized to efficiently integrate suppliers, manufacturers, warehouses, and stores, so that merchandise is produced and distributed at the right quantities, to the right location, and at the right time, in order to minimize system wide cost while satisfying service level requirements.”*

[D. Simchi-Levi, et.al. 2003, [36]]

This definition encapsulates the management and control of activities necessary to enable a company to achieve value adding processes. Further, Mentzer et al. have described SCM as:

*“the systemic, strategic coordination of the traditional business functions and the tactics across these business functions within a particular company and across business within the supply chain, for the purpose of improving the long term performance of the individual companies and the supply chain as a whole.”*

[Mentzer et al. 2001, [30]]

They compiled a guide for implementation in the form of Figure 3-2 on the succeeding page, and to remind that the main focus in SCM is customer value and satisfaction, and ultimately, competitive advantage. The representation originates from Porter's value chain model but is modified to fit the management of the whole supply chain.



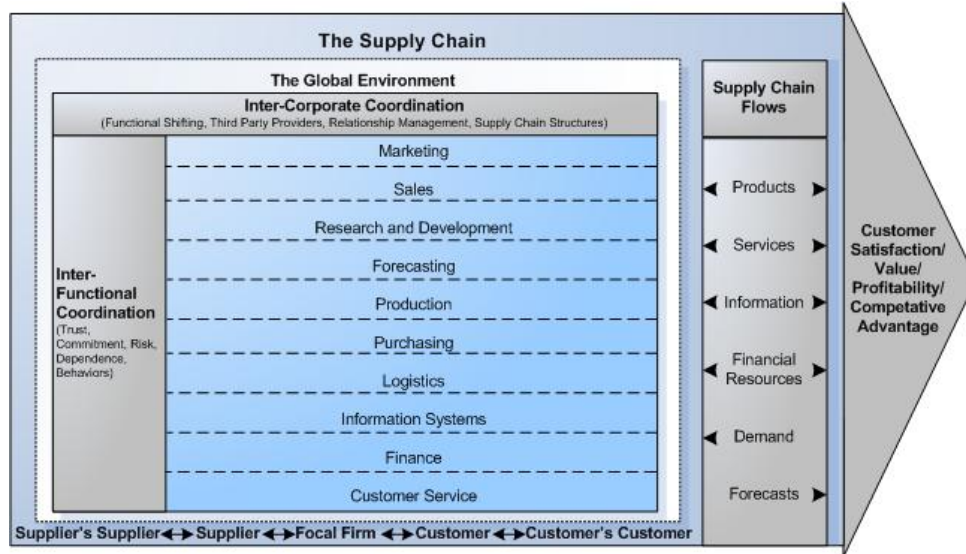

Figure 3-2 - Supply Chain Management [Mentzer et. al, 2001]

The conceptual model formulated by Mentzer et al. depicts the supply chain as a pipeline viewed from the side, showing the directional flows in the supply chain (products, services, information, etc.). The traditional business functions of marketing, sales, research and development, forecasting, etc., accomplish and manage these flows from supplier's supplier through the customer's customer to eventually provide the end customer with value and satisfaction.

Holcomb (in [30]) further elaborates that the objective of SCM should be to synchronize all supply chain activities (marketing, sales, etc.) to create customer value.

Cooper et al. (in [30]) argues that the most crucial factor for successful management of the supply chain is frequent information sharing. Thus, implementing techniques/tools such as SAP may prove to be a necessity for any company taking part in any supply chain. Mentzer et al. [30] stress that open sharing of information such as inventory levels, forecasts, sales promotion strategies, and marketing strategies reduces the uncertainty, explained in Transaction Cost (section 3.1.3), between supply partners and results in enhanced performance.

Cooper and Elram (in [30]) also argue that mutual sharing of risk and reward will yield competitive advantage, and that risk and reward sharing is important for long-term focus and cooperation among the supply chain members. In the same article, clearly supported by Network theory principles, they also emphasize that cooperation amongst the supply chain members is required for effective SCM.

With Figure 3-2, the above assertions, and Porter's *competitive advantage* in mind, one can claim that SCM's overall objective is to manage the *flows* connecting all parts of the supply chain, and that the ultimate goal of supply chain management is to maximize the chain's profit by; lower costs, increased customer value and satisfaction, and ultimately competitive advantage.

### **3.2.1 Supply Chain Risk Management**

In an increasingly competitive environment, supply chain managers must control and manage their risk [16]. This involves recognizing potential losses, understanding the probability of potential losses and their significance. Supply chain risk management attempts to reduce these risks to improve competitive performance by the use of internal resources linked up to the external operations in the supply chain. It is important to note that risk management is a continual process that calls for long term commitment from supply chain members. It includes gathering, communication and evaluation of information that can help create a suitable risk management strategy.

The supply chain can be divided into 5 subsystems that influence the outcome of the firm [39]; *supply, transportation, production, storage and demand*. These subsystems are again influenced by what is called 'second level factors'. The second level factors can be categorized as internal and external aspects. The internal are human, machine-related and infrastructural elements that can directly cause a disruption of any of the first level factors. The external aspects are related to customers and competitors. In addition to this there are the internal and external uncertainties that can disrupt the supply chain output by influencing the first- or second-level factors, called risk factors. The internal risk factors are possible for the firm to manage/mitigate while the external factors are out of the

firm's control. Figure 3-3 illustrates these factors, how they influence each other and the output of the firm.

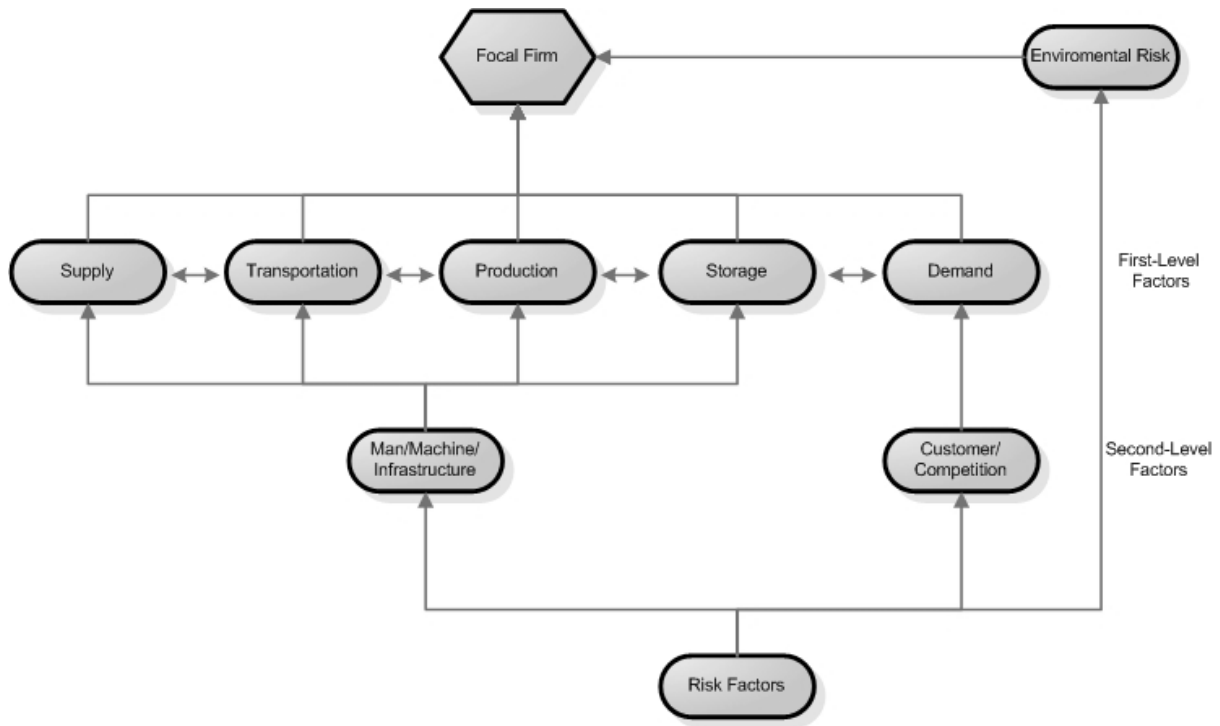

Figure 3-3 - Risk assessment of Supply Chain Performance

The risk factors include operational and technological factors in addition to social factors within the firm. The environmental factors can be categorized as natural disasters, economic framework and political influence.

To manage the risk-factors that are threatening the output of the firm the managers need to address several steps; describing the supply chain, a self assessment, evaluating the implications and identify actions. Here it is important to consider the Agency Theory described earlier. The risk element will vary in the supply chain, depending on whom being the agent or the principal in the relationships. It also depends on the relative importance of the supplier compared to other suppliers in the chain. Giunipero and Eltantawy [16] propose in their article 'Securing the Upstream Supply Chain': "*Major suppliers of high volume, value and/or critical items require more extensive risk management than those who supply fewer of less critical items*". This is in accordance

with the Resource-Based View (section 3.1.2). The appreciation of the importance of these elements is an essential determinant to the extent of how many resources should be subject to risk management. This can be seen in comparison with the transaction cost. Uncertainty, small number trading and asset specificity are important environmental factors that will decide the extent of risk management but also the amount of transaction cost that will be incurred. Another element to consider is that investments in risk management will reduce the likelihood of being exposed to supplier opportunism, looking back at the Principal-Agent Theory this will then justify behavior-based contracts.

Strategies for mitigating the risk element in the supply chain can be divided into four main categories [11]; options, reinforcement, diversification and warning systems. *Option* is a strategy where the firm has a backup for supply, production and/or transport in case of disruption. It is crucial that the option is separate from the regular supply chain so that it can be available if an adverse event occurs. *Reinforcement* increases the robustness of the system by for example keeping safety stock. This can make the system less vulnerable towards fluctuations and unwanted events. *Diversification* decreases the effects of an adverse event by decoupling the supply chain's elements, hence limiting the consequences of the disruption to only parts of the chain, for instance by using two suppliers for same product or two carriers for the transportation. *Warning systems* are implemented to increase the lead time detecting the first signals to when the disruption occurs. This way the firm has more time to prevent the adverse event from happening. The warning system does not make the supply chain more robust but only increases the awareness of the events approaching. Using financial instruments as safeguards can work as insurance but will not improve the performance or flexibility of the supply chain in any way and will therefore not be discussed. Deleris [11] suggest that industrial managers should take a global perspective on their supply chain by focusing on modifying the supply chain so that the overall risk can be reduced.

### **3.3 Management Concepts and Techniques**

This sub-section is dedicated to introduce concepts and available techniques much used in management of supply chains and businesses. Lean thinking and Vendor Managed Inventory (VMI) will be described and explained first. Then a commonly used concept with VMI; Third-Party Logistics will be introduced. Concurrent engineering will then be introduced followed by an introduction to two Supply Chain Management Tools.

#### **3.3.1 Lean Thinking**

Lean Thinking arose from Japanese manufacturing philosophy, Just-in-Time, and is known as the waste free environment [24]. The idea is that all activities should be value adding and if a step in the value chain does not add value it is regarded as waste and should be avoided and/or removed. Fundamental principles of Lean Thinking include [33]:

*Add nothing but value*

*Centre on the People who add value*

*Flow value from Demand*

*Optimize across Organizations*

*Add nothing but value* means that activities and resources absolutely necessary in order to create value are identified, and that everything else is considered *waste*. Waste can be divided into seven categories [33]:

*Overproduction*

*Defects/Nonconformities*

*Inventory*

*Waiting*

*Unnecessary processing*

*Transportation*

*Motion*

Waste is found by looking at a process and ask the questions; “Does this activity add value?” and “Is this a required activity?” If the answer to one of these questions is ‘no’, it can be regarded as waste and should be avoided according to Lean Thinking principles.

*Centre on the People who add value* imply first to improve the skills of developers through training, and secondly, to form teams of staff and managers to support developers.

*Flow value from Demand* mean that nothing is done before the downstream process requires it. Thus, production is not based on forecasts, but only on call offs, often referred to as a “pull based” production system [24]. Since the process only consists of activities that add value, it is important that the flow is as rapid as possible in order to avoid waste like inventory and waiting.

*Optimize across Organizations* imply that the focus of optimization has to be on the entire process and not by optimizing sub-processes. Optimizations of sub-processes are done at the expense of the overall optimization and waste is generated between activities/sub-processes. While if optimizing an entire process; an overall waste free process is within reach.

Despite Lean Thinking, every organization requires some activities that do not directly add value for the customer, also known as *Secondary activities* (or support activities) introduced by Porter [34]. The idea is that the number of these activities should be minimized. However, it is impossible to reduce the number of indirect activities (non-value adding) to zero due to the fact that some of these activities are necessary for the firm to function [24], i.e. administration. It is also important to note that the supply chain as a whole should be considered, as mentioned earlier, and therefore the organization needs to find a balance between the customer's and supplier's desires. This can be called the 'balancing act' and is illustrated in Figure 3-4 on the next page.

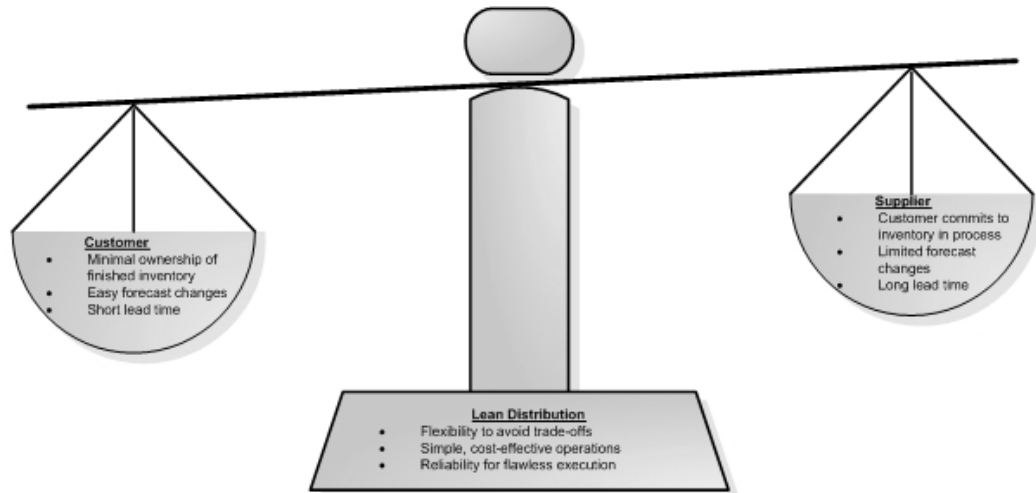

Figure 3-4 - The Balancing Act [Zylstra, 2006]

For the customer, flexibility to change on short notice is preferred for long lasting commitments that has no room for changes. On the other hand, the supplier wants certainty like long lead times and lasting plans with small possibilities for changes. The customer's and supplier's demand can not be fully aligned and therefore needs to be balanced. The negotiation position and strength decides which way the weight distribution shifts and was more thoroughly explained by the Power Structure in Network Theory.

### 3.3.2 Vendor Managed Inventory (VMI)

Lapide defines VMI as follows;

*Where a supplier manages its customer's inventories of its products, including setting inventory level targets, usually based on achieving a level of service specified by the customer. The inventories might be held on consignment (i.e., owned by the supplier) or owned by the customer.*

[Lapide, 2002, [26]]

Vendor Managed Inventory (VMI) is an increasingly used concept of the Supply Chain Management and was first implemented in industry in the late 1980s [40]. The basic idea is for the supplier to hold full responsibility for the customer's inventory. The supplier is responsible for the entire replenishment process; both the quantity and the timing of the shipments to the customer [3].

The supplier may also own the inventory (consignment stock) and will then be responsible for any waste, dead-stock, and costs associated with holding the inventory. Service levels are usually set by the customer and the supplier will in most cases replenish the inventory by means of max-min levels since the customer is entrusting the supplier to provide timely shipments and uphold a certain service level. Thus, mutual trust is a critical factor in VMI agreements [40].

Figure 3-5 points out the main difference between the traditional ordering process and VMI. Instead of solely dispatching an order as under traditional ordering process, the parties under a VMI program, use some sort of IT-solution (such as EDI (Electronic Data Interchange)) to communicate relevant information as forecasts, inventory levels, and take-outs [20].

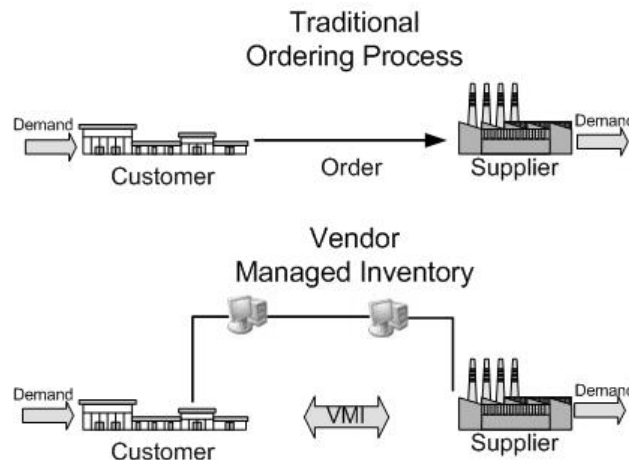

Figure 3-5 - Traditional Ordering Process vs. VMI

ODETTE International Limited ([www.odette.org](http://www.odette.org)) lists the following goals and expected benefits from a VMI agreement which also align with the principals of lean thinking:

- **Reduced non value-added activities and administration**
  - Reduce significant effort/cost for the supplier in following volatile demand (ad hoc rescheduling, trouble shooting, extra freight, overtime/idle time, etc.)
  - Reduced manual effort and responsibility for the customer (automated provision of updated planned consumption (gross demands) and inventory information)



- Reduced effort of handling and administration for both the customer and supplier
- Supplier has the opportunity to optimize production scheduling (lot sizes)
- **More secure and efficient Supply**
  - Supplier is responsible for guaranteeing customer supply/replenishment
  - Early warnings enable tracking and controlling of the whole process
  - Minimized ad hoc activities and related effort/cost
  - Robust with regard to interference
  - Prevention of stock-out and over-supply situations/smooth and secure supply with minimal inventory
  - Increased transparency, flexibility and synchronization of the 1:1 (b2b) relationship
- **Reduced Inventory and Transport Costs**
  - Improved inventory levels in the selected part of the supply network
  - Reduction of the total inventory (safety stock, etc.) in the supply chain
  - Reduction of transport and freight costs by optimization of transport frequency and lot sizes, and transport planning

*[Adopted from www.odette.org]*

Forecasts are shared under VMI, thus the supplier will experience higher visibility of customer demand. Hence, the supplier will experience less variance in customer orders and reduced delivery expenses by being better able to utilize space [32].

Betts [5], however, claims that VMI is being forced upon the supplier by a powerful customer to transfer most of their cost to the supplier. He also claims that there is no real advantage of VMI, and that it is just a way for the customer to transfer risks and costs involved with the inventory to the supplier. Both statements are in coherence with the assumptions of Power Structure explained in Network Theory. In some cases, if the VMI agreement is designed poorly, the consequences can be higher transportation costs for the

supplier in an attempt to satisfy the customer's service level requirements by shipping more frequently [10]. This is also an important factor in Transaction Cost Theory as earlier indicated.

Clark and Hammond [8] have conducted a study where they examine the effects of VMI in concurrence with EDI and EDI alone. The study shows that, in contrast to the previous assumptions, customers who implemented both VMI and EDI refer to an inventory turn-over five times greater than implementing EDI alone. However, upon further research, they acknowledge that most of the benefits of VMI could be achieved by information sharing alone. Moreover, Lee, So, and Tang [27] show that information sharing reduces the supplier's demand variance.

### **Implementing VMI**

There are several issues to keep in mind upon implementing VMI. For any type of agreement to be a success, performance measures must be agreed upon. They should involve both financial as well as non-financial measures. Non-financial measures such as POS-data (point-of-sale), accuracies for inventory levels, shipment, and lead times are just as important as financial measures including gross profit, cost savings, etc. [35]. Reflecting on the assumptions of Agency Theory, the selection of contract type will be crucial in managing a VMI-agreement.

Furthermore, when entering a strategic alliance like this, there will initially be problems which can only be solved by communication and collaboration. This communication is also essential for the entire alliance, both for communicating problems, but also data. EDI is a tool which can be useful for effectively sharing information throughout the supply chain. Appurtenant to this is the fashion of which data and information is shared. Handling proprietary, redundant, and different information formats are challenges in the concept of information sharing [35].

### 3.3.3 Third-Party Logistics and External Logistics Provider

Third-Party Logistics (3PL) is simply the use of an external provider to handle the company's logistics. The 3PL can handle the whole distribution function or parts of it. Modern 3PL agreements are more complex than in earlier years and are characterized by complex and long-term commitments and often handle more than just the transportation of products. Most of the large providers can manage many stages of the supply chain. Figure 3-6 shows a basic overview of a typical 3PL agreement.

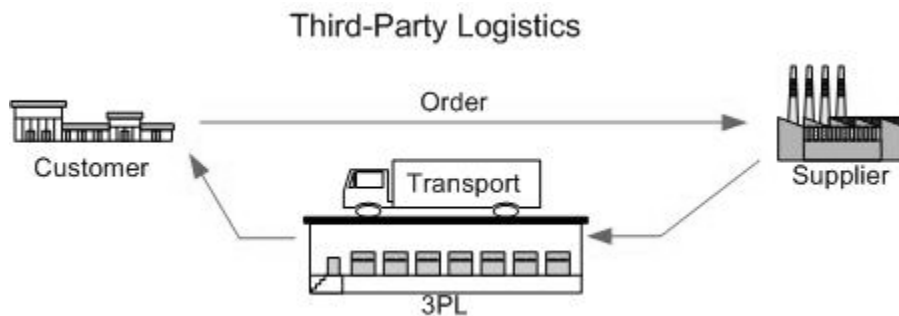

Figure 3-6 - Third-Party Logistics

Modern 3PLs are often referred to as ESPs (External Service Providers), and are often located in geographical proximity to the customer, or in close *customer orientation*. This is the first and foremost factor for a successful collaboration with an ESP and allows for *rapid replenishment*. The second critical characteristic is reliability, and flexibility is the third [35]. The overall reason for this outsourcing is for the supplier to concentrate on its core competences. This supports the principles of Resource-Based View discussed earlier. However, as explained in Transaction Cost, many companies outsource these services based on an attempt to reduce costs or because their customer demands it (see Power Structure in section 3.1.4).

An important advantage of such an agreement is *Technological Flexibility*. With the continuous need for technological improvements, many individual companies often do not have the time, resources, or for that matter, expertise to continually improve their technology. Harrington [19] points out that 3PLs can often meet these requirements in a

much quicker, more cost-effective way. As 3PLs are often large companies and deals with several other partners, benefits may also include economies of scale.

The principal disadvantage of a 3PL program is loss of control and higher transaction costs. Whilst the logistics part of the business is outsourced to experts, the control of the supply line down to the end customer may be partially or entirely lost. This can in turn reduce the customer attention of the company and increase risk. However, many 3PLs are working hard to address these concerns and efforts by painting company logos on the trucks, dressing their workers in the customers' uniforms and providing comprehensive reporting on each customer interaction [35]. Then again, if logistics is one of the firm's core competences, this outsourcing is not necessary and makes no sense to employ.

In addition to this, in recent years, Fourth-Party Logistics (4PL) has been coined to describe companies that manage a variety of logistics related services for clients using 3PLs. 4PLs are simply engaged to manage the logistics part (forwarding agent), and does not own any means of transportation units themselves.

### **3.3.4 Concurrent Engineering**

Concurrent Engineering, or Simultaneous Engineering, is a business strategy used to shorten the lead-times by dividing the development tasks. In Concurrent Engineering development tasks are divided into subtasks and performed in parallel, and in the end combined to produce an overall solution. Concurrent Engineering is a move away from the traditional based developing process, where activities are handed over from one department to another when finished, to a more team-based multidisciplinary approach. It also includes a consideration phase in every stage of the development process. This strategy focuses on the optimization and distribution of a firm's resources to ensure an effective and efficient product development process.

The team is meant to include every department involved; manufacturing, design, purchasing, finance, suppliers, and also customers in the design process. These departments are intended to share information and ideas and develop tasks in parallel

towards a common goal. This will lead to shorter development time, cost reductions and a better distribution of the firm's resources [24]. The biggest challenge is organization of the multidisciplinary team, to make it work, and be effective. This is more an organizational rather than a technical issue and key elements of the organization, especially boundaries, structures, relationships, and processes need to be reorganized.

### **3.3.5 Supply Chain Management Tools**

Controlling and monitoring an organization's material planning & logistic processes are necessary to meet increased customer expectations by continuous improvement throughout the supply chain. Continuous improvement is important to guarantee customer satisfaction and lower costs [24] and is based on the principals of lean thinking. In order to design and implement a well working supply chain, practitioners need to define the supply chain, understand and select the appropriate technologies, and then manage the implementation process. Different tools are provided to help companies design, implement and improve their supply chains. Two of the most recognized tools will here be described.

#### **3.3.5.1 Logistic Evaluation and Materials Management Operations Guideline**

ODETTE International ([www.odette.org](http://www.odette.org)) and AIAG's (Automotive Industry Action Group) ([www.aiag.org](http://www.aiag.org)) Materials Management Operations Guideline and Logistic Evaluation (MMOG/LE) is developed to support organizations build a Materials Planning & Logistic management system. The Materials Planning & Logistics is defined as;

*The process of planning, implementing and controlling the efficient flow and storage of goods, services and related information from point of origin to point of consumption for the purpose of confirming to customer requirements,*

[Odette/AIAG]

and the goal for every organization implementing MMOG/LE is a world class Materials Planning & Logistic management system. MMOG/LE is developed exclusively for the automotive industry, but is now also used by other industries reaching for the same goal (Odette/AIAG).

The MMOG/LE tool has several objectives;

- Produce a common standard for Materials Planning & Logistics that an organization can use in evaluation of both internal and external processes.
- Continuous improvement tool for the Materials Planning & Logistics processes.
- Benchmarking with internal and external partners, and identify best practices.
- Evaluate and improve supplier performance.

This tool can be used internally as a self assessment or by every partner in the supply chain as an examination tool.

### **Evaluation document and Methodology**

The MMOG/LE evaluation document is an excel workbook with 6 dynamic spread sheets; instructions, self assessment, scoring summary, gap analysis/action plan, glossary and maintenance request (desired changes on the actual evaluation document tool).

The Self assessment consists of 200 requirements posted as questions in 6 areas of Materials Planning & Logistics and each area is divided into subsections in an attempt to capture every aspect. It is necessary to answer all questions to achieve an overall evaluation of the processes. The questions are measured towards *best practice* and weighted after how they are prioritized in a continuous improvement process, but not necessarily their importance in the specific area. Each question has a weight factor from 1 to 3 points, where 3 points is the high risk factor (F3). This means that if the requirement here is not met there is a high risk for the process not meeting customer requirements and will lead to higher costs also in the short term. F2 requirements must be met in order to avoid that customer satisfaction and business performance are affected. F1 requirements must be met in order to maintain the organization's competitiveness.

The questions must be answered by ticking an 'X' in the checkbox if the requirement is met, or just left blank if the requirement is not met. The total score, found in the score summary sheet, is the basis of the grade the organization will receive. The grading system is presented in Table 3-3.

Grade	Score	Comment
A	<i>90 % &lt; Score</i> Maximum 5 'F2 requirements' not met All 'F3 requirements' met	Near "World Class" standard.
B	<i>75 % &lt; Score &lt; 90 %</i> 6-12 'F2 requirements' not met All 'F3 requirements' met	The organization has several areas that need improvement to meet customer satisfaction and an action plan should be in place and executed within 3 months
C	<i>Score &lt; 75 %</i> 13 or more 'F2 requirements' not met Any 'F3 requirements' not met	The organization has one or more critical aspects in any of the areas and need to work out an action plan rapidly to avoid serious and long lasting customer issues

**Table 3-3 - MMOG/LE Grading**

For every 'non-compliance' the requirement will automatically be shown in the "Gap analysis" sheet. Here the responsible can explain the deviation and make an action plan including the corrective actions, personnel responsible, time due, and cost to fulfill the requirement.

Before initializing the evaluation process a few aspects needs to be considered; assessment type, resources needed/available, and final preparation. It is first important to define if this is a self assessment or an external assessment of a customer or partner. It is important to allow enough time so that this evaluation can be as accurate as possible. Only one person should coordinate and supervise the MMOG/LE activities but it is important to include all people and departments involved in the different processes. Before the evaluation takes place it is important that the involved parties read the instructions, gain commitment to the evaluation process as a tool, and sketch a time frame.

After the preparation time, empirical data should be collected in order to investigate if requirements are met. It is important that all answers can be documented to verify data and support the answers. From the Gap analysis spread sheet it is important to develop an action plan and indicate the priorities for improvement. Enough resources should be included to ensure that all improvements can be implemented.

### 3.3.5.2 Supply-Chain Operations Reference-model

The Supply-Chain Operations Reference-model (SCOR-model) is a process reference model that has been developed and endorsed by the Supply-Chain Council ([www.supply-chain.org](http://www.supply-chain.org)) as a cross-industry standard diagnostic tool for supply-chain management. SCOR enables users to address, improve, and communicate supply chain management practices within and between all parties.

SCOR is a process reference model for supply-chain management, spanning from the supplier's supplier to the customer's customer as schematically expressed in Figure 3-7.

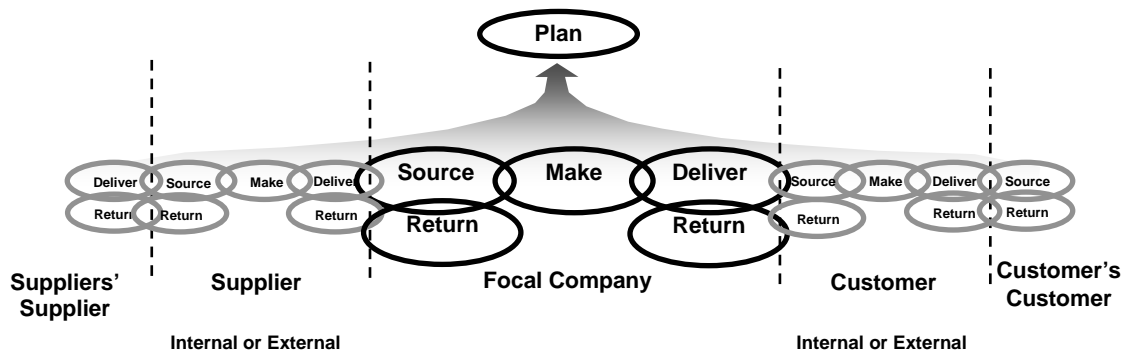

Figure 3-7 - SCOR-model [[www.supply-chain.org](http://www.supply-chain.org)]

The SCOR-model has been developed to describe the business activities associated with all phases of satisfying a customer's demand. By describing supply chains using process building blocks as in Figure 3-8, the Model can be used to describe supply chains that are very simple or very complex using a common set of definitions. As a result, disparate industries can be linked to describe the depth and breadth of virtually any supply chain.



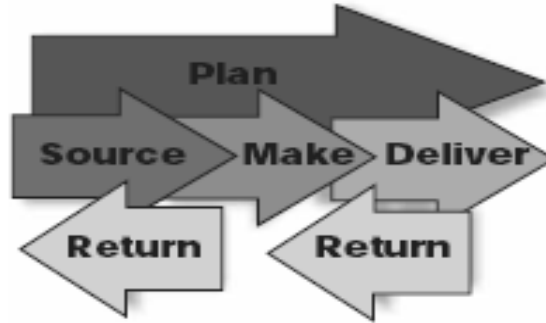

Figure 3-8 - SCOR-model [www.supply-chain.org]

The SCOR model is divided into 5 main management processes (see Figure 3-8): Plan, Source, Make, Deliver, and Return.

- The process of *Planning* is to balance resources with requirements and establish plans for the whole supply chain. It includes management of business rules, supply chain performance, data collection, inventory, capital assets, and transportation. It also aligns the supply chain plan with the financial plan.
- The *Source* process is whatever procurement activities that are required. It includes scheduling deliveries, receiving, identifying and selecting supply sources, assessing supplier performance, supplier network, and managing inventory (etc.).
- The *Make* process is the production management. It includes production activities, testing, packaging, equipment and facilities, and inter-firm transportation (etc.).
- Managing orders, processing customer inquiries and quotes to routing shipments and selecting carriers is embedded in the *Deliver* process. It also includes warehouse management, receive and verify product at the customer site and invoicing the customer. Furthermore, managing transportation and collecting performance (etc.) data is also a part of the *Deliver* process.
- The *Return* process handles the return from all product stages from *Source* – identify product condition, product return-shipment, repair and excess product returns (etc.).

Further, the SCOR-model can be ‘drilled down’ into several levels. These drill downs of processes are schematically described in Figure 3-9. Each process has its own sub-process which then has its sub-process, and so forth.

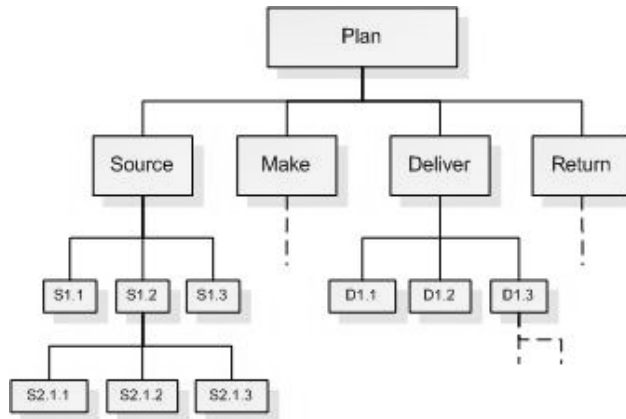

Figure 3-9 - SCOR – ‘Drill down’

In order to better illustrate the philosophy behind the SCOR model, an example will now be provided.

Taking basis in Figure 3-9 above, the example drills down *Source*, finding that it consist of 5 sub-processes (at level 2) as exemplified in Figure 3-10.

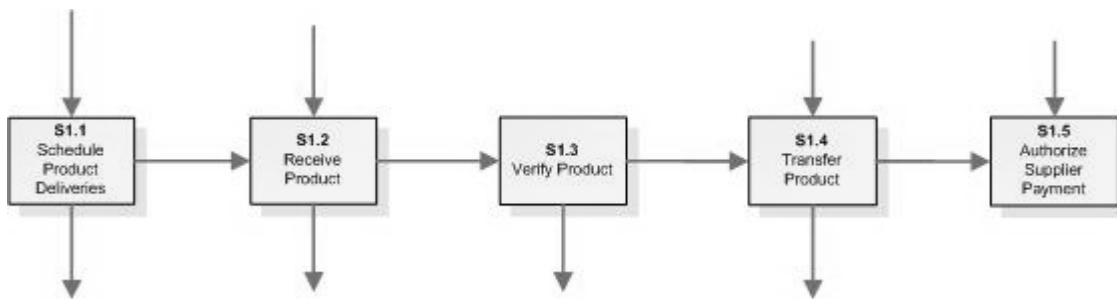

Figure 3-10 - Basic Logic Flow, inputs & outputs [www.supply-chain.org]

Further investigation into S1.1 (Schedule Product Deliveries) shows that the process can be further drilled down as Table 3-4 on the succeeding page illustrates (at level 3).

Performance Measures	Metric
Reliability	Percentage of Schedules Generated within Supplier's Lead Time
	Percentage of Schedules Changed within Supplier's Lead Time
Responsiveness	Schedule Product Deliveries Cycle Time
Flexibility	None Identified
Cost	Schedule Deliveries Cost as a percentage of Product Acquisitions Costs
Assets	Return on Supply Chain Assets
Best Practices	Features
Utilize EDI transactions to reduce cycle time and cost	EDI interface
Mechanical (Kanban) pull signals are used to notify suppliers of the need to deliver product	Electronic Kanban Support
Consignment agreements are used to reduce assets and cycle time	Consignment inventory management
Advanced ship notices allow for tight synchronization between SOURCE and MAKE processes	Blanket order support with scheduling interfaces to external supplier systems
Vendor Managed Inventory	See VMI (section XX)

**Table 3-4 - Drill down [www.supply-chain.org]**

The upper part of the table lists different measures that has to be taken into account when evaluating the process of 'Scheduling Product Deliveries' and by what metrics they are measured. The lower part of the table lists what is necessary to achieve or/and maintain a best practice within the respective field/process. Other processes have potential for further drill downs and can be elaborated in greater detail and in more than three levels.

### **3.4 Information systems**

As the competition tightens, frequent and effective information sharing is becoming increasingly more important. In recent years companies have been forced to find new ways of sharing information in order to maintain its competitiveness (Cooper et al. in [30]). In this sub-section EDI and SAP will be introduced.

### 3.4.1 EDI

EDI (Electronic Data Interchange) is a tool for sending and receiving trade-related information, such as purchase orders, invoices, inventory levels etc. It is a *computer-to-computer* exchange of structured, pre-defined information from one computer application to another by electronic means. EDI electronically transmits data and replaces paper documents, minimizing human interaction – reducing the probability of human failure – as illustrated with Figure 3-11.



Figure 3-11 - Traditional Information Sharing Versus EDI

EDI saves unnecessary re-capture of data<sup>1</sup>. This leads to faster transfer of data, far fewer errors, less time wasted on exception-handling, and hence a more stream-lined business process [9]. Benefits can be achieved in such areas as inventory management, transport and distribution, administration and cash management. EDI offers the prospect of easy and cheap communication of structured information throughout any supply chain.

EDI can be used to automate existing processes. In addition, the opportunity can be taken to rationalize procedures, and thereby reduce costs, and improve the speed and quality of services. Because EDI necessarily involves business partners, it can be used as a catalyst for gaining efficiencies across organizational boundaries [9].

---

<sup>1</sup> Example of re-capturing of data: receiving Fax, then scanning it, then e-mailing it, and printing it, as exemplified in the upper part of Figure 3-11.

### 3.4.2 SAP and ERP systems

Enterprise Resource Planning (ERP) is a common database system that integrates all the functional business areas in an organization including; Financial Control, Material Planning and Control, Sales and Marketing Coordination, Engineering Activities; and Quality Assurance, as illustrated in Figure 3-12 The ERP system gathers data utilized by the different areas to obtain information and update the progress on the specific activities they perform. SAP's R/3 system is a ERP software and is now the market leader in this segment [25]. There are several providers of ERP software, but since HARA is employing SAP, it will be the focus of this section.

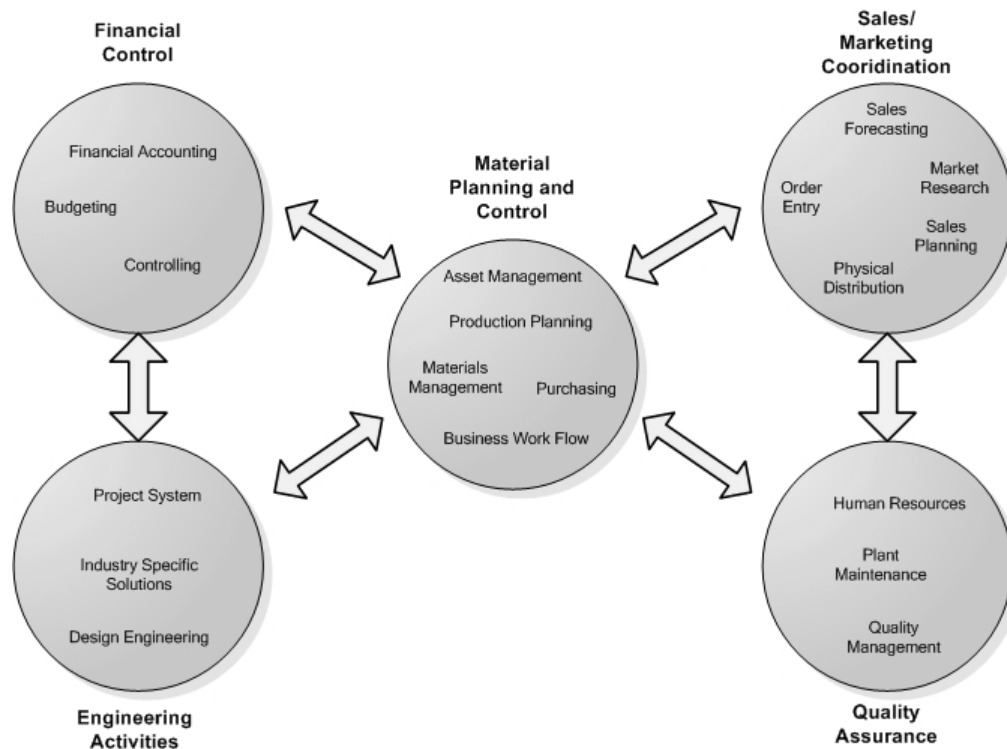

Figure 3-12 - Business areas and activities

SAP (Systems, Applications, and Products in Data Processing) was formed by five former IBM employees in 1972 and is now the world's fourth-largest independent software supplier in the world. R/3 is their leading software package for the whole range of business applications with its own client-server solution. Today 8 out of the 10 largest US companies uses SAP software ([www.sap.com](http://www.sap.com)).

The SAP R/3 package includes:

Asset Management, Controlling, Financial Accounting, Human Resources, Industry Specific Solutions, Plant Maintenance, Production Planning, Project System, Quality Management, Sales and Distribution, Materials Management, and Business Work Flow.

Implementing ERP software systems intend to [23]:

1. Enhance productivity, flexibility and customer responsiveness
2. Enable new business and growth strategies
3. Eliminate costs and inefficiencies
4. Expand the knowledge of key business data
5. Extend the business using the Internet

It is important to notice that ERP and the SAP software systems are complex solutions to a complex problem and need to be totally integrated in the organization in order to achieve these competitive advantages. Additional supply chain management software can extend the ERP system to include the company's suppliers and customers. The SCOR-model is also included in the SAP R/3 package.

## **4 The Studied Case**

This section of the Thesis is dedicated to present the studied case. First, the companies involved will be introduced, followed by a brief introduction of the supply chain solution currently employed in the project, this in order for the reader to be familiarized with the different actors, the relations and why they are chosen.

### **4.1 Hydro Aluminium Structures Raufoss**

Hydro Aluminium Structures Raufoss (HARA) is a part of the Hydro's aluminum business. They specialize in making aluminum components for the automotive industry. Situated in mid-Norway their location is a disadvantage for the logistic and transport competitiveness compared to other similar suppliers located in closer proximity to their customers, which often are situated in the continental Europe. However, HARA possess great expertise and experience in the field at Raufoss and delivers today more aluminum bumper beams to car manufacturers (OEM) than any other company in the world. Aluminum being a light weight metal is greatly desired in the car industry as they seek to continuously reduce the weight of cars.

### **4.2 Audi**

Audi is a world leading German car manufacturer also know as a Original Equipment Manufacturer (OEM). Audi is a division of the Volkswagen (VW) Group, owning plants around the world with a plant in Bratislava, Slovakia set to produce the Audi Q7 rendered in Figure 4-1. This Thesis will, however, consider Audi as the customer of HARA's bumpers, even tough the car assembly is performed on VW's production lines, in order to achieve consistency and to avoid misunderstandings. Apart from producing Audi Q7, the plant in Bratislava also produces Volkswagen Touareg and Porsche Cayenne.



Figure 4-1 - Audi Q7 [www.Audi.com]

### **4.3 Kirchhoff**

Kirchhoff is a German international company providing many car manufacturers with components. They are HARA's supplier in this case, whilst competitors in some areas. Kirchhoff is manufacturing steel components and has a very low cost operation in Poland. Since the discovery of aluminum, steel has been considered too heavy by the car manufacturers in their pursuit for leaner cars. Thus, HARA has been a leading provider of bumpers and other parts to the car industry. Recently the processing of steel has evolved and resulted in both stronger and lighter steel components. Hence, Kirchhoff is continuously advancing in the car industry as a light, low cost, provider of various steel components.

### **4.4 Schnellecke**

Situated in close proximity to the Audi plant, Schnellecke possesses one of the most crucial advantages of the car industry. Not longer than 20 minutes away from the Audi plant, Schnellecke is an obvious partner of Audi. In addition, Schnellecke is a spin-off from Audi and thus has close relations with Audi and possesses the right know-how. Schnellecke handles the supply of numerous parts to Audi and some preassembly, also called Value Adding Logistics (VAL) in addition to traditional logistic services.



#### **4.5 Hydro Slovakia**

Hydro Slovakia was established to cope with the Value Added Tax (VAT) as a result of the VAL Schnellecke provides for HARA in Slovakia. As HARA not only sells the bumpers to Audi in Slovakia but also assembles them (through Schnellecke) before they are sold, VAT must be addressed.

When Schnellecke assembles bumpers and mounting brackets, they perform a value adding process. When value adding work is performed, companies are obliged to pay tax on that work, and since HARA still owns the stock at Schnellecke they must take responsibility for it.

Hydro Slovakia was then established as a Slovakian company purchasing the bumpers from HARA. Thus HARA dodge the VAT they must pay for the value adding work Schnellecke performs. However, Hydro Slovakia is then obliged to pay VAT for the same work but, being a Slovakian company, they will get the VAT returned.

Hydro Slovakia is paying both Schnellecke and Kirchoff before profits are transferred back to HARA.

#### **4.6 Multisped**

Multisped AS is a forwarding agent, owned by; Toten Transport A/L, LRN Transport AS, and Schenker Norge AS, with Toten Transport as the majority shareholder with 60% of the shares. Established in 2002, Multisped recognizes themselves as a 4PL provider (fourth-party logistics provider) as they utilize one or more of their parent companies with main focus on inbound and outbound logistics from 'Raufoss Industripark'.

#### **4.7 Organizational Structure of the studied case**

Hydro Aluminium Structures Raufoss (HARA) has concluded an agreement with Audi to supply them with aluminum bumpers for their Audi Q7. In their pursuit to satisfy Audi's requirements, HARA have decided to engage a supplier of steel mounting brackets for the bumpers. Among the main reasons for the decision is that the cost of steal is lower than that of aluminum, and the transportation costs would be less. Assembling bumpers

and brackets at Raufoss would increase the transportation costs as it would increase the “dead weight” or air inside the containers due to the efficiency of packaging. Kirchhoff was chosen as supplier of these brackets due to lowest price offered. HARA was forced by Audi to use a 3PL provider in Schnellecke, Bratislava. Schnellecke is a 3PL for Audi for several components with a long relationship and well working routines. Kirchhoff delivers the brackets to Schnellecke where brackets and bumpers are assembled. HARA is the owner of the brackets and bumpers until delivered to Audi. Multisped arranges the transportation between Raufoss and Bratislava (Schnellecke) as they do for all of HARA’s transportation (see Figure 4-2).



Figure 4-2 – The Supply Chain’s Structure

## **5 Empirical Evidence**

This section will provide empirical evidence for the case analysis. The section will start with the introduction to the contracts HARA has with its suppliers and customers in the 'Pikes Peak' project. It will then describe and illustrate the flow of material, information and money in the supply chain. The last part of this section will explain the development phase of a general project at HARA with key focus on the logistic department's involvement.

### **5.1 Contracts**

There exist two types of contract agreements – overall agreement and logistic agreement. The logistic agreement contains the agreed behavior in order to get a well working supply chain. In the 'Pikes Peak' case there exist logistic agreements between HARA and Schnellecke, Kirchhoff and Audi. In addition to this, HARA has a business contract with Multisped for all their deliveries. The contracts' main contents are summarized in Table 5-1 on the next page.

<i>HARA's contracts</i>	<b>Schnellecke</b>	<b>Kirchoff</b>	<b>Multisped</b>	<b>OEM (Principal)</b>
<b>Length of contract</b>	Car model life time	Car model life time	3 years	Car model life time
<b>Responsibilities</b>	Assembly, delivery, storing	Delivery of brackets. Production and transport	Transport Raufoss - Bratislava	Self-billing
<b>Quality measure</b>	Assembled bumpers checked towards template	Quality Check at Schnellecke.	On time delivery	
<b>Prices</b>	Price pr bumper and square meters	Price pr bracket	Price meter load and destination	Price pr delivered bumper. Price varies.
<b>Information flow</b>	Email	Email	Email/Mail	EDI
<b>Outcome measure</b>	Quantity received and delivered	Quantity delivered	Shipment delivered	Quantity received and price calculated
<b>Type of Contract</b>	Outcome-based	Outcome-based	Outcome-based	Outcome-based

**Table 5-1 - Contract summary**

As illustrated in Table 5-1, all contracts in this supply chain case *Outcome based* contracts. This means that all parties in the chain get paid for the product and service they deliver. It is important to note that the length of the contracts, except the Multisped relation, lasts for the entire car model life time but can be terminated earlier. All prices are fixed apart from the assembled bumper delivered to Audi. This will fluctuate with the price of aluminum. The communication modes established in the contracts are regular mail, e-mail and EDI communication dependant on the agent's routines and resources. In the discussion section each of the contracts will be evaluated closer with respect to Principal-Agent theory.

## 5.2 Supply Chain Flows

The flow of material, information, and money in the supply chain were briefly introduced in section 4.7 but will be graphically described in this section of the paper.

Figure 5-1 shows an overview of the flow of material in the supply chain. HARA has hired a 3PL (Schnellecke, Slovakia) to handle the storage and assembly of the bumpers. Kirchoff, the polish supplier, has been hired to provide mounting brackets for the bumpers.

The supply chain also includes a sub-division of Audi that handles spare parts located in Ingolstadt (Germany). The transportation from HARA to Schnellecke is handled by Multisped. The transportation from Kirchoff to Schnellecke is handled by Kirchoff, while the transportation from Schnellecke to Audi is handled by Schnellecke.

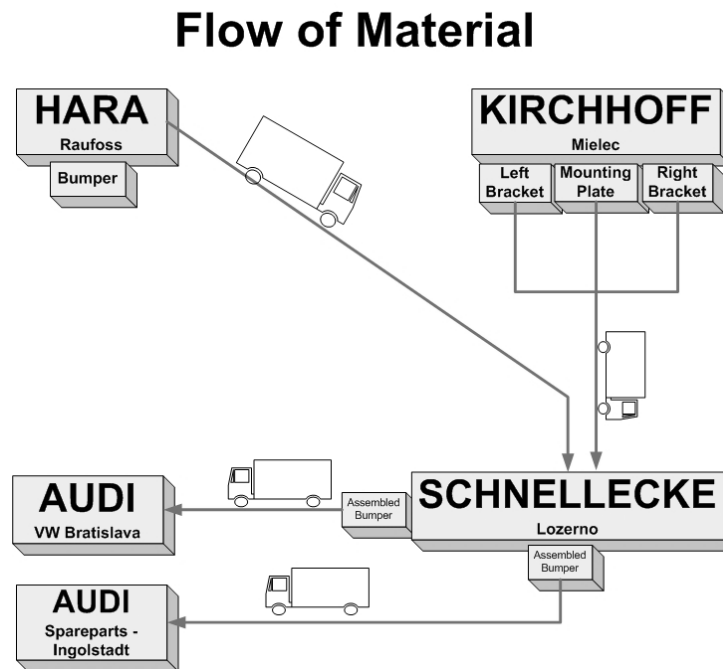

Figure 5-1 - Flow of Material

Figure 5-2 present an overview of the flow of information. The origin of information starts at the Audi plant in Bratislava. They provide HARA with their sales prognosis on a weekly basis. The forecast estimates the demand for up to 6 months in advance but is also supported by a more accurate short-term forecast over the next two weeks.

The prognosis is transferred to HARA by EDI which is then registered into HARA's SAP-software. The same forecast is also sent to Kirchoff from HARA, by e-mail. Together with the daily inventory and transaction reports from Schnellecke, HARA compose their Master Production Schedule (MPS). HARA produce and transport bumpers based on this information. Kirchoff, however, will only use this forecast as a guideline for their production. They receive the real orders from Schnellecke by call offs. Daily delivery notifications are sent from the Audi plant to Schnellecke each morning containing the demand for bumpers that particular day and trigger the assembly of bumpers. Call offs are sent approximately an hour in advance containing the *exact* quantity which triggers the loading and shipment of the bumpers. At times when spare bumpers are needed at Ingolstadt, the warehouse orders replenishment through the office in Wolfsburg. The orders are sent to HARA which notifies that there will be additional bumpers delivered to Schnellecke and that these are to be assembled and delivered to Ingolstadt.

## Flow of Information

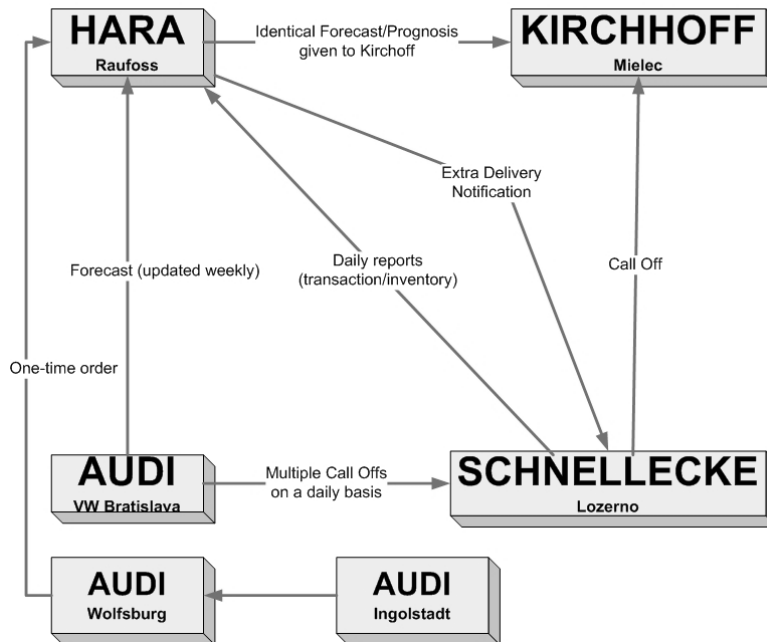

Figure 5-2 - Flow of Information

Figure 5-3 on the next page illustrates the flow of money in the supply chain. This includes a subdivision (see section 4.5) of HARA located in Slovakia.

## Flow of money

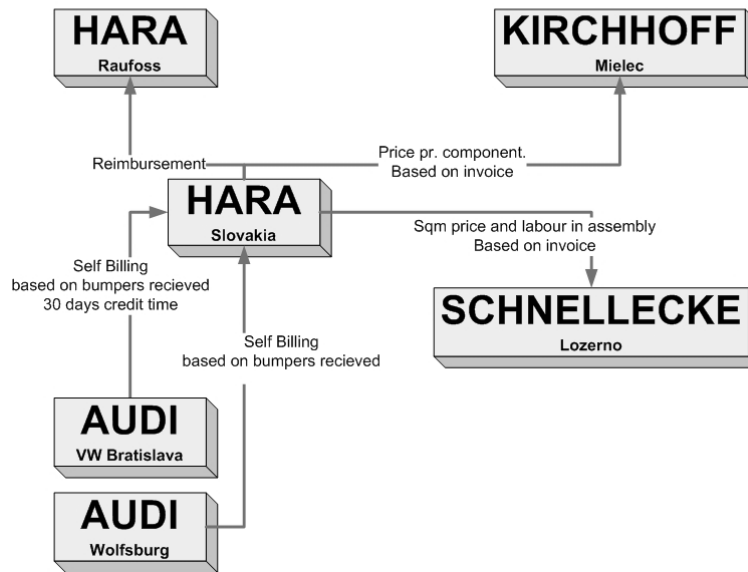

Figure 5-3 - Flow of Money

Hydro Slovakia handles all income and payment in this supply chain for HARA. Payments come from the Audi plant in Bratislava and Audi Wolfsburg for spare parts. Payment is done to Kirchoff for brackets and Schnellecke for their storage and assembly.

### 5.3 Project development phase

When a car manufacturer decides to make a new car model the need for a new bumper arise. HARA's sales persons are in continuous contact with the different car manufacturers and are the first ones to be involved in this process. When the OEM's requirements are mapped, HARA nominates a project manager. The project manager's responsibilities are to gather a project team, calculate a product offer and supervise the project until the new bumpers are in series production. This includes a detailed project schedule and weekly meetings. Hydro's automotive group has implemented a project process guide that all new projects shall follow. This guide consists of four core processes, where core 1 is on an aggregate business level, for example discussion about moving parts of production overseas, while core 2-4 are more project specific, i.e. a new

product's development process. The core processes and decision stages is illustrated in Figure 5-4.

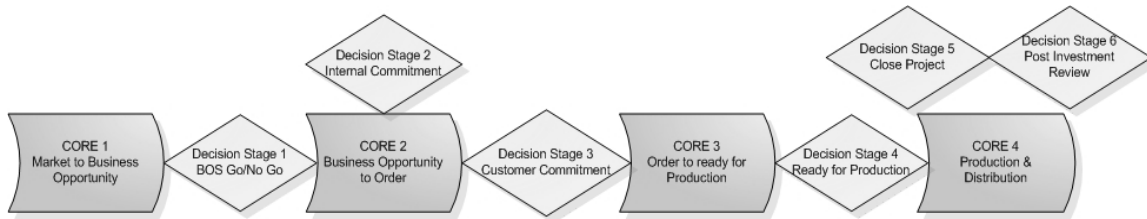

**Figure 5-4 - Core Processes**

A project team is set up before the project goes into core 2 and is based on the principles of concurrent engineering, where members of all involved departments are included and tasks are performed in parallel. Below in, Figure 5-5, the 'Pikes Peak' organization is illustrated.

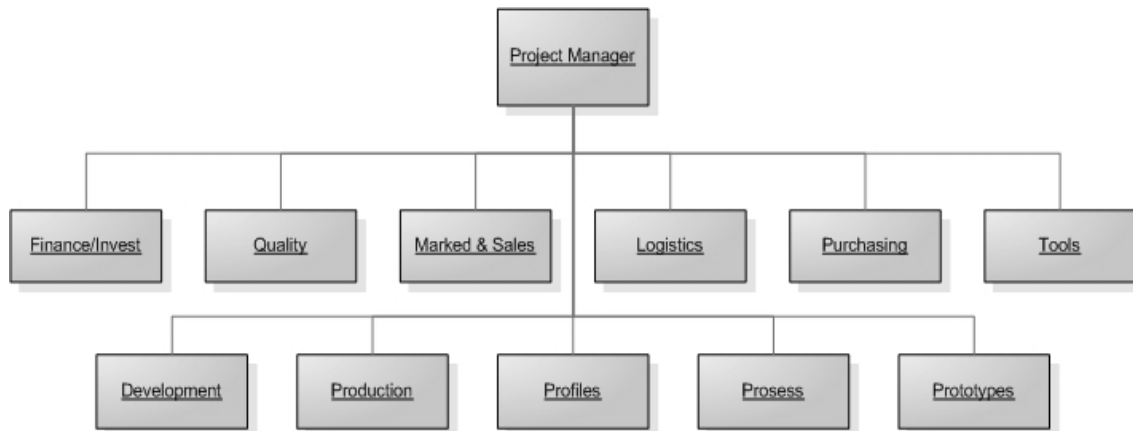

**Figure 5-5 - Project Team Organization**

The core process describes each department's contribution illustrated in process diagrams and descriptions, and is meant to follow lean manufacturing principles - waste free environment and value adding activities. This way each department knows their expected contribution and can act accordingly. The logistic department has extracted from this a Logistic Project Status Report (LPSR) that works as a project plan and checklist for their respective contribution. In the LPSR the logistic department's status in the specific project can be controlled and an action plan generated. The LPSR is depicted in Figure 5-6.



Hydro Aluminium Automotive							LOGISTIC PROJECT STATUS REPORT (LPSR)		
Status date: Customer: Car: Product: Logistic Concept: Project leader: Logistic Project Coordinator (LPC): Local SC-Manager involved (LSCM): Scheduled PPAP: Scheduled SOP:							OK	OBS	Danger
Phase	Activity	Sub.	Responsible	Schedule d date	Completed date	Comments/ consequence			
Core 1 and 2	Collecte market/customer requirements	1	SCC						
	Check capacity situation	2	Head of Logistics						
	Collect and define Logistic Datas	3	SCC						
	Estimate Logistic costs	4	SCC						
	Update Logistic costs	5	SCC						
Core 3	Define Logistic Project Team	6	SCC						
	Establish link to Customer Internet	7	SCC						
	Value Stream Mapping (VSM)	8	SCC						
	Agree on final flow concept	9	SCC						
	Confirm packaging type,labelling and	10	SCC						
	Confirm transportsolution	11	SCC						
	Confirm solution for VAT	12	SCC						
	Confirm 3.Party logistic solution	13	SCC						
	Test and approve packaging solution	14	SCC						
	Logistic cost confirmation-revised	15	SCC						
Core 3	Establish Logistic Agreements with customers/suppliers	16	SCC						
	Confirm Information flow (EDI and paper documents and labelling)	17	SCC						
	Data in put in ERP	18	SCC						
	Packaging availability	19	SCC						
	Transport agreements/contracts	20	SCC						
	3.Party agreements/contracts	21	SCC						
	Ramp-up planning	22	SCC/Project leader						
	Handover Log concept and costs	23	SCC						
Core 4	Evaluation/Feedback from plants	24	Plant Manager						

Figure 5-6 - Logistic Project Status Report

In the LPSR each main logistic task for the core processes can be seen and their progress plotted accordingly. The status is indicated with a green (OK), yellow (OBS) or a red light (Danger) and scheduled time is determined.

When each core process phase comes to an end, with inputs from each department included, the project goes into a decision stage. This is an evaluation concerning whether to continue the project or not. HARA's projects life cycle consists of 6 decision stages as

illustrated earlier in Figure 5-4. For each decision threshold, more and more resources are involved in the project.

## **6 Discussion**

This section is devoted to provide discussion around the 'Pikes Peak' project. It will start off by describing the structure and performance of the supply chain. Then the development of the project will be discussed followed by an assessment of the contracts and the supply chain risk exposure.

### **6.1 Project Structure and Performance**

This section of the Thesis intends to discuss the structure and performance of the supply chain. First, the Project Process Map will be reviewed followed by suggestions on improvements concerning the different interactions between HARA and its partners. The section will conclude with a summary of the improvements suggestions with appurtenant discussion.

#### **6.1.1 Project Process Map**

To achieve a better business understanding, theory states that developing a Business Process Map (BPM) should be the first step to get an overview picture of the different processes that constitutes the supply chain (see section 2). This will generate a process documentation which can be used as an illustration of the current state, basis for improvement investigation and increase task programmability. This section is dedicated to provide such a process map and explain the relations throughout the supply chain.

Using numerous interviews with people responsible for material, information, and financial transactions, a BPM is developed of the Supply Chain solution in 'Pikes Peak' and is illustrated in Figure 6-1. During these interviews the BPM has been continuously improved and altered to finally match the current state of the supply chain solution. It has been coined 'Project Process Map' (PPM) to better define its nature.

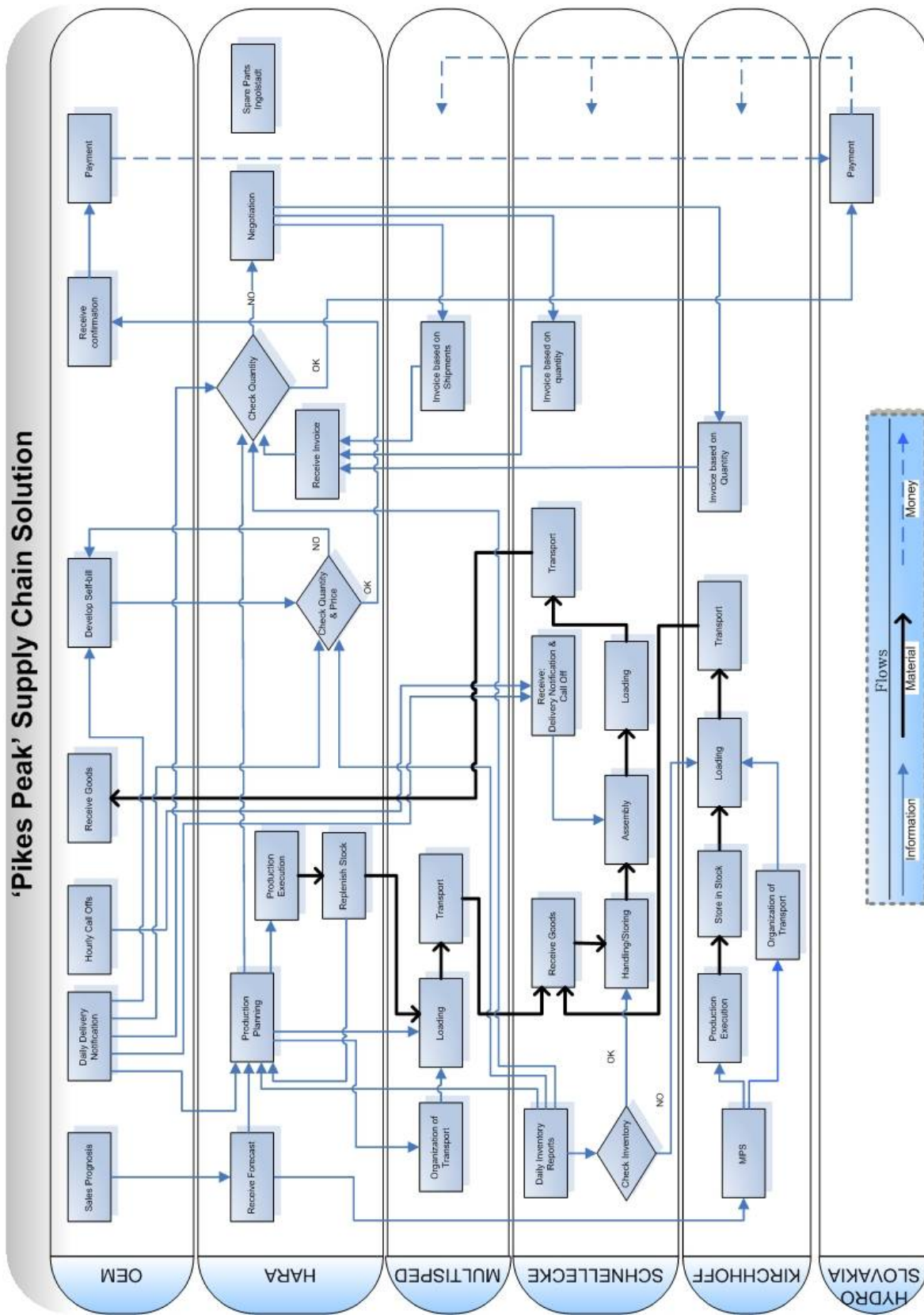

Figure 6-1 - Project Process Map

The different processes performed by each party are illustrated by square boxes and every check or decision is represented by a tilted square box. Information flows are represented by blue arrows, material flows by black arrows, and financial flows are represented by dotted blue arrows.

The Project Process Map in Figure 6-1 on the preceding page is an overview of all processes constituting the Supply Chain Management; thus each process illustrated in the map are supported by other, more profound, processes.

The authors have decided to examine the parts of the PPM that HARA are responsible for due to the complexity, the focus of the project, and available information. These examined parts, or 'drill downs', of the PPM will be described in greater detail in the following section.

### **6.1.2 Processes**

The first process that HARA is responsible for is receiving the forecast sent from Audi (OEM) each week and is rendered in Figure 6-2 on the next page.

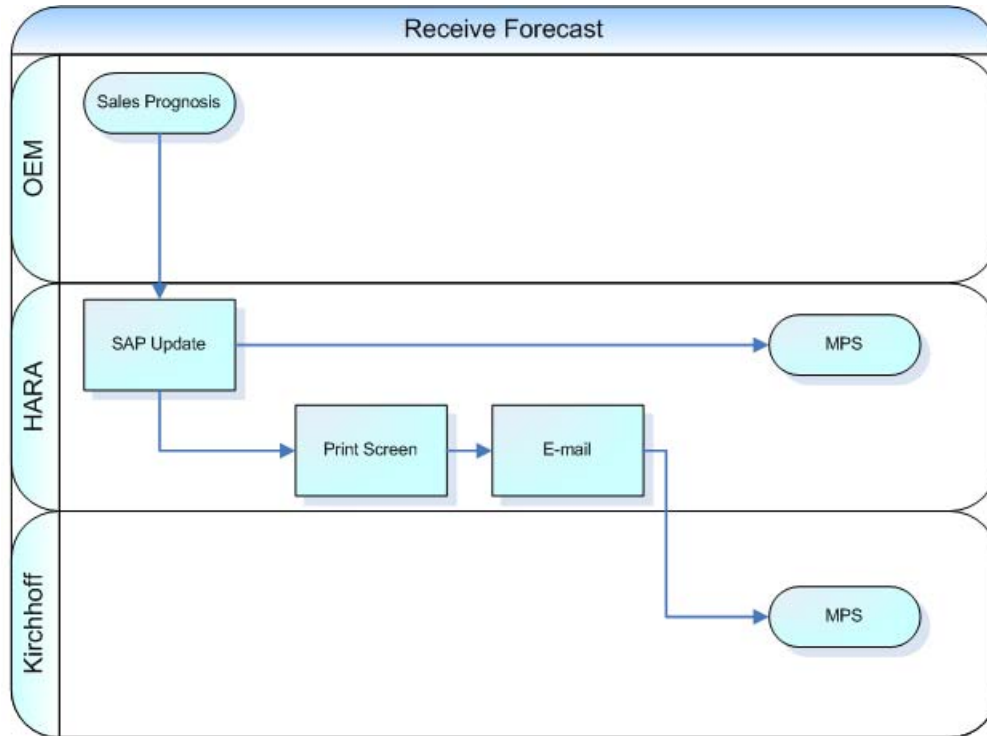

**Figure 6-2 - Receive Forecast**

The weekly forecast is received from Audi via EDI which is then updated in SAP. SAP uses these figures to develop a Master Production Schedule (MPS). The logistics department is responsible for taking a Screen Shot of this forecast and e-mailing it to Kirchhoff which in turn uses these figures to develop their own MPS.

The next process is Production Planning and is illustrated in Figure 6-3 below.

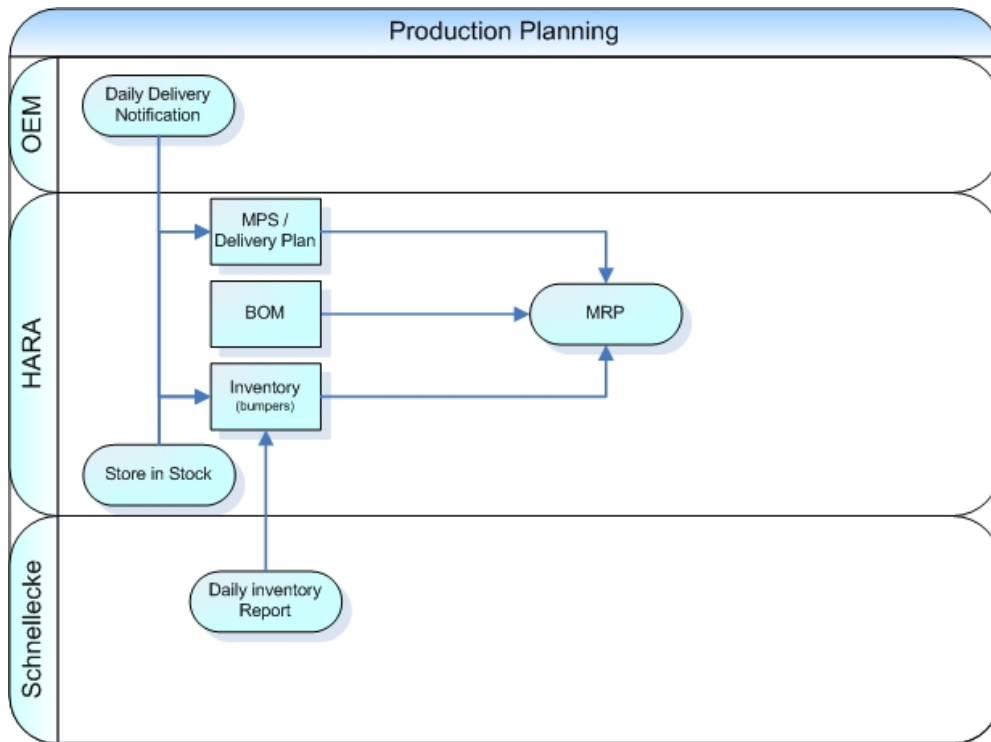

**Figure 6-3 - Production Plan**

For the process of planning the production of bumpers, HARA needs the daily delivery notifications from Audi, their own inventory level, and the inventory level at Schnellecke. The daily delivery notifications and the inventory levels are used to develop a MPS and to monitor their external stock of bumpers at Schnellecke. The inventory report from Schnellecke is also a control parameter but is mainly used to control the amount of parts bought and received from Kirchhoff. The MPS, BOM, and the inventory reports are used by SAP to create a MRP by traditional means.

Drilling down into the MRP the process illustrated below, in Figure 6-4, is revealed.

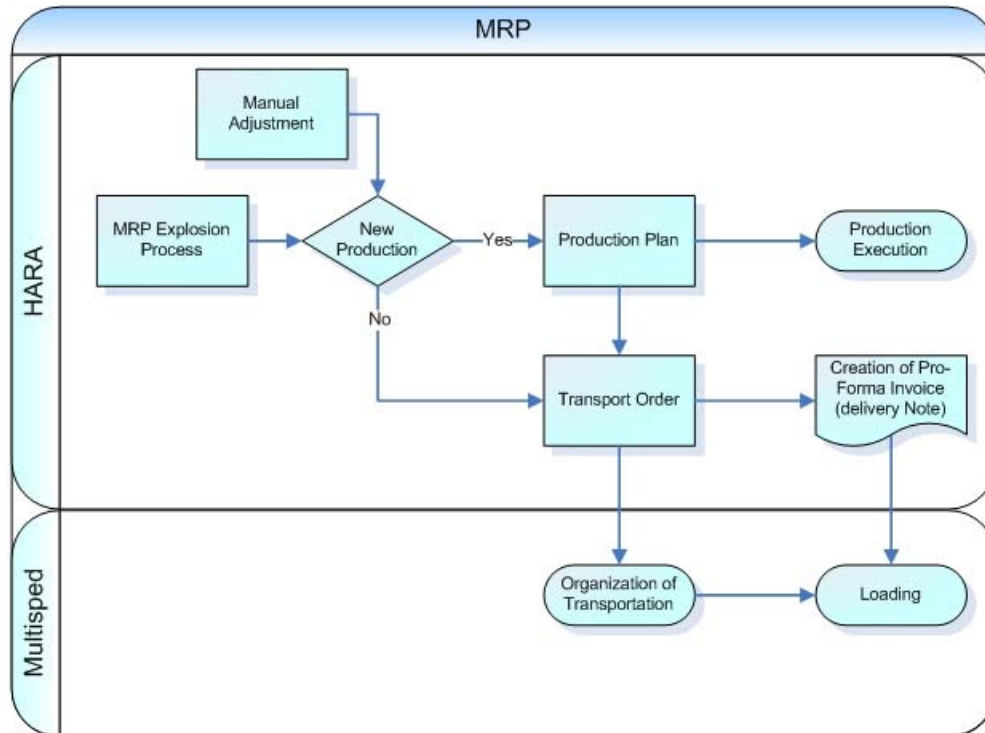

Figure 6-4 - Material Resource Plan

While Figure 6-3 represented the process leading to the MRP, Figure 6-4 represents the insides of the MRP process. First, the MRP Explosion process is performed by traditional means. Then, the MRP calculates whether or not a new production execution is necessary in order to maintain the desired service level. It is, however, manually adjusted as a consequence of different reporting times at Schnellecke and Audi, aided by the daily inventory reports from Schnellecke. Either way, as a final result, it will create a transport order and a pro-forma invoice. The transport order is sent to Multisped, and they organize transport. While they are loading their containers they will receive the pro-forma invoice necessary for customs clearance.



After a production execution, bumpers will be stored in the inventory at HARA represented in Figure 6-5.

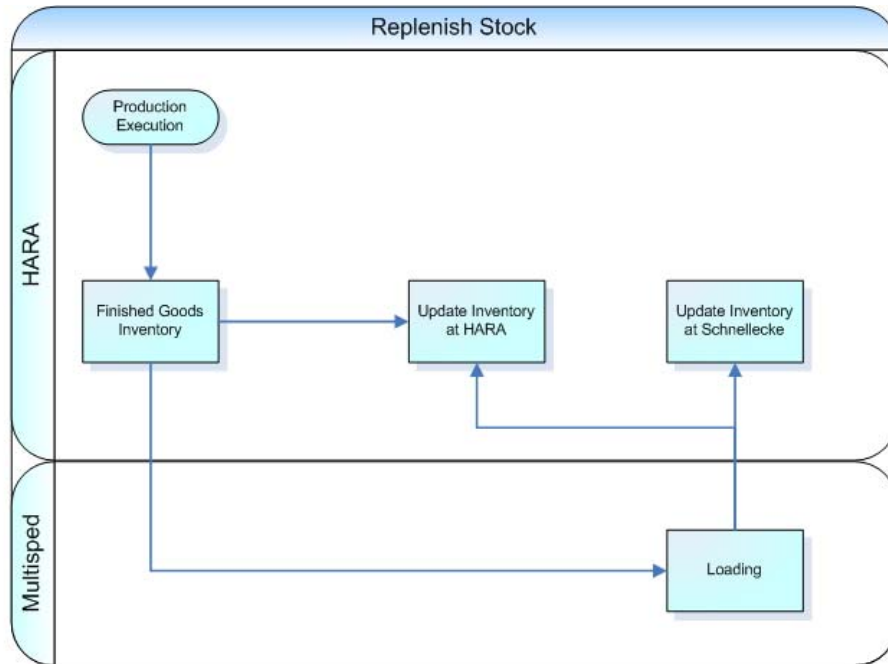

Figure 6-5 - Replenish Stock

The most vital part of this process is to update the inventory levels in SAP. After production and handling it is crucial to notify SAP of the new bumpers in stock. It is also equally crucial to notify SAP whenever Multisped loads bumpers for transport. Whenever an 'outtake' is reported, SAP is updated. SAP regards the outtake as an input in the inventory at Schnellecke. This way SAP should always hold the levels at both HARA and Schnellecke.

The next process in the interface between HARA and its partners is the verification of invoices and self-bills. The first process, towards Audi, is checking that the quantity of fully assembled bumpers and the price paid are correct. This process is rendered in Figure 6-6.

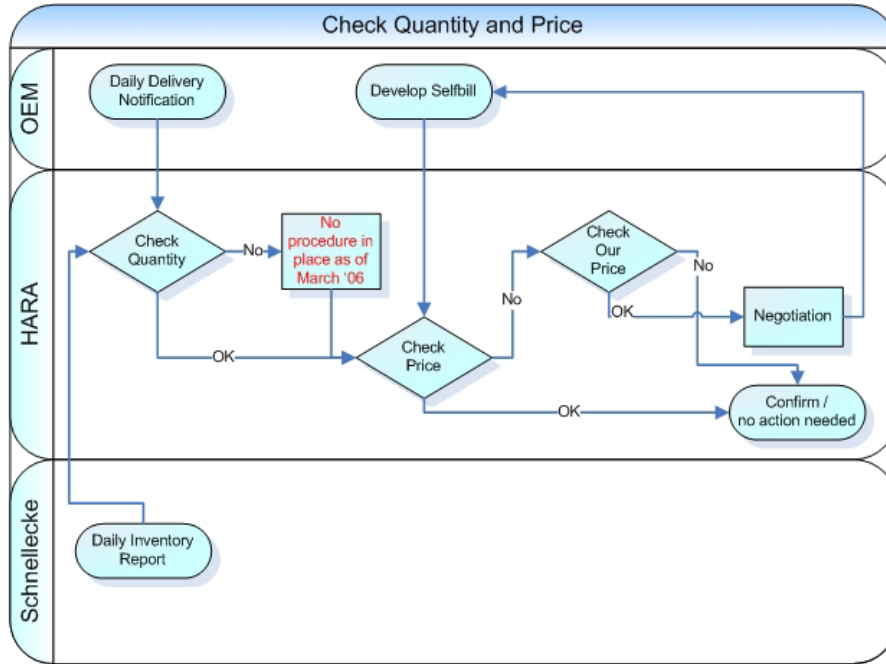

Figure 6-6 - Check Quantity and Price

The number of bumpers is continuously monitored by means of the daily delivery notifications from Audi and the daily inventory reports from Schnellecke. However, if a discrepancy occurs, there is no procedure in place as of March 2006 to handle it. If a discrepancy exists, HARA will use the figures from Audi. This is also one of the reasons for performing a manual adjustment of the MRP as illustrated earlier in Figure 6-4.

Receiving the self-bill from Audi initiates another check; if the price Audi paid for the bumpers are correct and in coherence with the prices HARA has used in their calculations. If the price is the same a confirmation will be carried out and payment received few days after. If, however, the price is divergent, HARA will check their prices. If HARA's internal prices are correct, a negotiation will be initiated. However, if they are incorrect, and the price Audi has set is determined to be correct, a confirmation will be carried out.

In practice, a confirmation implies that no action is taken and the OEM will regard this as a confirmation.

Checking the invoices received from the suppliers bares similar techniques as to the process of checking the quantity and price. Figure 6-7 illustrates the process of the verification of each supplier's invoices.

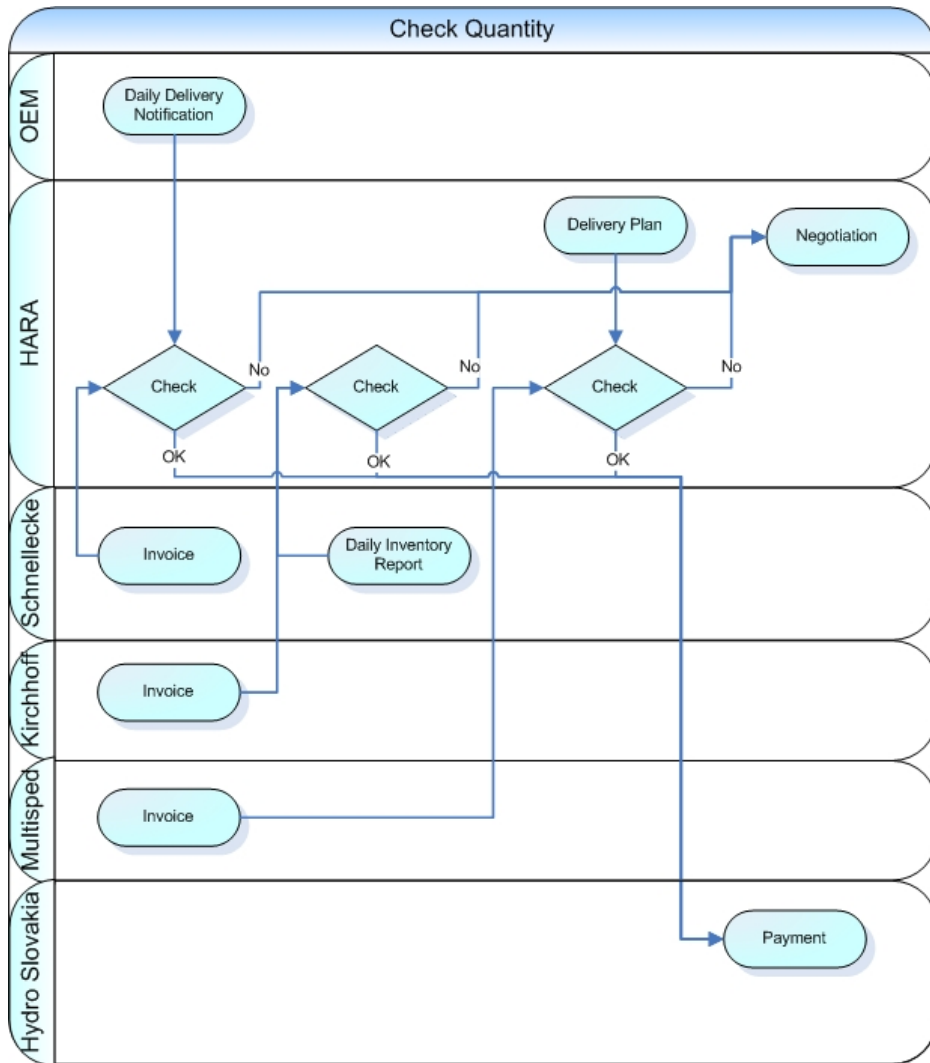

Figure 6-7 - Check Quantity

Invoices from Schnellecke are compared to the delivery notifications from Audi. Invoices from Kirchhoff are compared to the inventory reports from Schnellecke, and invoices from Multisped are compared to the delivery plans. Finally, if an invoice is incorrect, a

negotiation will be carried out. But if correct, payment will be performed by Hydro Slovakia.

The treatment of spare parts is considered as a separate process due its rare occurrence and is illustrated below in Figure 6-8.

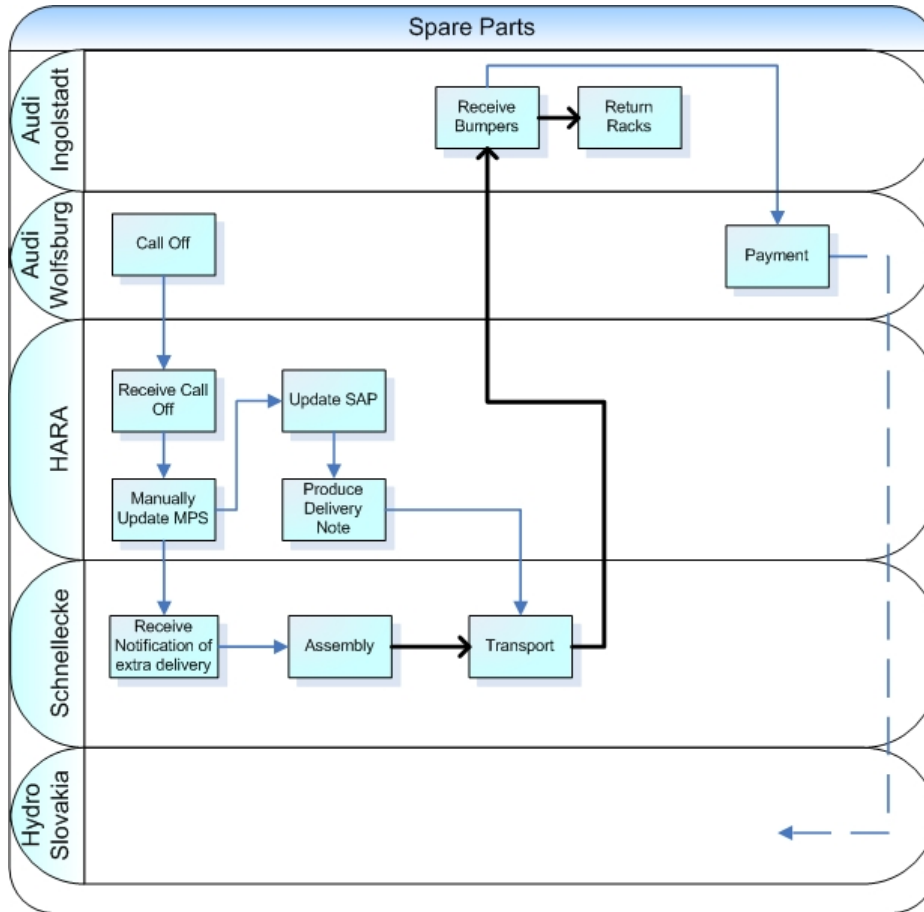

Figure 6-8 - Spare Parts

Audi (Wolfsburg) will perform a call off to HARA. HARA will update the MPS with the extra bumpers needed to satisfy the order. The order is then sent directly to Schnellecke which performs the assembly and transport of the bumpers to Ingolstadt. Meanwhile, the SAP is updated as usual but the delivery note is sent directly to Schnellecke as extra production or shipment from HARA is (usually) not required to meet the demand. Empty racks are returned to Audi Bratislava and payment is performed by Audi (Wolfsburg).

All of the drill downs are accompanied by process descriptions as illustrated in Figure 6-9 below.

MRP PROCESS DESCRIPTION	
Aim	<ul style="list-style-type: none"> <li>Define Production plan</li> <li>Define Delivery Plan</li> <li>Produce a Pro-Forma invoice (Delivery Note)</li> </ul>
Requirements and Goals	Requirements: <ul style="list-style-type: none"> <li>SAP online and updated</li> </ul> Goals <ul style="list-style-type: none"> <li>Define a full production plan</li> <li>Define a full delivery plan</li> </ul>
Input	<ul style="list-style-type: none"> <li>MPS / Delivery Plan</li> <li>BoM</li> <li>Inventory Status</li> <li>Manual Adjustments</li> </ul>
Supplier	<ul style="list-style-type: none"> <li>OEM</li> <li>Schnellecke</li> </ul>
Output	<ul style="list-style-type: none"> <li>Production Plan</li> <li>Transport Order</li> <li>Pro-Forma invoice</li> </ul>
Customer	<ul style="list-style-type: none"> <li>Production</li> <li>Distribution</li> <li>Multisped</li> </ul>
Other Affected Parties	<ul style="list-style-type: none"> <li>Inventory level</li> </ul>

**Figure 6-9 - MRP Description**

This is an example of the MRP process description table. It is in coherence with the standards HARA currently employs and can be extended continuously as more variables/parameters are identified.

### 6.1.3 Interactions

This sub-section will provide greater insight to the different transactions and interactions between HARA and its partners. Decisions and processes of the partners are not discussed as these are external and are in little or no control of HARA. In order to facilitate the discussion, please refer to the former illustration of the PPM given in Figure 6-1 and in section 6.1.2. To better provide a clear and structured discussion of the different interactions this section has been divided into different sub-sections representing all interactions.

#### 6.1.3.1 HARA – OEM

Figure 6-10 illustrates the interface between HARA and OEM (Audi). There exists 7 direct interactions between the two and will be the area of discussion in this sub-section.

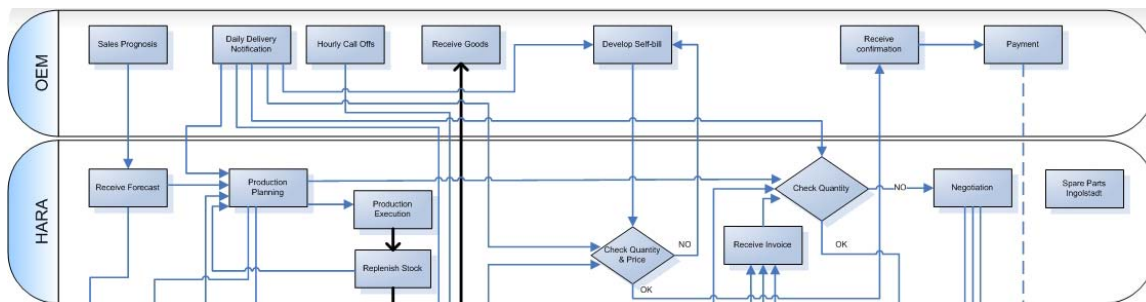

Figure 6-10 - PPM a)

The first interaction between the two is the transmission of the sales prognosis as seen in Figure 6-10. This is performed by means of an EDI transfer, translated by ATHOS<sup>2</sup> ([www.athos.com](http://www.athos.com)) and implemented into HARA's SAP system. This is the most effective way of information sharing across businesses and minimizes human intervention and probability of failure as theory around information system claims (section 3.4). As far as the nature of the prognosis goes, it is a forecast generated by the OEM – not HARA. This (near) eliminates the unpredictability of different forecasting methods and facilitates the process of estimating the MRP, a proper way of managing a VMI consignment stock

<sup>2</sup> ATHOS translates the EDI data into SAP compatible data.

(section 3.3.2). The prognosis covers future demand up to 6 months from point of receipt and is updated weekly, commonly termed a 'rolling schedule'.

Receiving the Daily Delivery Notifications is the second interaction. It is an Excel document sent by e-mail to HARA containing the exact number of deliveries needed for that day used to establish an MRP. This is sent pre-receipt of fully assembled bumpers and it is considered received by the OEM. It is an *aggregate* daily demand and is sent to both HARA and Schnellecke, with Schnellecke also receiving hourly call offs (sequenced call offs).

Each month (covering 30 days of business) HARA receives a self-bill from the OEM by e-mail. This is a common way of communicating invoices and self-bills and will not allow for immediate improvements other than communicating the self-bill through EDI and SAP, though this would not increase the efficiency all that much. The check is assisted by data from the Daily Delivery Notifications from OEM and Inventory Reports from Schnellecke. If the process 'Check Quantity and Price' returns a 'NO' (on the quantity) the self-bill is meant to be sent back with a negotiation notion. However, as earlier stated, a procedure for this is not yet in place (as of March '06) and should be subject to crucial and immediate improvement. Currently, HARA simply trusts the OEM in dealing with the right quantity and will not initiate a negotiation at this point. With better monitoring of the inventory levels at Schnellecke, HARA would be able to initiate a negotiation on the matter. The price of the bumpers is floating, following the market price of aluminum. Establishing a fixed price of the bumpers may prove difficult as a result of this and is considered to hold little or no improvement potential. It may, however, be established a fortnightly or monthly pre-defined price to avoid negotiations and/or time consuming checks each month as the current solution requires.

Each supplier is also checked for the right quantity. The Daily Delivery Notifications are also used in this verification process. This is currently a manual process performed once a month upon receipt of invoices from the suppliers.

The last interaction is sending a confirmation of the self-bill to the OEM. This is actually not a confirmation as such, as earlier described, but rather omitting to take action which is therefore considered as a confirmation. This is not a subject of immediate improvement and works well today.

### 6.1.3.2 HARA – Multisped

Figure 6-11 illustrates the interaction between HARA and Multisped. There exist 5 direct interactions between the two.

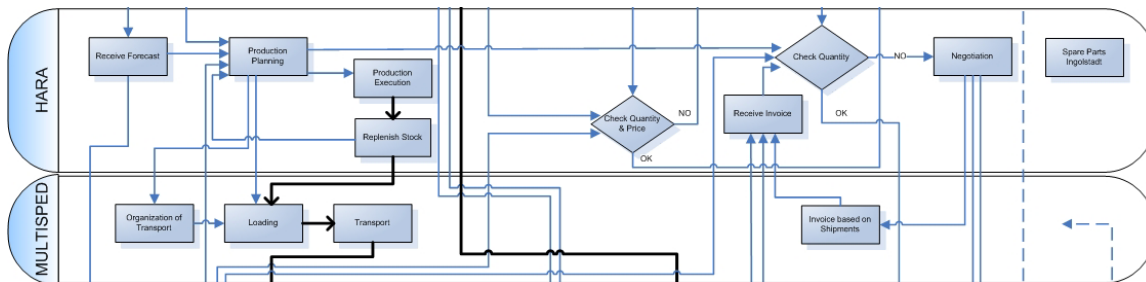

Figure 6-11 - PPM b)

When production planning and delivery planning is performed at HARA, this also initiates a transport order sent by e-mail to Multisped. At the same time, a pro-forma invoice is created by SAP that Multisped needs for customs clearance on the German border (Rostock). The pro-forma invoice is printed at HARA and a delivery man is sent to pick it up, for then again deliver it to Multisped. This involves potential improvement and may simply be sent to Multisped by e-mail – rationalizing the delivery man thus, reducing the re-capturing of data explained in information systems (section 3.4.1).

Loading the trucks is the first material flow interaction. This is done by, as explained above, receiving a transport order, issuing a truck, loading and receipt of the pro-forma invoice. The method of loading has some improvement potential, such as ‘direct loading’<sup>3</sup> and is also currently considered by HARA and Multisped. By employing direct loading HARA may rationalize their inventory at Raufoss and cut costs in accordance

<sup>3</sup> Direct Loading: A container is dedicated to the loading facility which is continually loaded. When full, the container is replaced by a new container, and the full one is driven away.



with Lean principles. However, there is a tradeoff. While reducing the holding costs, having trucks waiting for loading, will increase the transportation costs.

In the event of loading a truck the outtake is reported to SAP. SAP considers this an input to the Schnellecke inventory as described in section 6.1.1. This may prove unfortunate in the event of an accident, or similar, during the transportation. The materials in transit should be considered as *in-transit* to define the location of the bumpers and not considered as *in-stock* at the consignment stock in Slovakia. It should be updated when received and counted for in the daily inventory report, and is assumed to constitute some of the deviation in the inventory reports.

Invoices, sent by regular mail, are checked towards data from the OEM, MRP and Inventory Reports from Schnellecke. Negotiation may also take place if discrepancies occur. The transaction of invoices may also be more effectively transferred, for instance by e-mail.

### 6.1.3.3 HARA – Schnellecke

The HARA-Schnellecke relation exists of 5 direct interactions as illustrated in Figure 6-12 below.

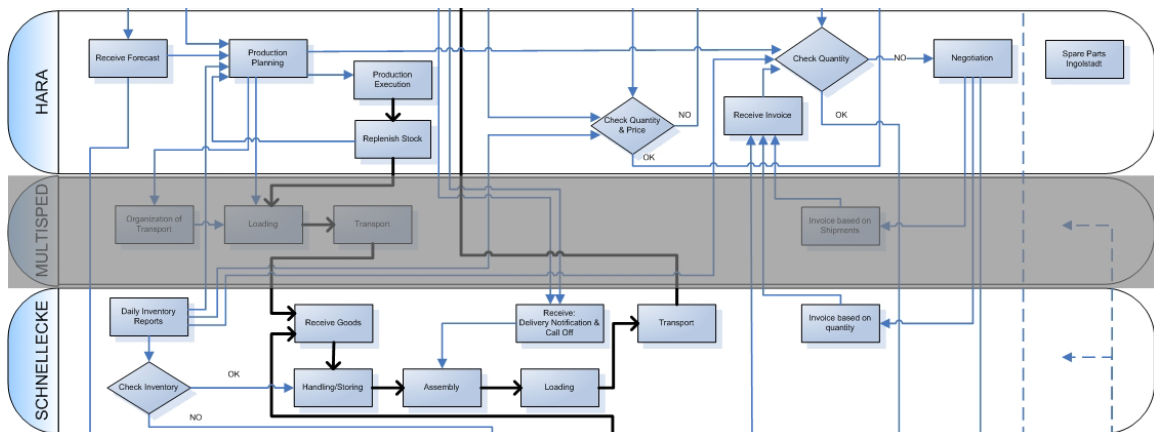
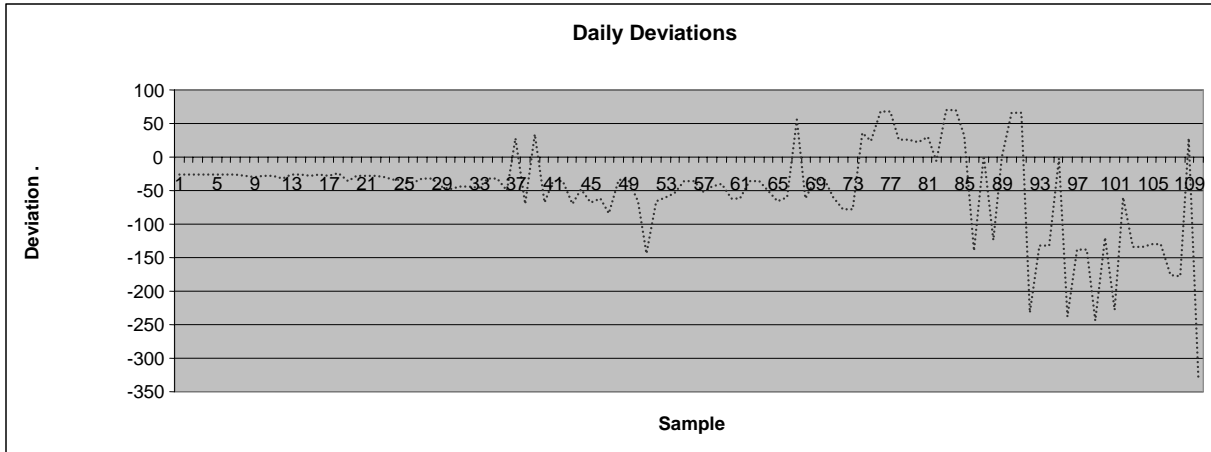

Figure 6-12 - PPM c)

Communicating the Daily Inventory Reports carry the most improvement potential. This information sharing is crucial for the creation of an MRP and successfully managing the VMI consignment stock. Thus far, the main challenge is monitoring the inventory at

Schnellecke. Due to different reporting times, discrepancies in the inventory level arise. Investigation into the inventory reports from Schnellecke checked towards the reports from the OEM revealed the inventory deviations rendered in Figure 6-13 below.



**Figure 6-13 - Daily Deviations**

**Figure Description:**

Reported received amount from Audi – (minus/subtracted)  
Reported dispatched amount from Schnellecke

The figure presents the daily inventory deviations (at the consignment stock) from 1.1.2005 until 04.24.2006. It shows an average of negative 56 fully assembled bumpers over an approximate 4 month period. Each conspicuous peak is a result of different reporting times, and is not adjusted the following week or month and shows evidence of the ‘bullwhip’ effect. Disney and Towill [12] conclude in their report that “VMI reduces the bullwhip effect – typically halving the effect”. Therefore, it is assumed that experiencing such obvious evidence of the bullwhip effect is a sign of poor management of the VMI consignment stock and is an area of much improvement potential as it may prove difficult to establish a correct MRP with incorrect levels. Currently both Schnellecke and Audi reports inventory levels and outtakes each day but at different times. Audi will report their amount of received bumpers at the end of the day while Schnellecke has no fixed reporting times and will count the bumpers whenever they have available time to do so. Schnellecke has in addition to this no routines for reporting or informing HARA with bumpers that fall outside the quality limits. Whenever a bumper is rejected for its quality it is simply put aside without being reported. This is also a reason

for the discrepancies illustrated in Figure 6-13 on the preceding page, and occupies extra resources which are not in accordance with Lean Principles.

The logistics department at HARA have tried to establish a common reporting tool (in form of an excel document) to mitigate and maybe rationalize the problem but it has not (as of April '06) been adopted by Schnellecke. The authors suggest that tools that can enable real-time data to be sent to HARA concerning the levels at Schnellecke could be a way of improving the management of the VMI consignment stock. Barcodes on each rack containing the bumper beams have been attempted but have failed as the warehouse at HARA (mainly) and Schnellecke has not been constructed in an ideal way to employ this tool successfully. A successful implementation of barcode technology requires the inventory to be designed in a way that the inputs and outtakes are performed through a lock system providing the barcode reader with a line-of-sight to read the barcode. This has not been taken into consideration upon designing the warehouses at HARA and Schnellecke. Thus, it is suggested that RFID as a real-time information sharing tool may be used to improve the management of the supply chain and an introduction to RFID will follow.

## **RFID**

Figure 6-14 on the next page shows an imaginary use of Radio Frequency Identification (RFID) controlling and monitoring the material flow at Schnellecke or/and HARA.

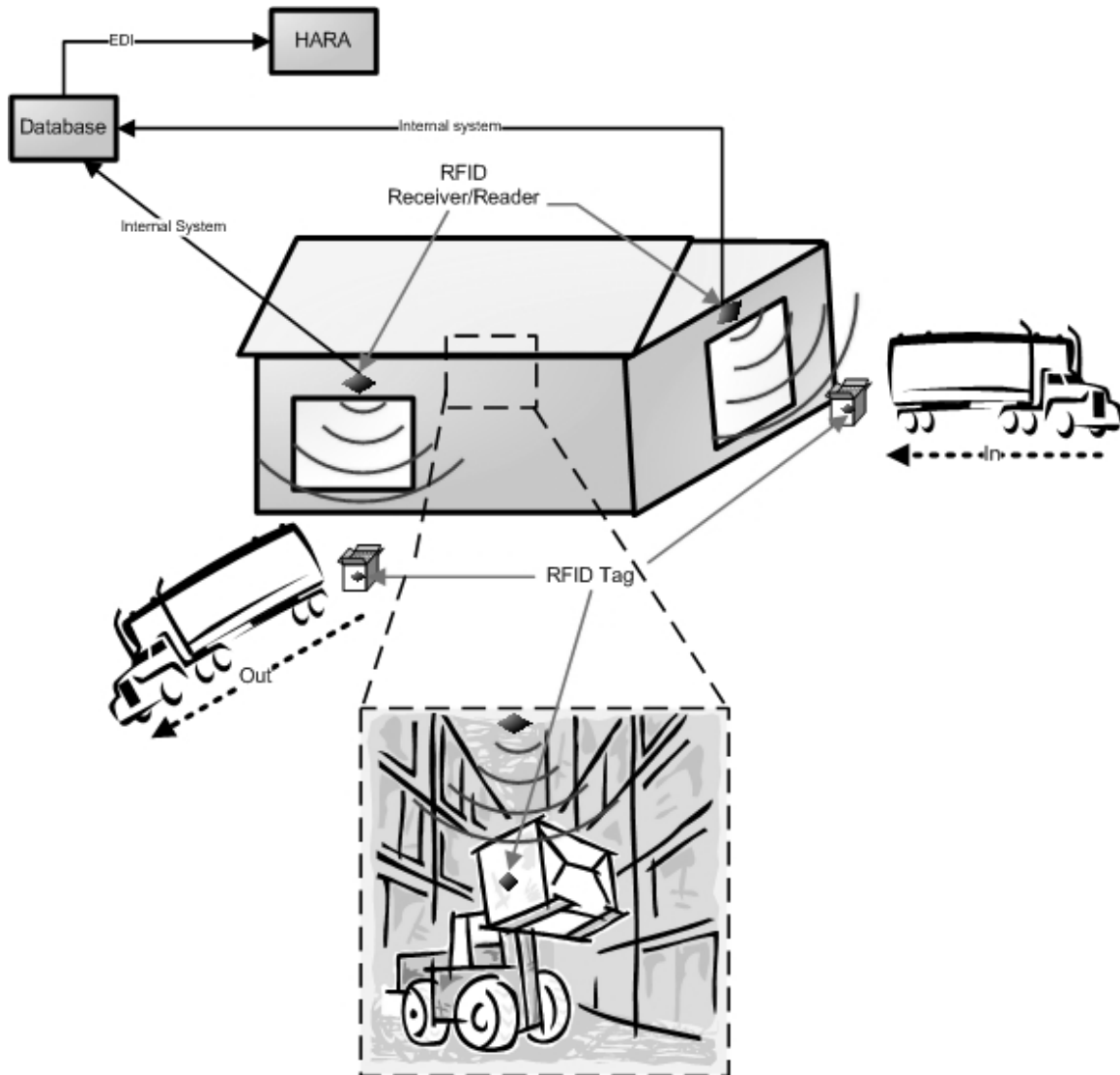

Figure 6-14 - Use of RFID

The above figure illustrates the use of RFID being used to manage the input and outtakes of the warehouse. Unique RFID tags are mounted to each rack and read by a sensor/reader on its way into (and out of) the warehouse. They are linked up to a database which in turn estimates the inventory but there may also be a direct link to HARA which calculates the inventory. Information about the inventory level, input and outtakes can be transferred by a simple EDI link, which may be integrated into SAP to directly estimate the MPS and MRP. It can also form a better foundation for a possible negotiation discussed in section 6.1.3.1. Below the warehouse, an extraction from within the warehouse is represented using RFID as a *controlling* device for the inventory. This is

possible because in contrast to the barcode the RFID tag does not require a line-of-sight. This type of monitoring requires, however, more expensive equipment than just monitoring input and outtakes.

There are numerous variations of these tags available suited for different operations. They are divided into *passive* and *active* tags, and then low, high and ultra-high frequencies (UHF). The passive tags are the cheapest ones as they draw power from the reader, which sends out electromagnetic waves. These electromagnetic waves are stored momentarily (milliseconds) and sent back to the sender at another frequency – representing the data they contain. Active tags come with its own power supply (e.g. batteries) and can send information to any receiver or sensor within (a longer) range. This comes with an increase in price but they involve a much larger range with the capability to send information to satellites<sup>4</sup>.

The difference between the frequencies is the required power, distance and application. Low frequency tags will be difficult to use in an environment full of steel and metals. The low frequency beams will be reflected by steel and will not reach the tags, or (with active tags), not back to the sender. High frequency tags are preferable as they are not as much reflected by steel as low frequency tags are. UHF usually works better with a close to line-of-sight environment, with longer read range but larger energy consumption.

RFID tags are also more robust than a barcode. While a barcode easily can get a small rift rendering it useless and unreadable, a RFID tag can withstand water, blows and general strain.

#### **6.1.3.4 HARA – Kirchhoff**

The interactions between HARA and Kirchhoff are illustrated in Figure 6-15 and contain three interactions.

---

<sup>4</sup> These tags are used by the military and their price is not justifiable for use in the manufacturing environment and their size and weight are too large.

An Assessment of Hydro Aluminium Structures' Supply Chain to Audi  
 Requirements, Development & Improvements to an International Automotive Supply Chain

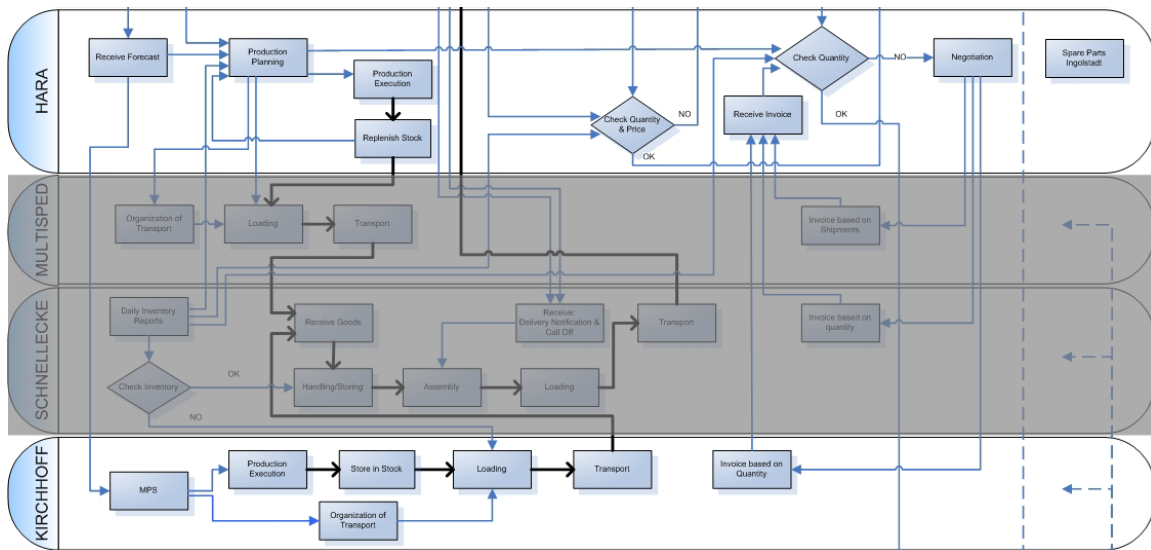

Figure 6-15 - PPM d)

The same sales prognosis received from the OEM is sent to Kirchhoff by e-mail. This is a simple screen shot of SAP representing the following weeks' and months' estimated demand and forms the basis for Kirchhoff's MPS. Kirchhoff is almost operating independently from HARA and is just concerned about maintaining the service level at Schnellecke. There exists some potential improvement in sending the prognosis directly from the OEM to Kirchhoff but it is far from essential. Kirchhoff is also expected to have implemented SAP sometime during the fall of 2007 which may increase the efficiency of this information sharing somewhat. The two other interactions are validation of the invoices sent from Kirchhoff and, if needed, the appurtenant negotiation.

### 6.1.4 Summary

Each improvement suggestion defined in the previous section is below summarized in Table 6-1 on the next page.

#	Area	Concern	Suggestion
1	Material Resource Planning	Different Reporting Times. Resulting in extreme deviations in inventory. Extent: <i>Major</i>	A new technique for reporting inventory levels. RFID (or similar) may be a solution for real-time information sharing.
2	Transportation	Inefficiency. Unnecessary costs and time associated with the use of a mail man. Extent: <i>Minor</i>	A new way of exchanging the pro-forma invoices. E-mail of pro-forma invoice to Multisped.
3	Verification of Payment	No Procedures in Place. Naivety towards customer. Extent: <i>Major</i>	Better practices in the verification of Quantity and Price of bumpers.
4	Loading	Increased holding costs Extent: <i>Minor to Medium</i>	Direct Loading of trucks/containers at HARA
5	SAP	Information imperfection Extent: <i>Minor to Major</i>	Establish a new 'inventory' for in-transit products

Table 6-1 - Improvements

### 6.1.5 Implementation Issues

The improvements suggestions summarized in Table 6-1 will in this section be prepared for implementation followed by a cost-benefit diagram.

#### # 1 – A new technique for reporting inventory levels

There is already evidence of successful implementation in the automotive industry with RFID technology ([www.rfidjournal.com](http://www.rfidjournal.com)) as illustrated in Figure 6-16 below.

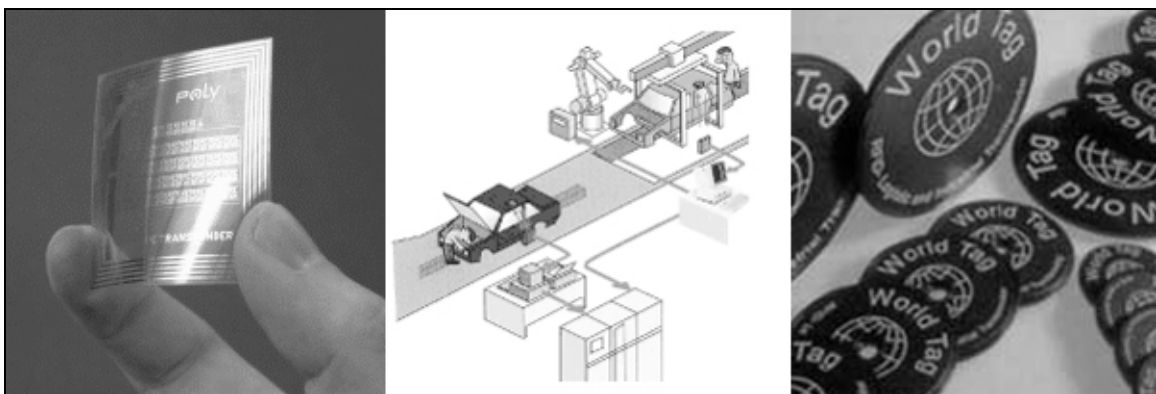

Figure 6-16 - RFID Tags [compilation from [www.rfidjournal.com](http://www.rfidjournal.com)]

Avery Dennison ([www.iapna.averydennison.com](http://www.iapna.averydennison.com)) has developed a new 'metal track RFID' that is tailored for the automotive industry. The passive Ultra High Frequency (UHF) tag promise at least 20 feet (approximately 6 meters) range in an automotive environment. They report that the price of a tag is at most \$6 USD (about 37 NOK<sup>5</sup>) decreasing as quantities increase. Symbol Technologies Corporate ([www.symbol.com](http://www.symbol.com)) offers RFID portals (scanners), as illustrated in , that can be placed along the docs of a warehouse with quotes starting at \$4.999 USD (30.515 NOK<sup>6</sup>) and up.



Figure 6-17 - RFID Portal [[www.symbol.com](http://www.symbol.com)]

Implementing RFID technology is expensive, and in addition to the cost of tags and antennas, the cost of software and middleware is added to the investment<sup>7</sup>. However, as the racks containing the bumpers are reused the tags may be used repeatedly – provided they are rewritable. They will provide real-time information which can be used to successfully monitor inventory levels as well as outtakes from Schnellecke as well as monitoring the location of the very racks – at any give time. Hence, as bumpers are taken of the racks and the racks are reduced, the RFID tag may be updated with its new amount. This use of RFID is synonymous and accommodated with Electronic Kanban (eKanban).

Using RFID technology to monitor the inventory levels (not just input and output) requires, however, several readers strategically placed throughout the inventory to cover the entire area and will lead to greater costs than just monitoring inputs and outputs. This

---

<sup>5</sup> 1 NOK = 6.1042 USD (May 9<sup>th</sup>, 2006)

<sup>6</sup> 1 NOK = 6.1042 USD (May 9<sup>th</sup>, 2006)

<sup>7</sup> IDzone prices of implementation: up to 180,000 DKK (187,938 NOK)



is suggested to have no immediate additional functionality if input and output are monitored successfully. Implementation of RFID can also be used to compare the daily delivery notifications from the OEM with reported output which will lead to a better practice in validating quantity and price as suggestion #3 describes.

Implementing a brand new monitoring tool is obviously associated with a great amount of cost, not only in monetary form, but just as much in other resources. Therefore, will the use of RFID tags as here described be a major decision for HARA. If this is not implemented a more structured common inventory report must be in place as soon as possible. Here reporting procedures must be in accordance, time and type, and the fashion of which the data is transmitted, with the reports HARA receives from OEM to minimize the reported deviations.

#### **# 2 – A new way of exchanging the pro-forma invoices**

Employing a delivery man is unnecessary and can easily be rationalized by transferring the pro-forma invoice per EDI. Transportation orders are currently sent per e-mail to Multisped and there is no evident reason why this also could not apply to the pro-forma invoice. Rationalizing this process will immediately provide savings in both time and money (cost).

#### **# 3 – Better practices in the verification of Quantity and Price of bumpers**

With the use of a RFID system HARA will be better equipped with information and documentation that they can use in negotiations and monitoring of the amount of bumpers the OEM buys. The RFID system can be implemented into SAP and provide full documentation of the outtakes from Schnellecke. This may also be implemented and/or transmitted to the OEM as a confirmation from their side.

#### **# 4 – Loading**

Holding costs at HARA may be reduced by means of employing 'direct loading'. It will, however, increase the transportation costs somewhat but is perceived as a way of reducing overall costs.

## # 5 – SAP

A new 'inventory' record should be established in SAP to account for the products that are in-transit. If products on the way to Schnellecke are exposed to, or compromised by, an accident (for example) these products will still be considered as in-stock at Schnellecke. If the products were regarded as in-transit instead, and would be regarded as in-stock when they *arrived* at Schnellecke, it would be a more accurate way for maintaining control of the inventory levels. This will also reduce the deviation between the 'inventory at Schnellecke' registered in SAP and the 'daily inventory report' from Schnellecke for periods when products are in transit.

### 6.1.6 Cost and Effect

In Figure 6-18, the improvement suggestions have been mapped according to their *estimated* cost and effect relative to their application. An RFID system (#1) is expensive but at the same time provides huge savings (mainly time and control) and is therefore mapped in the top right corner, denoting large costs but at the same time large effect.

Suggestion #2 has been mapped in the bottom left with negative costs denoting that this is an immediate saving but with rather little effect on its application.

Being able to successfully monitor the inventories (#3) is a direct consequence of implementing a new monitoring tool (RFID). It is therefore mapped in the top left corner, with no immediate *additional* costs, if an RFID system is already implemented. It bears, however, significantly effect prospects such as holding cost savings and increased control. Suggestion #4 will reduce the holding costs but at the same time increase the transportation costs. As no data has been reviewed to establish the exact position of this suggestion, it is plotted against an *expected* efficiency.

Suggestion #5 is not plotted since there are no real costs associated with the new 'inventory'. It is perceived, however, that the new 'inventory' will increase the control of the consignment warehouse which can help monitoring the levels and thus reduce unnecessary inventory and appurtenant costs.

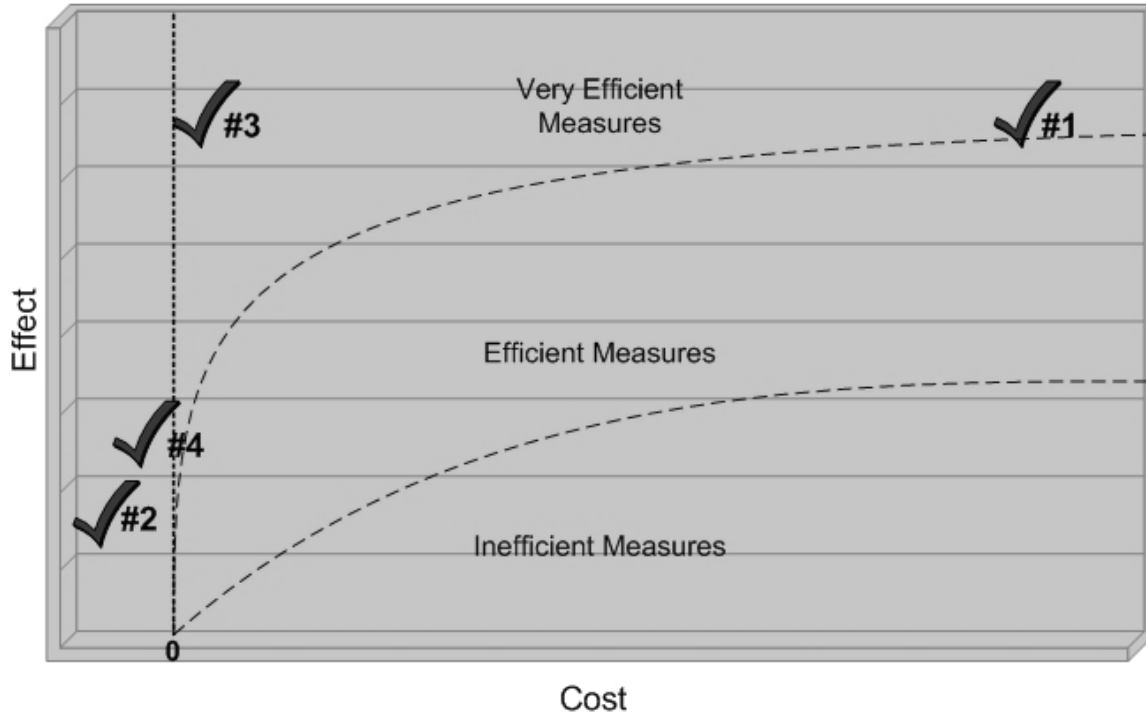

Figure 6-18 - Efficiency of the Measures

## 6.2 Project Development

Interviewing personnel from different departments about the progress and execution of the 'Pikes Peak' project revealed some information that will be discussed closer. It is a united apprehension that the design of the product and the product development phase has been successful while other parts, like the logistics, have been trailing behind. Even now, when the product is in series production, the logistic solution is behind schedule. Product development of aluminum bumpers is a part of HARA's core competence and they have a long history and experience that ensures success. Thus, HARA should be confident enough to diversely allocate resources in a balanced manner across different departments in a project, equally to the concurrent engineering principle discussed earlier. It is perceived that all resources and time in the beginning of the project was used in the development phase of *designing the product*, while other parts like logistics and purchasing came in at a later stage and was allocated less resources. If this is the case, the project was not following its guided path described earlier.

Emphasizing the significance of concurrent engineering, there often exist mental barriers between technical and commercial departments inside a company structure. This can interrupt the information flow inside the company and have a negative effect on the development activity [25]. Following this, from a concurrent engineering perspective, it is important that all different teams are included at early stages of a project.

Different opinions concerning how well this project followed the guidelines have been expressed, but it has not been possible to produce any project progress plan or work plan that can confirm or disprove any of these opinions. It is, however, a major sign of inadequate information sharing both within HARA as well as external.

Ways of improving the project development process may include some sort of supply chain management tool. The following section will assess the present SCM tool and compare two alternative SCM tools. The section concludes with providing recommendations for HARA.

### **6.2.1 Present Supply Chain Management tool**

It has been revealed that the LPSR was not followed when implementing this complex supply chain solution, and is therefore believed to be one of the major reasons for the project's delay. In fact, another similar complex project called 'B58', has followed the LPSR from the beginning and is now, at the time of writing, 5 months prior to planned series production start, already ahead of the 'Pikes Peak' implementation of the logistic solution. This indicates that the value of respecting and employing the LPSR as a structured way of designing a project may be useful.

An investigation into the different tasks in the LPSR reveals the following instructions supporting each task depicted in Table 6-2.

<b>Define Logistic Project Team</b>	The SCL confirm the logistic-team in this projects (coordinator and 1 contributor by involved plant)
<b>Establish link to Customer Internet Portal</b>	Create connection to customer logistics departments, 3PL,suppliers
<b>Value Stream Mapping (VSM)</b>	Establish a VSM and define in this way the future lead-time of global flow
<b>Agree on final flow concept</b>	Define the final flow concept, which should be worked out in deep detail
<b>Confirm packaging type and needs</b>	Internal or/and external, calculation of packaging need (refer to Round-trip Index document)
<b>Confirm transport solution</b>	Agreement for chosen transport(customer, suppliers, distributor )
<b>Confirm solution for VAT</b>	Create the way/responsibilities for VAT handling
<b>RFQ for 3.Party logistics</b>	Ask quotation with involvement of purchasing
<b>Test &amp; approve packaging solution</b>	Confirm unit load for selected packaging
<b>EDP3 Logistic cost validation-revised</b>	Official confirmation (mail) of eventually adjusted logistic costs

**Table 6-2 - LPSR instructions**

The table above is not the LPSR instructions in full, but an excerpt from Core 3 representing the logistic department's tasks (see Figure 5-6). Even at a mere glance it seems far too simple with important tasks inadequately defined. Some instructions are close to thoroughly defined but, altogether, the LPSR seems superficially described and allows for individual interpretation and different approaches depending on the person/team dealing with that particular task's outcome. An instruction sheet like the LPSR should have a thorough task description and definition, split up or drilled down to establish a more complete task description so that everyone can understand what exactly the outcome of each task should be.

The design of instructions, such as the LPSR, should be made as finite and as precise as possible. That way it would not allow for individual interpretation of the tasks – that should have been prepared by a cross functional team – and should be a part of the business policy to follow. If not a pre-defined, set and constituted procedure, it should involve clearly defined requirements for each process. E.g. <Confirm solution for VAT> is defined as 'Create the way/responsibilities for VAT handling'. This is imprecise and

should be supplemented with a checklist of crucial and important sub-oriented points and statements.

It exist evidence that the LPSR, as already mentioned, was not used during this project. In addition there are evidence that different departments where not clear in their specific responsibilities during the project. This supports the assertions of a poorly designed project plan and project task specification, and is an important field of improvement. Then again, keeping the success of the 'B58' project in mind, the LPSR seems adequate for designing the project. However, it is the author's convincement that the LPSR is only *adequate* – and allows for several major improvements to render a specific, more profound, guideline.

Hydro has, as mentioned earlier, developed a set of project processes as illustrated in Figure 6-19. An extremely valuable tool consisting of top-level processes with drill downs into more specific sub-processes and then specific instructions. In Figure 6-19, is the 'Change Handling Processes' drill down adapted from HARA's intranet. The example is provided to illustrate the detail of which each process is in fact described. All these processes constitute the basis for the LPSR. It is a well defined Business Process Map – mapping every single process in great detail. Supporting each process lays a process description table. It lists the inputs (supplier), outputs (customers), requirements, aims and goals for the process, plus some 'criticality' elements, similar to the table illustrated in Figure 6-9.

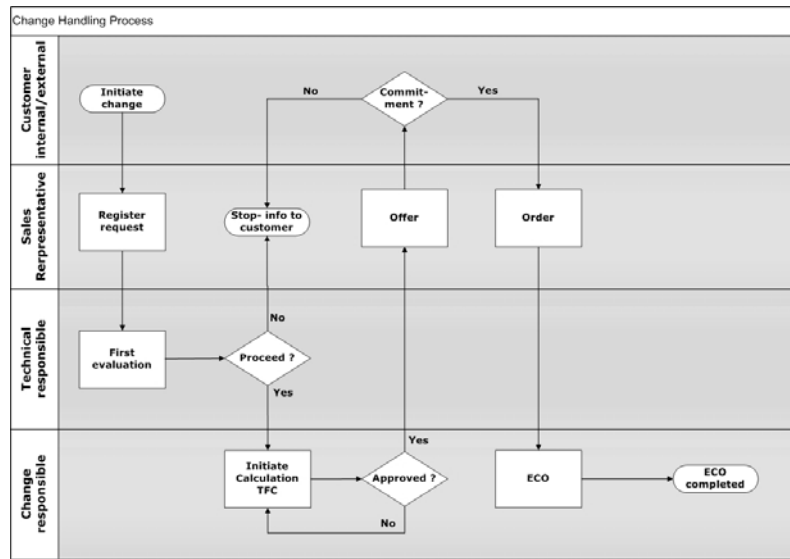

Figure 6-19 - Change Handling Process

It is the author's opinion that, after speaking with numerous people at HARA, this tool is not adopted in full. In the 'Pikes Peak' project it may have been the *official* path of the project but not the *actual* path. The LPSR should work as a superior guideline and a shopping list for what processes are crucial to the project in various stages. When (for example) <establish link to Customer Internet Portal> (refer to Table 6-2) is performed, the Business Process Map should be factored in and be followed in order to 'get things right'. In addition, when the LPSR is not followed at all, things could get chaotic – as they also have.

It is recommended that the LPSR should be embraced to its full. It is not a complete and comprehensive enough guideline, and it allows for major improvements, but it is a start and a shopping list of what is crucial to the logistics part of the project. In addition the Business Process Map should be taken more into consideration. Although it is understandable, but not at all justifiable, that experienced employees do not *feel* like they need to use them, it is equally important to have the base-principles right – every time – in order to get achieve an effective development and running project. However, it is also important to take into consideration what General George S. Patton Jr. ([www.generalpatton.com](http://www.generalpatton.com)) said; "Never tell people how to do things. Tell them what to do and they will surprise you with their ingenuity", each and every process does not have to

be predefined and set so that it will not allow for any flexibility and ingenuity. As the projects are performed and ran it may allow for improvements that only experience – and not theory and assumptions – can reveal. It is consequently important to find a balance between to clearly define the processes and activities, and at the same time allow for ingenuity and creativity. It is, in the end, a precisely defined *outcome* of the process or activity that is important, not necessarily *how* to achieve it.

### **6.2.2 Other Supply Chain Management tools**

A comparison of the two other management tools, SCOR and MMOG/LE described in respectively section 3.3.5.2 and 3.3.5.1 will be provided in this section.

Both the ODDETTE/AIAG's Logistic Evaluation and Materials Management Operations Guideline (MMOG/LE) and The Supply-Chain Council's SCOR model attempt to be a management tool for implementation and evaluation of supply chains in addition to be a tool for continuous improvement. The tools has several similarities but also differences that separate them considerably.

The primal distinctive feature of the MMOG/LE is that it is a checklist – a common set of guidelines for materials management. It is a self-assessment tool that enables companies to rank their material planning and logistics performance to gain guidance towards best practice within an industry. It outlines processes whereby everyone can understand what is meant by *world class*. It sets up a procedure to measure, through self-examination and observation of suppliers, any organization's capabilities for material management. – It is, actually, the document in place to support the material flow side of lean practices – a predefined way of assessing a company.

SCOR, however, is a model – a broad framework – to help translate business objectives into operational objectives. It is a standard set of high-level business process/activities within a department or domain, right down to a shopping list of metrics and over 300 different key performance indicators (KPIs).



While MMOG/LE is solely prepared to deal with the material handling, SCOR is better equipped with multiple 'branches' that may be employed by several departments in the company. The MMOG/LE guideline requires the entire program to be filled out in order to provide the user with a final grade. SCOR, on the other hand, has no such requirements and can be implemented to the extent of which the user desires. – For the material handling, for the production, or for the entire company and its business objectives.

Even though SCOR seems grander and more spectacular, the fact remains that MMOG/LE is tailored for the automotive industry, and that of which material handling is already incorporated into the guideline. SCOR can be used for every industry, incorporating 'every single' KPI that exists and is not of a 'narrow minded' nature which MMOG/LE is. Further, the SCOR model opens for user-selected KPIs. This means that the SCOR model may be customized and uniquely prepared for any user – automotive, retailer, car hood manufacturer or bumper manufacturer – being a very versatile management tool. These customized KPIs can also be selected to best reflect the company vision and their business objectives.

Another valuable benefit from the simplicity of the MMOG/LE guideline is that evaluating future (or current) suppliers is much easier. During a bidding round the customer may give the supplier a MMOG/LE sheet, and a quick glance at the final result of the supplier determines if the supplier is eligible or not (provided an honest execution and documentation of course).

Consequently, if only the material handling and logistics are to be scrutinized, the MMOG/LE is a very useful tool for improvement. If the whole supply chain is to be scrutinized, employing MMOG/LE alone will not be sufficient as the guideline does not handle a wide enough spectra of performance measures and processes. Therefore, MMOG/LE may be used for parts of the supply chain management – the automotive specific material handling – but when dealing with the whole chain other tools must be employed – such as the SCOR-model.

HARA has previously employed this automotive management tool (MMOG/LE) but have abandoned it, and as of March 2006 HARA have not yet employed any such tool (other than the LPSR). It is therefore recommended that HARA adopts some sort of management tool as soon as possible in order to improve different aspects of the business. As far as selecting which tool to employ based on characteristics and its application areas, one can discuss back and forth. The authors recommend MMOG/LE as the appropriate and suitable tool due to HARA's previous experience with the tool and the research approach of this Thesis. In addition there is evidence of lack of structural practices upon designing a new supply chain. Internal checklists (LPSR) have either been inadequate or not properly put to use. Resuming the 'best practice' represented in the MMOG/LE guidelines is assumed to have positive effects on the design of a supply chain as well as continuous improvements on several important performance measures. Observations during the interviews at HARA insinuate that communications across different departments within the company is not consistent with concurrent engineering and continuous improvement of the supply chain. The MMOG/LE is a tool for facilitating communication of performance measurers in a more comprehensible way across multiple departments within the company. In addition, it is also a common used management tool in the automotive industry – as it is tailored for that very industry.

However, upon improvement of the whole supply chain, and the business, a more extensive tool, such as the SCOR model – mapping and defining many more aspects of the business – is needed. This will, however, require extensive use of resources upon implementing and learning the new tool, but it is perceived to have positive effects, using it as a model or reference when designing and implementing a new supply chain.

### **6.3 Contractual Agreements**

This section looks at the different agreements HARA have with its partners in the supply chain. The relations will be compared and analyzed on basis of Principal-Agency theory to predict the different actors expected behavior and justify a contract type.

Contract in agency theory is a wide expression that covers the entire relationship between two parties and is used as a mechanism to explain and analyze the relationship. This is discussed more in detail in the Principal-Agent theory section and is important to bear in mind when reading this section. The contracts between each partner and HARA will be analyzed with respect to the propositions in Table 3-2. This will allow justification of one type of contract over the other (Outcome-based vs. Behavior-based) and explain the agent's expected behavior. The information is gathered in form of interviews and written formal contracts. The formal contracts are the commercial agreement that is the overlaying agreement about purchase and payment conditions and the logistics agreement which handles all arrangements with respect to the logistics process, and can be seen as *private ordering* explained in Transaction cost (section 3.1.3). The logistic agreement will in the last section be compared with Odette's "Guide to Logistics Agreement" developed for the European Automotive industry to suggest possible improvements. Odette's guide sets out to give a recommendation and a check list to create a company specific agreement.

### **HARA – Schnellecke**

HARA buys a service from Schnellecke, which makes HARA the principal in this relation. HARA pays a price per assembled bumper, which makes the contract type outcome-based and the risk lies on the agent. However, looking at the entire supply chain, HARA is responsible for the bumpers until they are delivered to the Audi plant and therefore carries a great deal of the risk as well. Relating to the power situation in this relationship, it should be noted, that even though the principal here buys a service from an agent, it does not necessarily mean that the principal is in a favored power situation. The reason for this is that HARA's use of this agent was forced upon by the OEM and HARA can not easily change to another 3PL.

HARA has an information system that makes it easy to measure the outcome from the 3PL and also the quality is measurable with an outcome-based technique. This favors an outcome-based contract. Both parties are ultimately trying to serve the more powerful OEM and are therefore likely to try to shift the risk over to the other part, which again favors the outcome-based contract. There is no reason to believe that there exists a

significant goal conflict in this relation and the agent's tasks are reasonable easy to program, by for instance using the project process map. This supports the use of a behavior-based contract. In a new relationship, where the principal does not know the agent well enough yet, the Principal-Agency theory proposes the use of an outcome-based contract. Overall, see Table 6-3, the theoretically based choice supports the existing outcome-based contract.

Factor	HARA-Schnellecke		Theoretical contract seen from the principal
	HARA	Schnellecke	
Information to verify behavior	Only Quality and outcome Observable		Outcome-Based
Risk Attitude	Averse	Averse	Outcome-Based
Desired Goal	No significant conflict		Behavior-Based
Programmability	High Task Programmability		Behavior-Based
Measure Outcome	Easy Measurable		Outcome-Based
Length of Relationship	New Relationship		Outcome-Based
<b>Current Contract: <i>Outcome Based</i> Theoretical Contract: <i>Outcome Based</i></b>			

**Table 6-3 - Identification of theoretical favored contract type in the HARA - Schnellecke relation**

### **HARA – Kirchhoff**

HARA buys steel brackets from Kirchhoff. They pay per bracket which also includes transportation to Schnellecke, Bratislava. Thus, the contract is outcome-based and the risk lies on the agent, Kirchhoff. This is an ordinary buyer-seller relationship where the buyer can only observe the outcome from the seller and therefore supports an outcome-based contract. Both parties are looking to cut costs and increase profit and will therefore have contradictory goals and try to shift the risk to the other part. Both of these behaviors support an outcome-based contract. Kirchhoff also supplies the automotive industry with bumpers, which enhances the goal conflict argument. The task programmability in this case is reasonable easy and by the use of a business process map the different processes can be identified and described. This point to a behavior based contract. The relationship with Kirchhoff as an agent is new for HARA, thus they can not easily assess Kirchhoff's behavior. The location also makes the information asymmetry greater and supports the outcome-based contract. Summarized in Table 6-4, theory suggests an outcome-based contract which is consistent with the current contract.

Factor	Current Situation		Theoretical contract seen from the principal
	HARA	Kirchhoff	
Information to verify behavior	Only Outcome Observable		Outcome-Based
Risk Attitude	Averse	Averse	Outcome-Based
Desired Goal	Significant Conflict		Outcome-Based
Programmability	Programmable		Behavior-Based
Measure Outcome	Easy Measurable		Outcome-Based
Length of Relationship	New Relationship		Outcome-Based
<b>Current Contract:</b> <i>Outcome-Based</i> <b>Theoretical Contract:</b> <i>Outcome-Based</i>			

Table 6-4 - Identification of theoretical favored contract type in the HARA - Kirchhoff relation

### HARA – OEM

OEM buys bumpers from HARA, thus OEM is the principal in this relationship and HARA the agent. The supply risk lies therefore with HARA and OEM decides the contract type. However, the authors will here try to investigate it on the same principles as above. It is HARA's responsibility that the assembled bumpers are delivered to OEM at the desired time and right quantity. OEM can easily measure the outcome and has also a good insight to the agent's costs. In addition, due to the power position, OEM has chosen the VMI partner (Schnellecke) and can, through their close relationship with them, get information about HARA's behavior. This justifies behavior-based contract. The principal will in this relationship, due to its power position, not feel any risk aversion while the agent will try to minimize the risk. This again, based on the principal agency theory, justifies a behavior based contract. There is a significant goal conflict in this relationship. OEM, being one of the leading automotive manufacturers, demands a supply chain strongly influenced by Lean and Just in Time philosophy while this is not always the best for the supplier. Seen from the principal, this favors outcome-based contract. The task programmability, seen from OEM, can not easily be identified, while on the other hand, the outcome can be. This also favors an outcome-based contract. HARA has been supplier for OEM in many years and the relationship has made OEM more aware of the agent's behavior and made the information asymmetry less. From this perspective it makes behavior-based contract more attractive. Theoretical justification of this contract lies somewhere between an outcome-based and behavior-based contract. Nevertheless,

due to the importance of great quality of the delivered components and, as already mentioned, the demand for Just-in-Time delivery and Lean Production determines that outcome-based contract is the only acceptable solution. This is summarized in Table 6-5.

Factor	OEM-HARA	Current condition		Theoretical contract seen from the principal
		OEM	HARA	
Information to verify behavior		Outcome and Cost (High Information)		Behavior-Based
Risk Attitude		Less Averse	Averse	Behavior-Based
Desired Goal		Goal conflict		Outcome-Based
Programmability		Task not Programmable		Outcome-Based
Measure Outcome		Easy Measurable		Outcome-Based
Length of Relationship		Long Period		Behavior-Based
<b>Current Contract:</b> <i>Outcome-Based</i> <b>Theoretical Contract:</b> <i>Behavior/Outcome-Based</i>				

Table 6-5 - Identification of theoretical favored contract type in the OEM – HARA relation

### HARA Logistic agreement versus Odette's Guide to Logistic Agreement

Odette's International Logistics Committee has developed 'Logistical Best Practices' [31] for the European Automotive industry. A part of this is a standard framework to cover the logistical relationship which has proven to generate considerable savings of effort if followed [31]. The guideline identifies the various stages to go through and also the specific points the agreement should include.

HARA has developed their own logistic agreement for relation with suppliers. This agreement consists of 8 main sections with several subsections. In brief, this agreement includes many of the same statements as the Odette Guide but has some differences and misses out on some potentially important points. It is important to note that an agreement will be specific for each relation and some items do not necessarily need to be included in every agreement. This comparison will therefore involve HARA's logistic agreement framework and not a case specific one. Subsequent to the comparison suggested improvements will on the next page be presented.

Changes suggested for the Logistic Agreement:

- *Add a logistic chain layout* between customer, supplier and third party. Stock points may also be illustrated here. This way each party can see relative location in the supply chain and easier understand how they influence the chain as a whole (Supply Chain Orientation, section 3.2).
- *Procedures for changes in deliveries and quantities* which influence the logistic process and costs. Major changes should have a pre-decided procedure so that all involved parties will be informed in time.
- *Procedures for regulating deviations from commitment*. An agent might act in their own best and not always in the principal's interest, thus regulations for performing differently than agreed should be specified in advance.
- *Procedures for resolving disputes* concerning quantities and prices in the invoice/self-bill. Deviations in quantities and prices have proven to be a major concern for HARA and procedures should therefore be stated in the agreement to make this process easier and resource saving.
- *The Logistic Agreement should include a separate section concerning communication*. Communication is now only dealt with in the 'Delivery Scheduling' section, where communication mode is stated. This section could include communication parameters (messages and timing), which message standard to use and also what communication to use in the event of disruptions, quality problems or transport problems.

Employing these suggested improvements could reduce some of the problems occurred in the “Pikes Peak” supply chain and in general make a relation better able to face future problems.

## **6.4 Supply Chain Risk**

A risk evaluation is performed to identify potential failure, understand the likelihood that a failure will occur and consequences of the failure. Identifying the risks helps the company to reduce potential losses and be aware of losses before they occur. A risk evaluation is performed for the supply and demand in the 'Pikes Peak' case. The worksheet is dynamic and is build in order for HARA, if desired, to expand to other parts of this supply chain and other supply chains. This section will first explain the evaluation procedure and worksheets and then describe the evaluation performed for this supply chain.

### **6.4.1 Worksheet Description**

This section should be used in combination with the worksheets to receive full utilization. The risk evaluation workbook consist of four (4) worksheets; Chain Descriptions, Demand Risk, Supply Risk and Evaluation Results. The workbook is an assessment made by the author's greatly influenced by Cranfield University's Self-Assessment Workbook [39] The *Chain Description* sheet describes the supply chain in detail to get an overall view of the chain. The reference number here is the number that will be used in the other sheets as a reference to the analyzed chain. This worksheet will include all of HARA's supply chains if they decide to use this tool. Every chain will then have a reference number and a separate unique sheet for demand, supply and evaluation results.

The *Demand Risk* and *Supply Risk* sheets are divided into sections, where the typical risk elements are described and analyzed. Then for each risk, different mitigation measures are stated. These risk elements and mitigation measures can be different for every supply chain analyzed and should therefore be case specific. The mitigation measures should be within the four categories; option, reinforcement, diversification and warning systems explained earlier.

Each risk identified will be ranked based on exposure (A), and potential offset by mitigation measures (B). Each of these two rankings, A and B, are given scores after the significance, 0,1,2 for the exposure and 2,1,0 for present mitigation and are multiplied to give the overall risk rating; thus a significant risk with no mitigation is given the score of 4 ( $2 * 2$ ). Each potential risk that is given a score of 1, or higher, will automatically be



transferred to the evaluation result sheet. The risk can in this sheet be explained and the desired actions and responsible department/employee can be stated accordingly.

When completed, the risk evaluation workbook will provide an analysis of the vulnerabilities in the company's supply chain and give a list with areas of priority concern, appropriate actions and responsibilities stated. This will generate an initial sketch of where the company should focus their risk management and resources in their supply chain. It should be noted that this risk evaluation, in most cases, provides uncertainties that should be investigated in more detail, but it is a valuable tool for detection of weaknesses and risk potential in the supply chain.

### **6.4.2 Risk Analysis**

The risk evaluation performed in this project handles first the relationship HARA has with its customer (OEM), where HARA acts as the agent, and then the relationship HARA has with its new supplier, Kirchhoff in Poland. Risk elements concerning the transportation are also regarded in the supply-analysis. The risk analysis is based on information from interviews, previous supply chain cases, contractual aspects, theoretical principles and numerical information. This evaluation summary will in great aspect refer to the evaluation worksheets. Hence, for a deeper understanding please refer to the appendix.

#### **6.4.2.1 Demand**

The Demand aspect concerns the relationship between the customer, OEM and HARA and is handled in the *Demand worksheet*. A list of typical risks are listed and analyzed for this specific supply chain. Case specific risk elements as 'distance to customer' and 'customer power position' is investigated. Together with: general demand risks as 'lead times', 'swing in demand' and 'new product introduction'. The mitigation measures include inventory cover, collaboration with customer, forecasting process, customer investments and strategically/contractual aspects. In this case the VMI consignment warehouse (Schnellecke) is seen as a mitigation measure more than another source of risk. This can be questioned since HARA is responsible but without control for what

Schnellecke does. However, since Schnellecke has a close relationship and collaboration with OEM and the fact that Schnellecke has been chosen by OEM, the risk element here has been neglected and Schnellecke is instead considered as a tool for risk mitigation.

All risk elements in *demand* achieves an overall rating (A\*B) of '0', denoting that there is no *imminent* risk that needs action. However, this does not mean that there is no risk in the OEM – HARA relationship. A closer look at the analysis reveals that 5 out of 9 possible risk elements (A) have been given the ranking “some” or “significant” risk. This implies that great risk aspects exist in this relationship, but are well limited by the mitigation measures (B). In fact, only one risk has ‘some’ mitigation, while the others have ‘significant’ risk mitigation. The risk elements in this relationship are therefore well taken care of and can be explained mainly by the close collaboration HARA has with OEM and that a consignment warehouse is situated close to the customer to fulfill the customer’s desires. In retrospect, considering Network theory, openness and mutual trust, such as the collaboration and long lasting relationship HARA has with OEM, is important to generate a best result as possible for the network as a whole.

#### **6.4.2.2 Supply**

In the risk analyze of the ‘supply’ part of the supply chain the focus is on the supplier, Kirchhoff, and on the transportation from HARA, Raufoss to Schnellecke, Bratislava. Kirchhoff has never been employed as a supplier to HARA before and is competing with HARA in some markets, which increases the possibility of an agent acting in their own interest.

As in the ‘demand’ evaluation, typical risk elements are listed and analyzed. These risks are both case specific and general supply specific in order to include all possible risk elements. The mitigation measures include; material inventory coverage (both at supplier and at the consignment warehouse), supplier contingency plan, process integration, contractual and quality control.

The transportation scores ‘0’ overall (A\*B) for all typical risks evaluated and it is just the customs that potentially can lead to implications. This implies that there is no risks

present in the transportation solution for this supply chain that needs special attention. Backup transportation route exists and the HARA – Multisped relation has a long flawless history, this combined with the safety stock minimizes the risk. This does not however mean that it will be flawless and stable forever, as mentioned in network theory, relations are constantly moving and changing and the risk threat should therefore be evaluated regularly. According to Principal-Agency theory, there is always a risk that, in a principal–agent relationship, one can witness *moral hazard* and an agent behaving in their own interest, especially if adverse events occur. This however, can be minimized by the contractual agreements as earlier discussed.

The relationship with the supplier, Kirchhoff has in contrast some aspects that need attention with respect to the evaluation performed. First of all, the supply of steel brackets is only covered by a single supplier, Kirchhoff. In addition, the brackets are designed and invested in by the supplier and HARA together, and are produced by tailor made tools (*asset specificity*) making it time and cost consuming for another supplier to take over the supply. Steps to minimize this risk can be to map one or two other suppliers that are in geographical proximity to existing supplier and Schnellecke. It is important that these also have available capacity to take over the production on a reasonably short notice.

Relying on one supplier enhances the importance of this supplier's financial situation. If the supplier runs into financial difficulties/distress, and can not fulfill their contract, HARA's delivery of bumpers will be affected after the safety stock has run out. Therefore, HARA and Audi have decided that, if an event like this occurs, they will support the supplier financially in order for them to maintain production until a new supplier is ready. This emergency plan can be very costly and is obviously undesired, and can also be avoided if the supplier's financial situation is investigated pre-contractual and monitored regularly.

There is no evidence to suggest that this has investigated other than the fact that the supplier is ISO-certified. Our investigation however, can reveal that Kirchhoff Automotives turnover has increased by 15 % and 20 % the last two years and they have

employed 25 % more people in the last 4 years. The Kirchhoff Group had, in 2005, an increase in turnover by 14 %. The Kirchhoff plant in Mielec, Poland, has increased 4 times its own size since 1999 and has recently bought new neighboring sites to further expand ([www.kirchhoff-gruppe.de](http://www.kirchhoff-gruppe.de)). It has not been possible to reveal the supplier's profit, but large investments in size and employees the last years indicate no financial difficulties. This should, however, be monitored regularly.

Another source of risk is the different languages. Kirchhoff is a German owned company that tends to use Polish and German as working languages. At HARA Norwegian and English are the working languages. This difference has resulted in difficulties in the agreement phase and for the daily information flow. Since German is mastered by some of HARA's employees, it is suggested that this is to be used as the business language between these two parties.

Trusting a new supplier with inadequate information can be difficult. Investigation shows signs of an internally divided view on the supplier and that not enough information has been exchanged and distributed. Thus, an information document regarding the supplier, including financial and future aspects, should be generated and distributed to all involved departments at HARA.

Another important aspect is the quality of the products delivered from the supplier. There have, as of April '06, only been some problems discovered with the coating of the brackets. This will, however, be improved this spring and should be adequate by the end of May. The steel and welding quality has so far been satisfactory and is at all times controlled towards the standard set by HARA at the Schnellecke assembly.

As a conclusion of the risk analysis done, it can be said that the supply chain seems to be working well and has several mitigation measures that prevent difficulties and problems in place. There do, however, exist some risk aspects that should be kept in mind and monitored regularly as stated earlier. The risk concerning the new supplier can to some extent said to be exaggerated. There is no evidence to imply that this supplier is in

financial difficulties or has quality problems, except for the coating issues. On the other hand, this supplier is a competitor in some areas and is therefore likely to, in an adverse situation, act in their own interest. This can, nevertheless, referring to the Principal-Agency theory's 'goal conflict', be avoided by the use of an outcome-based contract, which is in accordance with the present contract type.

## 7 Results & Conclusions

The performed research has carefully considered the requirements, development and improvement of HARA's 'Pikes Peak' supply chain and concluding remarks on the performed research will be presented in this section by answering the previously defined research objectives.

*√ Map, describe and assess current flows in the supply chain of material, information and financial transactions and suggest areas of improvement.*

The performed research has provided documentation in form of a Business Process Map, however, more accurately coined a Project Process Map, of the current supply chain solution. The Project Process Map is mapped in a way that will identify and define processes to illuminate and reveal issues throughout the supply chain. It will also increase the task programmability of a VMI relationship. The current structure is assessed and determined to be physically designed in working fashion – utilizing external providers of services and production is supported by theory and has increased HARA's competitiveness in an increasingly growing competitive market. It is evident, however, that the current structure has, if not flaws then, improvement potentials that would increase the efficiency of the supply chain.

Management of the VMI consignment stock has not provided all the theoretical benefits it is perceived to provide. It is in the authors' conviction that this is a consequence of inadequate information management. Better information sharing concerning external inventory management at the VMI consignment stock would mitigate present fluctuations in the inventory levels but, maybe more importantly, also form a foundation for negotiations with the OEM when necessary. RFID technology is perceived to have a positive effect on this area, helping in monitoring the VMI consignment stock inventory levels.

The current SAP solution regards shipped products from HARA as received at Schnellecke. This information management may increase the inventory level deviations and prove unfavorable if products were compromised during transportation. Neither is there any evidence of information sharing whenever a product is scrapped at the consignment stock. A new inventory record in SAP is suggested to handle this.

√ *Assess project development guidelines and performance with respect to the logistics.*

An assessment of HARA's project development guideline, the LPSR, has been performed and is determined to be just about adequate for designing a successful supply chain. There is, however, evidence of the LPSR being employed quite successfully but not in the 'Pikes Peak' project. The main concern in this case is the *use* of the LPSR. It has not been used during the design of the supply chain which has proved unfortunate for the performance of the supply chain today. The logistic development has been performed in an unstructured manner and problems have occurred consequently.

The LPSR is assessed to exist of an insufficient number of processes and at the same time the process descriptions lack profundity. For instance, The Supply Chain Council and Odette suggest that there should be additional process descriptions and in a more thorough manner. Other SCM tools are therefore proposed to have a positive effect on the design of future supply chains, with Odette's MMOG/LE as the suggested appropriate tool for the logistics part.

√ *Can relevant theory and contractual aspects predict the supply chain partners' behavior and suggest an appropriate contract type?*

The contractual agreements HARA has entered with its partners are analyzed against the propositions suggested in Principal-Agency theory. Each proposition has been used to find the theoretical appropriate contract type, outcome or behavior-based, based on the supply chain partners' expected behavior. Goal conflict, power structure and information

asymmetry are discussed and the theoretically suggested contract types are found to be in accordance with the existing contracts for all relations in this case.

Even though the theoretical justification of the OEM-HARA contract lies somewhere between an outcome-based and a behavior-based contract, the importance of great quality components and the demand for Just-in-Time delivery and Lean Production suggests an outcome-based contract. The importance of a well contracted agreement to secure the principals interests is discussed, especially for the HARA-Schnellecke relation, where the principal not necessary hold the *power position*. HARA's logistic agreements have been compared with Odette's "Guide to Logistics Agreement" developed for the European Automotive industry and is found to be inadequate in some areas. This mostly concerns communication and routines for disputes. Some changes, also based on experiences from the 'Pikes Peak' case, are therefore suggested.

### **Project evaluation**

HARA experience an increasing demand for VMI-solutions from OEMs. Hence, parts of the research project can therefore be transferable. The Project Process Map can be used as a guideline for development and documentation of future supply chains. The LPSR, with suggested improvements, can be used for development of new VMI-programs and the risk assessment is generated dynamically to fit all of HARA's supply chains. Conceivably, employing the previously used MMOG/LE may be a way of improving the project development and reporting. The contractual agreements are found to be in accordance with the theoretical suggested contract types and can, with only minor improvements, also be employed for future relations.

The research project is an in-depth case study of the processes in the 'Pikes Peak' supply chain and the authors have put great emphasis on providing details as accurate as possible and to maintain neutral. However, the empirical information is only gathered from two sources and may therefore be biased to some extent.



## 8 Abbreviations

3PL	Third-Party Logistics
4PL	Fourth-Party Logistics
AIAG	Automotive Industry Action Group
B2B	Business-to-Business
BOM	Bill of Material
BPM	Business Process Map
EDI	Electronic Data Interchange
ERP	Enterprise Resource Planning
ESP	External Service Provider
HARA	Hydro Aluminium Structures Raufoss
ISO	International Organization of Standardization
IT	Information Technology
KPI	Key Performance Indicator
LPSR	Logistic Project Status Report
MMOG/LE	Materials Management Operations Guideline and Logistic Evaluation
MPS	Master Production Schedule
MRP	Material Resource Planning
OEM	Original Equipment Manufacturer
POS	Point of Sale
PPM	Project Process Map
RFID	Radio Frequency Identification
SCM	Supply Chain Management
SCO	Supply Chain Orientation
SCOR (-model)	Supply Chain Council Reference (Model)
UHF	Ultra High Frequency
VAL	Value Added Logistics
VAT	Value Added Tax
VMI	Vendor Managed Inventory
VW	Volkswagen

## 9 References

### Books, Journals and Reports

- [1] Agrell, P. and A. Norrman, *Understanding Supply Chain Risk Sharing: A Three-tier Principal-Agent Approach*. In *16th Annual Conference for Nordic Researchers in Logistics*. 2004. Linköping, Sweden.
- [2] Aubert, B.A. and R. Weber, *Transaction Cost Theory, The Resource-Based View, and Information Technology Sourcing Decisions: A Re-Examination of Lacity et al.'s Findings*. 2001, École des Hautes Études Commerciales de Montréal.
- [3] Aviv, Y. and A. Federgruen, *The operational benefits of information sharing and vendor managed inventory (VMI) programs*. 1998, John M. Olin School of Business, Washington University: St. Louis, MO.
- [4] Barney, J.B., *Firm Resources and Sustained Competitive Advantage*. *Journal of Management*, 1991.
- [5] Betts, M., *Manage My Inventory Or Else!* Computerworld, 1994. **28**.
- [6] Boone, T. and R. Ganeshan, *New directions in supply-chain management: technology, strategy, and implementation*. 2002, New York: Amacom. XI, 387 s.
- [7] Churchill, G.A. and D. Iacobucci, *Marketing Research, Methodological Foundations*. 9 ed. 2005: Thomson Corporation.
- [8] Clark, T. and J. Hammond, *Reengineering Channel Reordering Processes to Improve Total Supply-Chain Performance*. *Production and Operations Management*, 1997. **6**.
- [9] Clarke, R., *Electronic Data Interchange (EDI): An Introduction*. *Business Credit*, 2001. **23**.
- [10] Copacino, W.C., *How to Get with the Program*. *Traffic Management*, 1993. **32**.
- [11] Deleris, L.A., F. Erhun, and M.E. Patè-Cornell, *Quantitative Risk Assessment of Supply Chain Performance*, in *Management Science and Engineering*. 2004, Stanford University: Stanford.
- [12] Disney, S.M. and D.R. Towill, *Bullwhip Reduction in Supply Chains - The Impact of VMI*. *International Journal of Operations Management*, 2003. **23**(6).
- [13] Eisenhardt, K.M., *Agency Theory: An Assessment and Review*. *Academy of Management Review*, 1989. **14**(1).
- [14] Fjeldstad, O.D. and C.B. Stabell, *Configuring Value For Competitive Advantage: On Chains, Shops, and Networks*. *Strategic Management Journal*, 1998. **19**.
- [15] Gadde, L.-E. and H. Håkansson, *Supply Network Strategies*. 2001: John Wiley & Sons.
- [16] Giunipero, L.C. and R.A. Eltantawy, *Securing the upstream Supply Chain: a risk management approach*, in *Department of Marketing, College of Business*. 2004, Florida State University, Tallahassee: Florida, USA.
- [17] Håkansson, H., *Corporate Technological Behaviour, Co-operation and Networks*. 1989: Routledge.
- [18] Halldorsson, A., et al., *Designing and Managing Supply Chains: Theoretical Foundation and Application*. *Proceeding of NOFOMA*, 2004.
- [19] Harrington, L., *Logistics Assets: Should You Own or Manage?* *Transportation &*

- Distribution, 1996. **37**.
- [20] Henningsson, E. and T. Lindèn, *Vendor Managed Inventory: Enlightening Benefits and Negative Effects of VMI for Ikea and its Suppliers*, in *Department of Business Administration and Social Sciences*. 2005, Luleå University of Technology: Luleå.
- [21] Hugos, M., *Essentials of supply chain management*. Essentials series. 2003, Hoboken, N.J.: Wiley. X, 254 s.
- [22] Johannessen, A., L. Kristoffersen, and P.A. Tufte, *Forskningsmetode, for økonomisk-administrative fag*. 2004: Abstrakt Forlag.
- [23] Kara, S., *Production Planning and Control (Course Material for MANF.9472)*. 2005, University of New South Wales, Sydney.
- [24] Kayis, B., *Managing Manufacturing Operations*. 2005: University of New South Wales.
- [25] Knolmayer, G., P. Mertens, and A. Zeier, *Supply Chain Management Based on SAP Systems*. 2002: Springer-Verlag Berlin - Heidelberg.
- [26] Lapide, L., *New Development in Business Forecasting. VMI can be good for Your Forecasting Health*. The Journal of Business Forecasting, 2002. **20**(4).
- [27] Lee, H.L., K.C. So, and C.S. Tang, *The Value of Information Sharing in a Two-Level Supply Chain*, in *Working paper, Department of Industrial Engineering and Engineering Management*. 1999, Stanford University, Stanford, CA.
- [29] Logan, M.S., *Using Agency Theory to Design Successful Outsourcing Relationships*. The international Journal of Logistics Management, 2000. **11**(2).
- [30] Mata, J.F., W.L. Fuerst, and J.B. Barney, *Information Technology and Sustained Competitive Advantage: A Resource-Based Analysis*. MIS Quarterly, 1995.
- [31] Mentzer, J.T., et al., *Defining Supply Chain Management*. Journal of Business Logistics, 2001. **22**(2).
- [32] ODETTE, *Guide to Logistics Agreement*. 2000, (Odette International - Organisation for Data Exchange by Teletransmission in Europe.)
- [33] Parks, L., *CRP Investments Pays Off in Many Ways*. Drugs Store News, 1999. **21**.
- [34] Poppendieck, M., *Principles of Lean Thinking. OOPSLA Onward!*, 2002.
- [35] Porter, M.E., *Competitive advantage: creating and sustaining superior performance*. 1985, New York: Free Press. Xviii, 557 s.
- [36] Simchi-Levi, D., P. Kaminsky, and E. Simchi-Levi, *Designing & Managing the Supply Chain*. 2000: McGraw Hill, Irwin.
- [37] Simchi-Levi, D., P. Kaminsky, and E. Simchi-Levi, *Designing & Managing the Supply Chain*. 2 ed. 2003: McGraw Hill, Irwin.
- [38] Skjott-Larsen, T., *Supply Chain Management: A New Challenge for Researchers and Managers in Logistics*. The International Journal of Logistics Management, 1999. **10**(2).
- [39] Skjott-Larsen, T., C. Thernøe, and C. Andersen, *Supply Chain Collaboration*. International Journal of Physical distribution & Logistics Management, 2003. **33**(6).
- [40] University, C., *Understanding Supply Chain Risk: A Self-Assessment Workbook*. 2003: Cranfield University, School of Management, Centre for Logistics and Supply Chain Management, Bedford, UK.
- [41] Waller, M., M.E. Johnson, and T. Davis, *Vendor Managed Inventory in the retail*

- supply chain*. Journal of Business Logistics, 1999. **20**(1).
- [42] Williamson, O., *The Economic Institutions of Capitalism*. Free Press, 1985.
- [43] Yin, R.K., *Case Study Research, Design and Methods*. 3 ed. Vol. 5. 2002: SAGE Publications.
- [44] Zylstra, K.D., *Lean Distribution*. 2006: John Wiley & Sons, Inc.

## Websites

- Audi – [www.audi.com](http://www.audi.com) (Audi)
- Hydro – [www.hydro.com](http://www.hydro.com) (Hydro / HARA)
- IDzone – [www.idzone.dk](http://www.idzone.dk) (RFID)
- Inventory Ops – [www.inventoryops.com](http://www.inventoryops.com) (SCM and SC concepts)
- Kirchhoff – [www.kirchhoff.pl](http://www.kirchhoff.pl) (Kirchhoff)
- Multisped – [www.multisped.no](http://www.multisped.no) (Multisped)
- Odette – [www.odette.org](http://www.odette.org) (Odette and MMOG/LE)
- RFID Journal – [www.rfidjournal.com](http://www.rfidjournal.com) (RFID)
- SAP – [www.sap.com](http://www.sap.com) (SAP)
- Schnellecke – [www.schnellecke.de](http://www.schnellecke.de) (Schnellecke)
- Supply Chain Council – [www.supply-chain.org](http://www.supply-chain.org) (SCOR)
- Symbol Technologies Corporate – [www.symbol.com](http://www.symbol.com) (RFID)
- Syracuse University [Jatin Bhagnari] – <http://web.syr.edu/~jbhagnar> (ERP)
- Technology Evaluation – [www.tecwhitepapers.com](http://www.tecwhitepapers.com) (MMOG/LE)
- Wikipedia – [www.wikipedia.com](http://www.wikipedia.com) (various)

## 10 Appendix

### Interview Guides

### Risk Evaluation Sheets

**Electronically attached documents include:**

**Project Process Map (html)**

**Risk evaluation sheets (excel)**

## Interview Guides

The initial interviews of key personnel follow first and then interview guide for the specific processes at HARA and Multisped.

### **Interview: Håkon Skjenken, *Project manager***

#### **Initial questions:**

- 1) What is your responsibility in project development?
- 2) Who do you report to? Is there any committee or management that oversight you?
- 3) Which departments are involved in a project team (product design, logistic, purchase etc) and when do they get involved in a project?
- 4) What are the different department's responsibilities?
- 5) Any general and project specific objectives and goals you follow? Are these measurable? (Milestones/KPI)

#### **Questions specific for the Pikes Pike project:**

- 6) Can you explain your role in the "Pikes Peak" project?
- 7) Can you explain the steps you followed when you first got this project?
- 8) Was a project plan set up and can we get a copy of this?
- 9) What are the report procedures from the team leaders and how often did you have follow up and status meetings?
- 10) How do you understand the customer, here OEM (Audi), regarding a power structure?
- 11) Did you have any initial investments taking on the deal with Audi?
- 12) Do you have any long-range continuous improvements/investments plans for this project?
- 13) What is the time frame for this project?
- 14) How does HARA look at the parts from Kirchoff? How important are these? Are they considered as parts, subassemblies or major components?
- 15) What are the reason for the decision of using steel brackets and not aluminum?
- 16) Have you learned anything from this case that you feel can be done better for future projects?

#### **Questions regarding HARA as an agent:**

- 17) Desired contract type with OEM?
- 18) How and does OEM measure HARA's behavior and outcome?
- 19) How does HARA look at the risk involved in this relationship with OEM?
- 20) Has any goal conflict been noticeable?
- 21) Does HARA feel that reveal of some information will hurt them concerning this relationship? (Cost/Capacity/Investments) (Referred to a 'Open-book')
- 22) Any additional information HARA would like to receive from the principal?

### **Interview: Roy Jacobsen, *Head of Logistics***

#### **Initial questions:**

- 1) What is your responsibility in the logistic department?
- 2) How many VMI/consignment warehouses does HARA currently employ?

3) Can you comment on your experiences with these?

**Questions specific for the Pikes Pike project:**

- 4) What has been your role in the 'Pikes Peak' project?
- 5) Can you tell us the procedure that you followed when the logistic department was involved in this project?
- 6) Do you feel that the logistic department is involved in the project at the most suitable stage or could collaborative planning/design in an earlier stage be of value? (Concurrent engineering)
- 7) What are the main objectives when designing a new supply chain like the Pikes Peak case?
- 8) Did this project follow the "Logistic project status report (LPSR)"? If no, why not?

**Questions regarding HARA as an agent:**

- 9) What is the desired contract type with OEM?
- 10) How and does OEM measure HARA's behavior and outcome?
- 11) How does HARA look at the risk involved in this relationship with OEM?
- 12) Has any goal conflict been noticeable?
- 13) Does HARA feel that reveal of some information will hurt them concerning this relationship? (Cost/Capacity/Investments) (Referred to a 'Open-book')
- 14) Any additional information HARA would like to receive from the principal?

**Questions regarding HARA as a principal:** (Schnellecke/Kirchoff/Multisped as agents)

- 15) Does HARA have any information/verification of the agent's behavior and/or outcome?
- 16) Can the agent behavior be easily predicted in advance or is the behavior highly uncertain? (This is before disclosure of any contract.)
- 17) Any sign of agent moral hazard or adverse selection?
- 18) How does HARA look at the risk they are facing in the relationship with these agents?
- 19) Are there any risks that HARA feel is worth taking?
- 20) What is the desired length of the relationship from HARA's perspective?
- 21) Has HARA made any initial investments with the agents?

**Interview: Sjur Hopland, Purchasing department**

**Questions specific for the Pikes Pike project:**

- 1) What has been your role in the 'Pikes Peak' project?
- 2) Can you explain what procedures/guidelines you followed in this project?
- 3) OEM decided that you had to use Schnellecke as the 3pl. What has been your involvement in this agreement?
- 4) What aspects were considered when you choose Kirchhoff as the supplier of the steel brackets? (Cost, location, risk, relationship history)
- 5) What previous relations do you have with Kirchoff?

**Questions regarding HARA as a principal:** (Schnellecke/Kirchoff/Multisped as agents)

- 6) Does HARA have any information/verification of the agent's behavior and/or outcome?
- 7) Can the agent behavior be easily predicted in advance or is the behavior highly uncertain? (This is before disclosure of any contract.)
- 8) Any sign of agent moral hazard or adverse selection?
- 9) How does HARA look at the risk they are facing in the relationship with these agents?
- 10) Are there any risks that HARA feel is worth taking?
- 11) What is the desired length of the relationship from HARA's perspective?
- 12) Has HARA made any initial investments with the agents?

**Interview: Geir Stangjordet, Logistic Consultant**

**Initial questions:**

- 1) What is your responsibility in the logistic department?
- 2) How many VMI/consignment warehouses does HARA currently employ?
- 3) Can you comment on your experiences with these?

**Questions specific for the Pikes Pike project:**

- 4) What has been your role in the 'Pikes Peak' project?
- 5) Can you tell us the procedure that you followed when the logistic department was involved in this project?
- 6) Do you feel that the logistic department is involved in the project at the most suitable stage or could collaborative planning/design in an earlier stage be of value? (Concurrent engineering)
- 7) What are the main objectives when designing a new supply chain like the Pikes Peak case?
- 8) Did this project follow the "Logistic project status report (LPSR)"? If no, why not?
- 9) Can you explain the basic structure of the chain? Flow of material, information and money?
- 10) Do you have any long-range continuous improvements/investments plans?
- 11) Are you able to fully utilize and take advantage of the benefits from this consignment stock agreement?

**Questions regarding HARA as an agent:**

- 12) What is the desired contract type with OEM?
- 13) How and does OEM measure HARA's behavior and outcome?
- 14) How does HARA look at the risk involved in this relationship with OEM?
- 15) Has any goal conflict been noticeable?
- 16) Does HARA feel that reveal of some information will hurt them concerning this relationship? (Cost/Capacity/Investments) (Referred to a 'Open-book')
- 17) Any additional information HARA would like to receive from the principal?
- 18) What are the current service levels you have to maintain imposed by Audi?

**Questions regarding HARA as a principal:** (Schnellecke/Kirchoff/Multisped as agents)

- 19) Does HARA have any information/verification of the agent's behavior and/or outcome?
- 20) Can the agent behavior be easily predicted in advance or is the behavior highly uncertain? (This is before disclosure of any contract.)
- 21) Any sign of agent moral hazard or adverse selection?
- 22) How does HARA look at the risk they are facing in the relationship with these agents?
- 23) Are there any risks that HARA feel is worth taking?
- 24) Have you employed any 'safeguards' in these relationships?
- 25) What is the desired length of the relationship from HARA's perspective?
- 26) Has HARA made any initial investments with the agents?

**Interview Svenn-Erik Danielsen,** Distribution Coordinator, Multisped

**Initial questions:**

- 1) Can you explain Multisped's relationship and involvement with HARA?
- 2) What is your role in Multisped?
- 3) Who are Multisped's closest competitors and what are your main advantages?

**Questions specific for the Pikes Pike project:**

- 4) Did you have any initial investment and requirements for this particular case?
- 5) Can you explain Multisped's involvement and procedures for this case?
- 6) What kind of communication is used between HARA and Multisped?
- 7) Do you have any comments on how the agreement works today and any suggestions on improvement?
- 8) How does Multisped look at the risk involved in this relationship with HARA?
- 9) How and does HARA measure Multisped's outcome?
- 10) What is your desired contract type with HARA?
- 11) Any additional information Multisped would like to receive from HARA?
- 12) How does the payment procedure to HARA work?

**Questions regarding the processes:**

- 13) Are there any other deliveries on this route?
- 14) Who is responsible for loading/unloading and when is this scheduled?
- 15) What is the minimum quantity (batch) needed to make this transport beneficial?
- 16) How is the pick up of empty racks from Schnellecke working today?

**Interview guides: 2nd visit HARA and Multisped.**

These interviews are following up questions for the Business Process Map to get all the processes and activities right. The questions are divided in subsections for that particular process. At HARA these questions were asked to the people involved in the 'Pikes Peak' project, while at Multisped only to the person responsible for this delivery.



## Interview: HARA - Process description

Receive Forecast
What data is exchanged?
What happens when HARA receives the forecast/prognosis from Audi?
Who manages this part?
To what degree is this integrated in SAP, and how?
Is the forecast altered before sent to Kirchoff?
MPS
What figures goes into the planning of the MPS?
Who manages this part?
Are 'Inventory Level' and 'Forecast' the only inputs in this process?
Is 'Delivery Plan' the only output of this process?
To what degree is this integrated into SAP, and how?
Delivery Plan
Is 'MPS' the only input to this process?
Are 'Transport Order' and 'Production Plan' the outputs of this process?
Who manages this part?
To what degree is this integrated into SAP, and how?
Transport Order
Is this only a process of sending the order to Multisped, or is there something more?
How is the communication with Multisped performed?
Does this trigger invoicing from Multisped?
Production Plan
This process triggers the production execution; when, how?
Production Execution

Do you set batch sizes or production batches exact after MPS/forecast?
<b>Replenish Stock</b>
Are the bumper production considered make-to-stock or make-to-order?
Are the bumpers directly loaded? –not to warehouse but to containers/racks.
How is the inventory level at this stage controlled/monitored/reported?
What is the desired inventory level?
Could RFID-technology be a future solution to control the levels, directly integrated with SAP and production plan/ delivery plan?
<b>Receive Self-bill</b>
Who manages this stage?
How often?
Communicated through?
<b>Check Quantity and Price</b>
Who manages this stage?
Number of deviations?
Exact procedures for solving these problems
<b>Documentation of Deviation (Audi)</b>
What are the deviation routines?
<b>Receive Invoice</b>
Who manages this stage?
What are the procedures?
What is this communicated through?
<b>Check Quantity (Schnellecke &amp; Kirchoff)</b>
Who manages this stage?
What is checked?
<b>Documentation of Deviation</b>

Routines?
<b>Offloading of Empty Containers</b>
Is there a solution for this today?
How is this working in other projects?
Is this a part of the contract with Multisped?
Bills and invoices are paid by Hydro Slovakia. May we get a complete introduction to what and how this company is utilized and what tasks it performs, how it performs them, and why this is necessary?

### **Interview: Multisped – Process description**

<b>Organization of Transport</b>
How is this organized?
Reaction time?
Does this trigger the invoice?
<b>Loading</b>
Who loads?
Batches?
When is it loaded? (time, time)
Loading lead time?
<b>Transport</b>
Transport route?
Is this optimal?
Other possibilities?
<b>Custom clearance</b>
Where?
Implications?
Lead time?

An Assessment of Hydro Aluminium Structures' Supply Chain to Audi  
Requirements, Development & Improvements to an International Automotive Supply Chain

---

Problems?
What documents are needed?
Any experiences and problems with EU vs. non-EU countries?
<b>Transport</b>
Transport route?
Who unloads at Schnellecke?
Problems at Schnellecke?
Suggestions of improvement at Schnellecke?
<b>Loading of Empty Containers</b>
Is this implemented in 'Pikes Peak'?
How does this work in other projects?
Do you bring back racks/containers from other sites on the return?
<b>Transport</b>
Do you have other transportation projects returning to Norway?
Same transportation route back?
<b>Invoice based on shipments</b>
Is this the correct basis for invoice?
When is this sent to HARA?
Have you experienced any problems with this kind of billing?
Any other methods you would like to use / improvements?
Any comments on problems/improvements on the communications of invoicing?

## Risk Evaluation Sheets

SHEET #1 – Chain Description

SHEET #2 – Demand Risk

SHEET #3 – Supply Risk

SHEET #4 – Evaluation Result

Ref.No.	Description	Main Material	Frequency	Supply chains		Warehouse	Secondary	Customer	
				Plant of supply	Primary distribution				Additional Material Supply
1	Produce and deliver bumper for Audi Q7	Rear aluminum bumper	Weekly	HARA Raufoss	Truck arranged by Multisped	Steel brackets produced at Kirchhoff, Poland	Schnellecke, Bratislava. Value adding assembly	Truck arranged by Schnellecke	VW Bratislava
2									
3									
4									
5									
6									
7									
8									
'									
'									
n									
n+1									



Risk Analysis

1  
Supply

STATUS		A Risk Exposure	Mitigation Measures					B Risk Offset	Risk Rating
Description	Analysis	Ranking 0=none, 1=some, 2=significant	Material Inventory cover	Supplier contingency plan	Process Integration	Contractual	Quality control	Ranking 0=significant, 1=some, 2=none	Overall Risk= A*B
Identify if the chain is dependant on one specialist supplier where failure to supply could disrupt output	Key components delivered from one dominant supplier. Key dependency; No delivery = No output	2	1 + 1 week	No backup supplier exist	Investment in supplier tools	Car model life time contract		1	2
Identify if supplier/s are in potential financial difficulties that could interrupt delivery	Supplier ISO certified. No proof of financial difficulties but some concern here	1	1 + 1 week	AUDI and HARA will support supplier temporary	Investment in supplier tools	Car model life time contract		1	1
Establish if key supplier/s have a record of poor quality or if this is a risk that might arise	Quality issues concerning spray painting on brackets. Bracket quality been satisfying.	1	1 + 1 week		Investment in supplier tools	Car model life time contract	Control at Schnellecke up against Hydro standard	0	0
Establish if there are suppliers with poor delivery compliance and their dependency	All deliveries so far has been on time. (100 %)	0	1 + 1 week		Kirchhoff responsible for own deliveries	Car model life time contract	Daily Inventory Report from Schnellecke	0	0
Are there measures of performance with suppliers that can provide a basis for an improvement programme?	Outcome and Quality performance measured	0	1 + 1 week		Investment in supplier tools	Car model life time contract	Quality control at Schnellecke	1	0
Identify if the supplier has production capacity that could lead to inability to supply the quantities demanded	Capacity of 50 % increase in demand from forecasted	0	1 + 1 week	Increasing plant size 2006/2007	Investment in supplier tools	Car model life time contract	Quantity control at Schnellecke	0	0
Identify if differences in cultural and geographical aspects could lead to longer lead times or disruptions	Supplier closer to warehouse than focal firm. Language barriers have proven to be a source for problems	1	1 + 1 week		Investment in supplier tools	Car model life time contract		1	1
Identify relationship history with supplier	First time relationship with this supplier.	2	1 + 1 week		Investment in supplier tools	Car model life time contract	At Schnellecke	1	2
Identify if the chain is dependant on one supplier or if other backup alternatives are in place	One distribution supplier arranges the transport and can choose different alternatives each week	0	1 + 1 week		Long relationship history	3 years contract with distribution provider		0	0
Establish if there is a record of poor 'on time delivery' history	No record of poor 'on time delivery' history at all using MultiSped	0	1 + 1 week		Long relationship history	3 years contract with distribution provider		0	0
Establish if there have been problems and delays due to customs concern	Customs clearance at German border have been successful. Custom clearance at the Swedish border or in Slovakia have proven to be very time consuming	1	1 + 1 week	Customs at Swedish boarder and in Slovakia are available	Long relationship history	3 years contract with distribution provider		0	0

