

Cooperative RTS/CTS MAC with Relay Selection in Distributed Wireless Networks

Xin He and Frank Y. Li
Dept. of Information and Communication Technology, University of Agder (UiA)
N-4898 Grimstad, Norway
Email: {xin.he; frank.li}@uia.no

Abstract—This paper proposes a cooperative multiple access protocol based on the Distributed Coordination Function (DCF) Request-To-Send/Clear-To-Send (RTS/CTS) scheme for distributed wireless networks. It answers three key questions concerning cooperation from the network perspective, namely when to cooperate, whom to cooperate with and how to protect cooperative transmissions. According to our protocol, the cooperation is initiated only if the direct transmission fails. An optimal relay node is selected in a distributed manner according to instantaneous relay channel conditions without prior information or extra signaling among relay candidates in the network. An additional three-way handshake is introduced to protect cooperative retransmissions against the hidden terminal problem. Both analysis and simulation results show that significant improvement in throughput and packet delivery rate can be achieved using the proposed cooperative protocol.

Keywords: Cooperative MAC, relay selection, distributed wireless networks.

I. INTRODUCTION

Recently, cooperative communications have attracted more and more attention due to its ability to mitigate fading in wireless networks. In cooperative communications, relays are assigned to help a source node to deliver its information to its destination node. Spatial diversity is achieved in this way, while the difficulties of installing multiple antennas on small wireless terminals are avoided. The studies from the physical layer have shown significant gains from cooperative diversity in terms of reliability, coverage range and energy efficiency [1]~ [3].

When cooperative diversity is utilized from the Medium Access Control (MAC) layer in distributed wireless networks, three key issues need to be addressed, namely when to cooperate, whom to cooperate with and how to protect cooperative transmissions. Firstly, since wireless channels vary with time, a source node may not always need help from a relay node. Therefore it is more sensible that cooperation is only initiated when it is necessary and beneficial. Secondly, one or more appropriate relay nodes need to be selected among multiple potential helpers in the network. The relay selection scheme becomes a real challenge in a distributed network because there is no central controller and collisions might happen when several potential relays are contending for channel access. Lastly, the MAC protocol should be carefully designed to protect all transmission sequences from possible collisions within the network.

Most of the existing cooperative MAC protocols in the literature have not covered all the aforementioned three issues. Many of them have the assumption of preselected relay node without considering extra overhead of proactive relay selection schemes in their performance evaluation [4]~ [7]. Only a few MAC protocols have relatively complete design for cooperative transmission in distributed wireless networks, and their limitations are discussed in the following.

CoopMAC [8] is proposed to mitigate the throughput bottleneck problem caused by low data rate nodes by employing high data rate stations forwarding the traffic from low data rate stations. A Helper ready To Send (HTS) control frame is introduced to the RTS/CTS scheme to protect the whole transmission sequences. However, the helper is selected from a so called CoopTable based on observations of historical transmissions, which hence might not be updated instantaneously. Besides, the establishment and maintenance of the CoopTable at each station for each potential destination requires extra memory and introduces significant complexity to the system.

The Persistent Relay Carrier Sensing Multiple Access (PRCSMA) protocol [9] applies distributed cooperative automatic retransmission to wireless networks. In the PRCSMA scheme, all stations are invited to become active relays as long as they meet certain relay selection criteria. Multiple relays try to get access to the channel in the cooperative phase according to the DCF protocol [10]. However, the resulted long defer time and random backoff time at each relay lead to low bandwidth efficiency.

In the cooperative MAC proposed in [11], cooperation is initiated when the potential cooperative link can satisfy the targeted data rate which the direct link cannot satisfy. The link capacity is estimated using instantaneous Signal-to-Noise Ratio (SNR). The estimation requires extra calculation complexity and is not precise enough. In its relay selection phase, an extra busy tone channel is introduced to reduce collisions among multiple contending relay candidates in the relay selection phase.

Similarly, [12] uses triple busy tone to protect ongoing transmissions and to reduce collisions among potential helpers. Its relay selection scheme is based on the upper bound performance of hard-decision Viterbi decoding, which introduces too high calculation complexity for practical use.

In this paper, a cooperative MAC protocol based on the DCF RTS/CTS scheme is proposed, in which the three afore-

mentioned issues concerning cooperative transmission at the MAC layer are handled efficiently with minimum cost of the resource in the network. Firstly, in order to reduce the overhead of relay nodes, only a single relay node is selected for cooperation since it is proved that one optimal relay is sufficient to achieve full cooperative diversity with appropriate relay selection scheme [13]. In addition, unnecessary occupation of channel and waste of system energy are avoided by the application of automatic cooperative retransmission request, which means cooperative transmission is only initiated when the direct transmission fails. Secondly, inspired by the idea of adapting the backoff time before transmission in [14], the optimal relay node is selected according to instantaneous relay channel conditions. In the meantime, the collision problem among multiple contending relays in the network is solved efficiently. Lastly, the cooperative transmission sequences are protected by an additional three-way handshake. Simulations are made to evaluate the throughput and reliability performance of the proposed cooperative scheme.

The rest of the paper is organized as follows. The system model for illustrating the proposed cooperative scheme is introduced in Sec. II. In Sec. III, the proposed cooperative RTS/CTS protocol is described in details. In Sec. IV, throughput and packet delivery rate performance is analyzed. Furthermore, simulation results are given in Sec. V, followed by the conclusions in Sec. VI.

II. SYSTEM MODEL

The network shown in Fig. 1 is taken as an example to illustrate how the proposed cooperative scheme works. The network consists of a source station, S , a destination station, D , and several other arbitrarily distributed potential helper nodes, R_1, R_2, \dots, R_n .

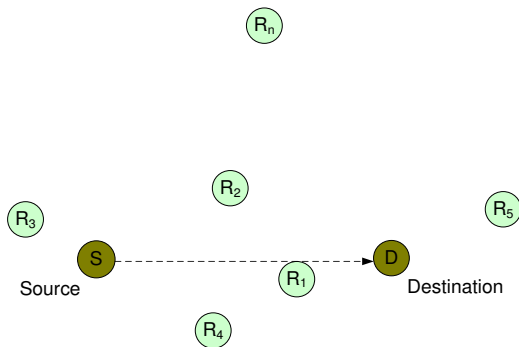

Fig. 1. System Model for Cooperative Transmission.

Each packet transmission starts from S , with the intended destination D . Other nodes in the network that can hear from both the source node and the destination node become relay candidates. The cooperative retransmission is only initiated when the direct transmission fails. The relay candidates will contend for channel access if they have correctly decoded the data packets they have captured from the direct link and the relay selection criterion is satisfied. An optimal relay node

will be automatically selected to forward the data packet to the destination according to our proposed scheme.

In the model, we assume the wireless channels to be strongly correlated in the time domain but independent in the spatial domain. That is to say, the direct link is highly temporally correlated and the time diversity is limited when Automatic-Repeat-Request (ARQ) is executed on the same channel; but the channels between S and D and the channels between each relay candidate and D are assumed to be independent of each other, hence the full spatial diversity can be achieved by data retransmission on another channel. The above assumptions are validated in experiments carried out with 802.11g systems in typical office environments [15]¹.

Furthermore, the proposed model can be extended to a multi-hop scenario in which the link between S and D (including the relays) takes the role as a new virtual single hop within a multi-hop route.

III. COOPERATIVE PROTOCOL DESCRIPTION

The proposed cooperative procedure consists of two phases: the direct transmission phase and the cooperative retransmission phase. The direct transmission sequences from source to destination in the first phase comply with the traditional DCF protocol. The second phase happens only if the transmission in the first phase fails. A distributed relay selection scheme is included in the second phase and an extra three-way handshaking is introduced to avoid collisions from the hidden terminal problem.

A. Direct Transmission Phase

As the first step, node S sends out its data packet to D according to the DCF RTS/CTS access scheme, as shown in Fig. 2.

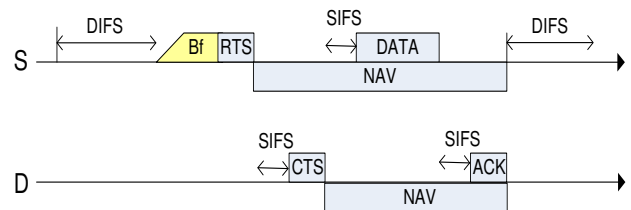

Fig. 2. Phase I: Direct Transmission.

The source node listens to the channel for a Distributed InterFrame Space (DIFS) before transmission. A random backoff scheme is carried out thereafter to avoid collisions. Two short RTS and CTS frames are exchanged before data frame transmission. When the destination node receives the data frame successfully, it returns an acknowledgment (ACK)

¹The experiments in [15] were set up with one sender and two receivers, which were placed close to each other, and the distance between the transmitter and the receivers was around 5 meters. The results have revealed two important observations: the channels exhibit strong time correlation for each receiver, while negligible correlation between the two receivers. Considering the reciprocal characteristic of the 802.11 wireless channels, the above observed results can be applied in our model with two transmitters and one receiver.

frame to the source node after a Short InterFrame Space (SIFS) interval.

The RTS and CTS frames carry information about the length of the current frame exchange. Any listening station can read this information and then update a Network Allocation Vector (NAV) field, which contains the time duration during which the channel remains busy. Therefore, when a station is hidden from either the transmitting or the receiving station, by detecting just one of the RTS/CTS frames it can suitably delay further transmission, and thus avoid possible collisions.

As shown in Fig. 2, the NAV value from the RTS frame is set to be the sum of 3 SIFS intervals, the CTS transmission time, the DATA transmission time and the ACK transmission time; the NAV value from the CTS frame is set to be the sum of 2 SIFS intervals, the DATA transmission and the ACK transmission time.

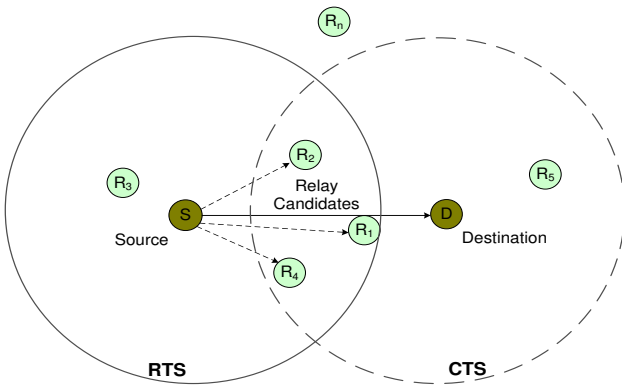

Fig. 3. Two-way Handshaking.

In addition to channel reservation for ongoing data transmissions, the RTS and CTS frames also perform important functions for later potential cooperative transmission. As shown in Fig. 3, the relay candidates that have received both the RTS frame and the CTS frame (i.e. R_1 , R_2 and R_4) will capture and decode the DATA packet from the direct link. If the DATA packet is correctly decoded² and the relay selection criterion is satisfied, the relay candidate will contend to forward their packet to destination when necessary.

If the initial transmission succeeds, the message procedure will proceed exactly in the same way as the original DCF scheme. Otherwise the scheme will move to the cooperative retransmission phase.

B. Cooperative Retransmission Phase

If the direct transmission fails, the cooperative retransmission phase will be initiated automatically after ACK timeout. The DATA packet is forwarded to the destination at the same data rate. The message sequences for the cooperative retransmission are illustrated in Fig. 4.

In this phase, the relay candidates that have received the data packet correctly and satisfy the relay selection criterion

²The error-check can be performed by means of a cyclic redundancy check (CRC).

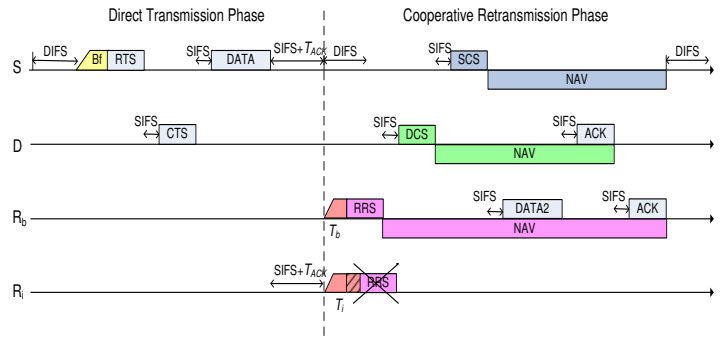

Fig. 4. Phase II: Cooperative Retransmission.

will backoff a specified period of time before they transmit packets to the destination node. The backoff time before the transmission at each relay node is determined based on the instantaneous relay channel condition. The optimal relay node R_b is guaranteed to have the shortest backoff time T_b and therefore to be the first one to transmit. The relay selection scheme will be explained in details in a separate subsection in the following.

An additional three-way handshaking is introduced before data retransmission to protect message sequences against collisions during the cooperative phase. As shown in Fig. 4, the handshaking starts with the Relay Ready to Send (RRS) frame sent by the active relay node, responded by the Destination Clear for relay to Send (DCS) frame from the destination node and the Source Clear for relay to Send (SCS) frame from the original source node.

The three introduced control frames work similarly to RTS/CTS frames in the direct transmission phase, carrying the time information about the ongoing cooperative retransmission attempt. As we can see from Fig. 4, the NAV value from the RRS frame is set to be sum of 5 SIFS intervals, the DCS transmission time, the SCS transmission time, the DATA transmission time and double ACK transmission time; the NAV value from the DCS frame is set to be the NAV value from received RRS frame minus a SIFS interval and the DCS transmission time; and the NAV value from the SCS frame is set to be the NAV value from received RRS frame minus 2 SIFS intervals, the DCS transmission time and the SCS transmission time.

The RRS frame has the same format with the RTS frame in the original DCF protocol and the DCS and SCS frames have the same format with the CTS frame. The new control frames are also transmitted at the same rate with the original RTS and CTS frames.

Through the cooperative three-way handshaking, others nodes in the sensing ranges of R, S and D are prevented to get channel access during the cooperative retransmission phase. The protected area in the cooperative retransmission phase is illustrated in Fig. 5, where R_2 is selected to be the optimal relay node R_b as an example.

After the handshaking, the selected relay node R_b will forward its received packet to the destination, as shown in Fig. 4. If D decodes the packet correctly after the cooperative

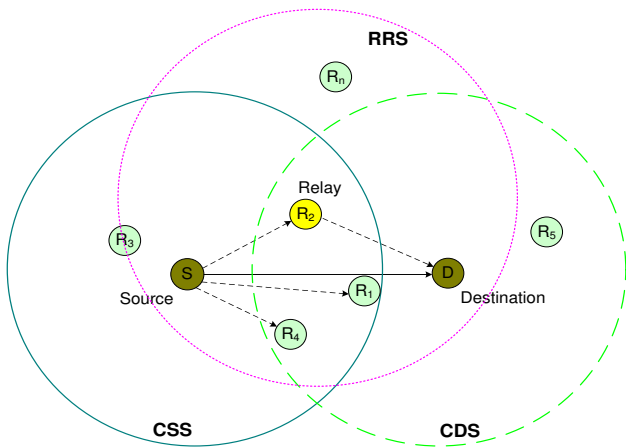

Fig. 5. Cooperative Three-way Handshaking.

retransmission, it will return an ACK packet, which is relayed afterwards by R_b to S. Two-step ACK is designed in our scheme in order to guarantee a reliable transmission because when the direct transmission from S to D is not successful, it is likely that the ACK frame would also fail to reach S if it is sent directly to S on the same channel.

Otherwise, if the cooperative retransmission fails because of corruption on the transmission channel, no ACK packet will be returned from the destination. In this case, the source node will sense the channel for DIFS for another round of packet transmission after the two-step ACK timeout.

C. Relay Selection

In our scheme, only nodes that can hear both the source and the destination node and have decoded the packet received from S correctly have an opportunity to participate in the cooperation. In such context, only channel conditions from relays to destination will be considered to choose the optimal relay for reliable cooperative retransmission. Therefore, the channel between each qualified relay candidate and the destination needs to be measured and the candidate with the best relay channel condition will be selected to retransmit first.

The relay channel condition in our scheme is represented by the measured SNR value of the CTS packet received from the destination node, exploiting the reciprocity of the physical channel in the wireless local area network.

After the cooperative phase starts, each relay candidate that has decoded its received data packet correctly starts its timer with the initial value of:

$$T_i = \left\lceil \text{DIFS} \frac{SNR_{low}}{SNR_i} \right\rceil, i = 1, 2 \dots n \quad (1)$$

where T_i is the backoff time at node R_i defined as an integer number of microseconds; SNR_i is the SNR value in dB of the received packet from D measured at R_i and SNR_{low} is the threshold of SNR_i for R_i to participate in the cooperative retransmission. If SNR_i is lower than SNR_{low} , the relay channel quality is regarded to be too poor for R_i to retransmit the packet correctly. The value of SNR_{low} can be determined

according to the specified available Modulation and Coding Schemes (MCSs) at the physical layer. DIFS is expressed as an integer value in units of microsecond.

The granularity of T_i could in principle be configured flexibly. The smaller the granularity is, the lower the theoretical probability of collisions among relays will be. However, for convenience and with regard to practical implementation aspects, a microsecond granularity has been adopted here.

According to Eq. (1), the relay node with the highest received signal strength R_b will have the shortest backoff time T_b :

$$SNR_b = \max\{SNR_i\} \Rightarrow T_b = \min\{T_i\}, \quad i = 1, 2 \dots n \quad (2)$$

In this way, the optimal relay node will be selected to be the first one to forward the data packet to the destination node. After the optimal relay node gets access to the channel and the forwarded packet is detected from the channel, the other relay candidates will quit the cooperation contention and discard their received packets, as shown in Fig. 4.

Furthermore, the upper bound of the backoff time for relay candidates in Eq. (1) is DIFS. This ensures privileged channel access for the relay node by preventing other contending nodes from getting access to the channel before them. If none of the relay timers expires within the DIFS duration, cooperative retransmission will not be executed since no qualified relay node is available in the network. As shown in Fig. 4, in this case, S will obtain the access to the channel again after ACK timeout for next data frame transmission, following the original DCF scheme.

If two or more relay candidates have the shortest backoff time, T_b , they will transmit their packets to the destination simultaneously. Then a collision will occur and the cooperative retransmission will fail. Thereafter, the source will sense the channel for DIFS after the collided RRS frames to initiate another round of data transmission.

IV. PERFORMANCE ANALYSIS

In this section, the performance of the original DCF scheme and the proposed cooperative scheme is analyzed in terms of saturation throughput and packet delivery rate (PDR) at the MAC layer.

In the DCF scheme, the system time can be broken down into virtual time slots with each virtual slot being the time interval between two consecutive countdowns of backoff timers by non-transmitting stations [16].

The normalized system saturation throughput, denoted by S , is defined as the successfully transmitted payload bits per time unit. According to [16], S can be calculated as follows:

$$S = \frac{E[G]}{E[D]} \quad (3)$$

where $E[G]$ is the number of payload information bits successfully transmitted in a virtual time slot, and $E[D]$ is the expected length of the virtual time slot.

The PDR is the ratio of successfully transmitted packets at the MAC layer to all the packets delivered from its upper layer. In our analysis, the packet transmission limit on the direct channel is set to be 1. That is, no data retransmission is allowed on the same channel.

A. non-cooperative DCF scheme

In order to calculate the throughput of the non-cooperative DCF RTS/CTS protocol S^d , $E[G]$ and $E[D]$ in Eq. (3) for the original scheme are denoted as $E[G]^d$ and $E[D]^d$ and expressed in the following:

$$E[G]^d = (1 - p_e)L, \quad (4)$$

$$E[D]^d = E[\delta] + T_{DATA} + T_{RTS} + T_{CTS} + T_{ACK} + 3SIFS + DIFS. \quad (5)$$

where p_e is the packet error rate on the direct channel from source to destination and L is the payload length in bits. T_{DATA} , T_{RTS} , T_{CTS} and T_{ACK} represent the time used for transmitting the DATA frame, the RTS frame, the CTS frame and the ACK frame respectively. δ is the backoff time before the transmission, which is a uniformly distributed random value between 0 and the current contention window size, which is the minimal contention window size in our case, multiplied by slot time.

The PDR of the original DCF scheme is the packet successful rate on the direct link.

$$PDR^d = 1 - p_e. \quad (6)$$

B. Cooperative retransmission scheme

Three cases are discussed for performance analysis of the proposed cooperative scheme: 1) direct transmission succeeds; 2) direct transmission fails but collisions happens to the RRS frames when multiple relay candidates are contending for the channel access; 3) cooperative retransmission is executed through the optimal relay node.

$E[G]^c$ and $E[D]^c$ for calculation of the saturation throughput S^c in the cooperative scheme according to Eq. (3) are expressed as follows.

$$E[G]^c = (1 - p_e)L + p_e(1 - p_c)(1 - p_e^*)L; \quad (7)$$

$$E[D]^c = (1 - p_e)E[D_1] + p_e p_c E[D_2] + p_e(1 - p_c)E[D_3]; \quad (8)$$

where p_c is the collision probability when more than one relay nodes have the shortest backoff time and start to transmit at the same time; p_e^* is the packet error rate on the retransmission channel from the optimal relay node to the destination node; L is the payload length in bits.

The successfully delivered payload in Eq. (7) is the sum of those successfully bits in the aforementioned cases 1) and 3). No information is delivered successfully in case 2). $E[D_1]$, $E[D_2]$ and $E[D_3]$ in Eq. (8) are the corresponding expected

length of the virtual time slot in the aforementioned cases 1), 2) and 3) respectively, and are expressed as follows.

$$E[D_1] = E[\delta] + T_{DATA} + T_{RTS} + T_{CTS} + T_{ACK} + 3SIFS + DIFS; \quad (9)$$

$$E[D_2] = E[D_1] + T_b + T_{RRS}; \quad (10)$$

$$E[D_3] = E[\delta] + 2T_{DATA} + T_{RTS} + T_{CTS} + T_{RRS} + T_{DCS} + T_{SCS} + 3T_{ACK} + 8SIFS + DIFS + T_b. \quad (11)$$

In the above equations, T_{RRS} , T_{DCS} and T_{SCS} represent the time used for transmitting the RRS frame, the DCS frame and the SCS frame, and T_b is the backoff time consumed at the selected optimal relay node.

The PDR of the cooperative scheme is the sum of the packet successful rate on the direct channel and the additional successful probability on the cooperative retransmission channel.

$$PDR^c = 1 - p_e + p_e(1 - p_c)(1 - p_e^*). \quad (12)$$

V. SIMULATION RESULTS

The simulation results based on Matlab implementation of the original DCF protocol and the proposed cooperative retransmission protocol are presented and analyzed in this section.

In our simulations, the relay nodes are uniformly distributed in a square area of 50 m×50 m. The performance presented in this section is averaged 1000 different randomly generated topologies of the relay nodes. The source node and the destination node are placed symmetrically along the center line and 25 m apart from each other.

The channels of each transmission pair, i.e. from source node to destination, from source to relay and from relay node to destination, are independent Rayleigh fading channels.

A free space path loss model [17] is adopted with the transmitting and receiving antenna gains set to be 1.

$$FSPL(dB) = 20\log_{10}(d) + 20\log_{10}(f) + 32.44. \quad (13)$$

where f is the frequency measured in units of MHz, which is 2400 in wireless local network and d is the distance measured in km.

The payload length is set to be 500 bytes. The size for the RTS and RRS frames is set to be 20 bytes and the size of the CTS, DCS and SCS frames is 14 bytes. The length of the MPDU header is 24 bytes. The ACK packet is 14 bytes long. The overhead of the physical layer header is 20 μ s. The physical layer data rate is set to be 13 Mbps (QPSK with convolutional code rate 1/2) and the basic rate is 6 Mbps. All the other parameters in this section are configured according to the 802.11g standard unless otherwise stated.

Several parameters such as channel conditions, relay density in the network and the SNR threshold for the relay selection scheme have been investigated in order to evaluate the performance of the proposed cooperative protocol. E_t/N_0 is used to describe channel quality in our simulation environments,

where E_t is the transmitted energy per bit at the transmitter and N_0 is the spectral power density of the Gaussian white noise at the receiver.

A. Performance with different relay density

In order to investigate the influence of different relay densities on the protocol performance, 5, 20 and 100 relay nodes are randomly uniformly distributed in the network for simulations, respectively. The threshold SNR for the relay selection is set to be 2.0 dB corresponding to a target PER of 0.98 for 500-byte packet length and QPSK with convolutional code rate 1/2 MCS scheme. Following the scheme described in Sec. III, a single optimal relay is selected among all the relay candidates in the network according to the relay channel conditions.

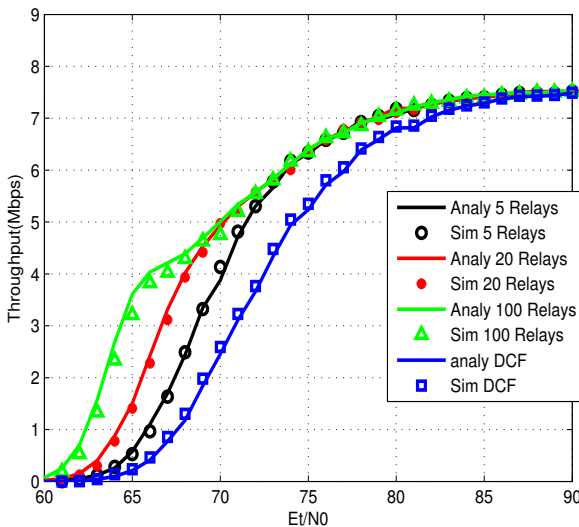

Fig. 6. Throughput Performance Comparison.

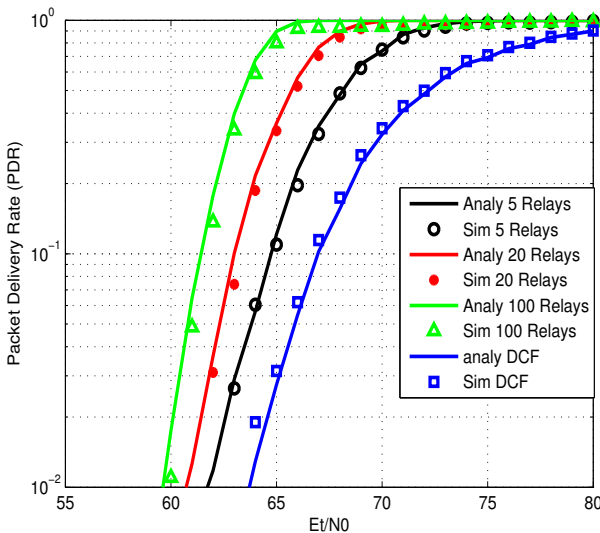

Fig. 7. Packet Delivery Rate Comparison.

Fig. 6 shows the throughput performance of the proposed cooperative scheme compared with the original DCF non-cooperative scheme under different channel conditions. The

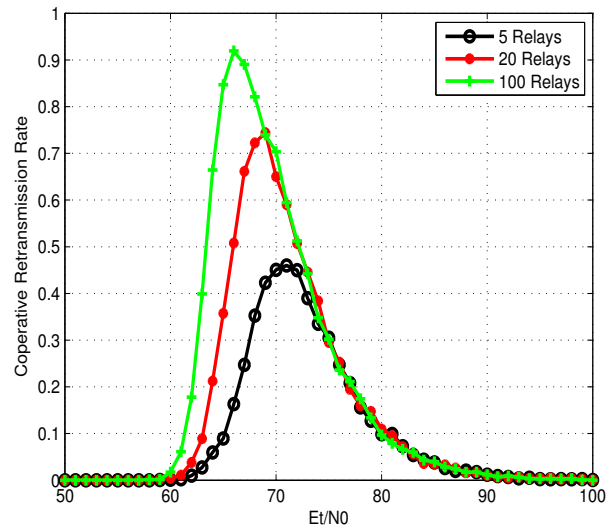

Fig. 8. Average Cooperation Rate Comparison.

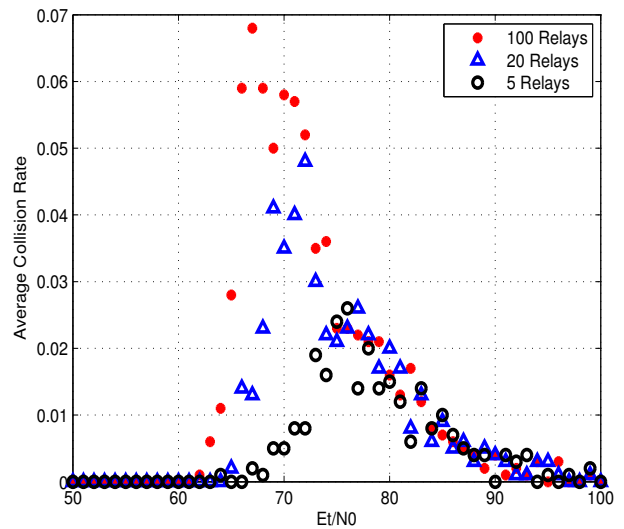

Fig. 9. Average Collision Rate Comparison.

simulation results coincide with the theoretical analysis perfectly. We can see that significant improvement has been achieved by the novel cooperative scheme, especially when the channel is in poor condition (60~80 dB in the E_t/N_0 field), where the cooperative retransmission is needed. The benefits come from not only the reduction of the time needed for data retransmission in the cooperative scheme but also from the generally better relay channel condition compared with the direct link condition. The improvement becomes more significant as the network gets denser because the probability to find a good retransmission channel gets higher when there are more active relays in the network.

Fig. 7 shows the packet delivery rate performance comparison of the proposed cooperative scheme and the original DCF scheme. Both the analytical and simulation results show that the packet delivery rate is enhanced by the cooperative scheme and a great improvement is observed when there are more potential relay nodes in the network. That is because

the selected optimal relay channel provides higher reliability than the direct channel and the reliability gets higher when the relay nodes are more densely distributed. Therefore, the cooperative retransmission becomes more efficient.

The cooperative retransmission rate averaged among all the simulated cooperative data transmissions is shown in Fig. 8. It can be observed that the cooperative retransmissions happens mainly between 60 dB and 80 dB in the E_t/N_0 field, where the relay channel has better condition than the direct channel. On one hand, when the channel condition is too poor, i.e. E_t/N_0 is lower than 60 dB, there is no relay node in the network qualified to retransmit the data packet. On the other hand, when E_t/N_0 is higher than 80 dB, the direct channel itself is reliable enough and no retransmission is needed. We can also see that more retransmissions are executed when the relay nodes are more densely distributed. The reason is still the probability to have a reliable relay channel is higher when there are more distributed relay candidates to choose from in the given area.

The collision rate averaged among all the simulated cooperative data transmissions is illustrated in Fig. 9. We can see that the collision problem, which is a big challenge in a relay selection scheme, is effectively solved in the proposed cooperative protocol, by sorting contending relay candidates according to the relay channel condition. By contrast with Fig. 8, collisions happen where cooperative retransmission is executed, and the peak collision rate occurs at the time of highest cooperative retransmission rate. When the network is sparsely distributed, collision probability is very low (below 0.03 when number of relay nodes is 5). As the network density increases, the number of collisions increases but still remains small. We can see from Fig. 9 that even in a dense network with 100 potential relay nodes, the highest collision rate is below 0.07.

B. Performance with relay selection threshold

As shown in Eq. (1), in our cooperative scheme, a SNR threshold value for the received CTS packet, SNR_{low} , needs to be determined for the relay selection, according to the MCS scheme adopted at the physical layer. The threshold value not only determines whether a relay node is qualified to cooperate but also influences the distribution of the backoff time at all relay candidates and therefore affects the collision probability.

Fig. 10 and Fig. 11 illustrate the throughput and the PDR performance with different SNR_{low} values respectively, in which the optimal relay is selected from 20 randomly uniformly distributed candidates in the network.

We can see that the proposed protocol provides highest throughput and PDR when SNR_{low} is 2.0 dB, which is therefore recommended as the threshold value for the given 500 bytes payload length and QPSK 1/2 scheme. It could also be observed that the performance shows slight differences when SNR_{low} is among 2.0 dB, 3.2 dB and 4.0 dB, corresponding to a target PER of 0.98, 0.1 and 0.01 respectively. This indicates that the cooperative protocol is tolerant of the inaccuracy of the SNR_{low} value in the given network.

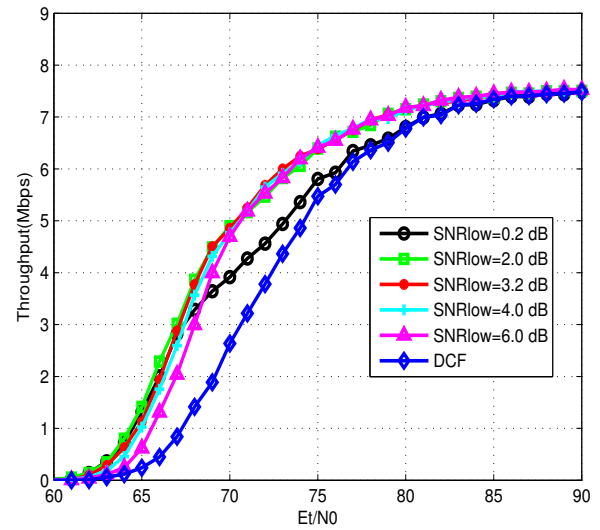

Fig. 10. Throughput Performance Comparison.

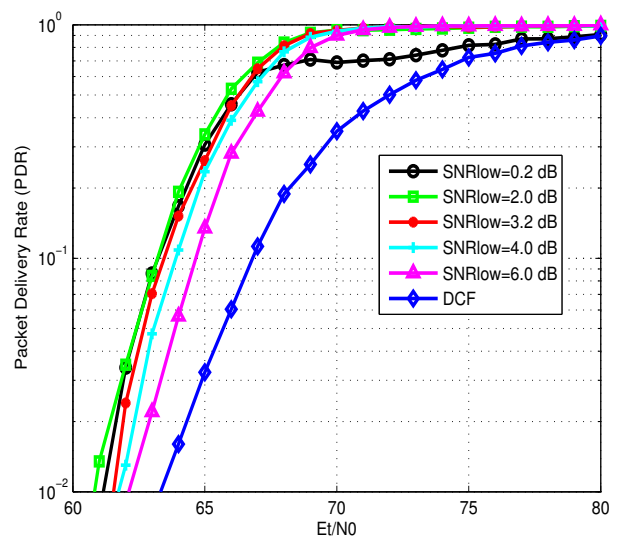

Fig. 11. Packet Delivery Rate Comparison.

However, when SNR_{low} is too small (0.2 dB), the SNR resolution drops significantly in the backoff time according to Eq. (1), which means more SNR values result in the same backoff time. Therefore, the collision probability is increased and the protocol performance declines consequently. In the E_t/N_0 field between 60 dB and 75 dB, where numerous collisions are observed, the throughput of the cooperative protocol is even lower than the original DCF protocol, as shown in Fig. 10 .

On the other hand, when the relay selection criterion is harsh (SNR_{low} is 6.0 dB), fewer relay candidates are allowed to participate. The probability to have a relay node for retransmission is decreased, especially in poor channel condition. Hence less throughput and lower PDR are resulted in the E_t/N_0 field between 60 dB and 70 dB.

The cooperative retransmission rate and the collision rate averaged among the simulated cooperative data transmissions are demonstrated in Fig. 12 and Fig. 13 respectively. It can be

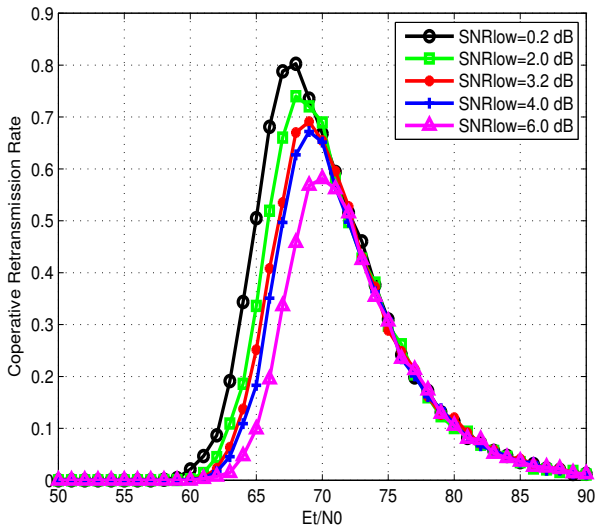

Fig. 12. Average Cooperation Rate Comparison.

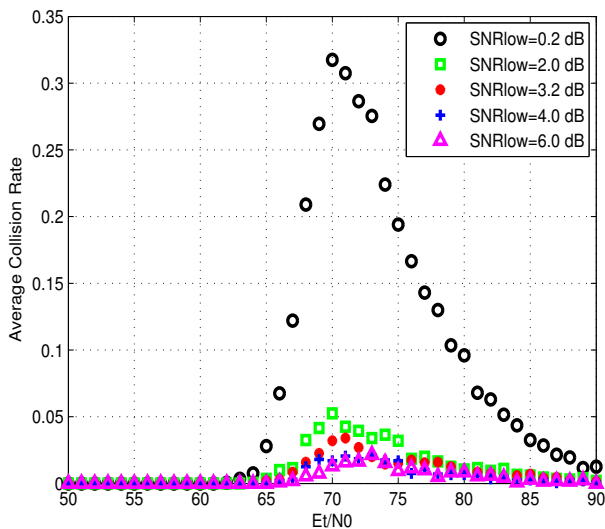

Fig. 13. Average Collision Rate Comparison.

observed that more cooperative retransmissions are executed when the threshold value SNR_{low} is lower, and accordingly the collision rate is increased. When SNR_{low} is as low as 0.2 dB, the collision rate rises significantly, which consequently drops the throughput and PDR performance noticeably, as shown in Fig. 10 and Fig. 11.

Additional simulations have been made to investigate the performance of the proposed cooperative scheme with different payload length and different MCS schemes. These results, even though not presented in this paper, have illustrated that significant performance enhancement is obtained by the proposed scheme in all the investigated scenarios.

VI. CONCLUSIONS

In this paper, we have proposed a cooperative RTS/CTS retransmission MAC protocol, which includes a distributed relay selection scheme and an additional cooperation protection scheme.

Simulation results show that the proposed cooperative protocol outperforms the original DCF scheme in both throughput and packet delivery rate performance when the channel condition is poor and data retransmission is needed. The improvement becomes more evident as the network gets denser. The collisions probability has been effectively reduced by sorting relay nodes according to their instantaneous relay channel conditions. Even in a dense network with 100 potential relay nodes, the highest collision rate is below 0.07. In addition, the SNR threshold value for the relay selection scheme is recommended to be 2.0 dB, corresponding to a target PER of 0.98 in the given network. It is also shown in the simulation results that the performance of the proposed cooperative protocol is robust against the inaccuracy of the SNR threshold value.

REFERENCES

- [1] J. N. Laneman, D. N. C. Tse and G. W. Wornell, "Cooperative diversity in wireless networks: efficient protocols and outage behavior", IEEE Trans. Inform. Theory, Vol. 50, No. 12, pp.3062-3080, Dec. 2004.
- [2] A. Sendonaris, E. Erkip and B. Aazhang, "User cooperation diversity-Part I: system description", IEEE Trans. Comm., Vol. 51, No. 11, pp. 1927-1938, Nov. 2003.
- [3] A. Sendonaris, E. Erkip and B. Aazhang, "User cooperation diversity-Part II: implementation aspects and performance analysis", IEEE Trans. Comm., Vol. 51, No. 11, pp. 1939-1948, Nov. 2003.
- [4] S. Moh, C. Yu, S. Park and H. Kim, "CD-MAC: Cooperative diversity MAC for robust communication in wireless ad hoc networks", in Proc. of IEEE ICC, Glasgow, UK, June 2007.
- [5] J. S. Pathmasuritharam, A. Das, and A. K. Gupta, "Efficient multi-rate relaying (EMR) MAC protocol for Ad Hoc networks", in Proc. of IEEE ICC 2005, Singapore, May 2005.
- [6] A. K. Sadek, W. Su and K. J. Liu, "Clustered cooperative communications in wireless networks", in Proc. of IEEE GLOBECOM, Atlanta, GA, USA, Nov. 2005.
- [7] M. Dianati, X. Ling, K. Naik and X. Shen, "A node-cooperative ARQ scheme for wireless ad hoc networks", IEEE Trans. Comm., Vol. 55, No. 3, pp. 1032-1044, May 2006.
- [8] P. Liu, Z. Tao, S. Narayanan, T. Korakis and S. Panwar, "CoopMAC: A cooperative MAC for wireless LANs", IEEE JSAC, Vol. 25, No. 2, pp. 340-354, Feb. 2007.
- [9] J. Alonso-Zarate, E. Kartsakli, Ch. Verikoukis, and L. Alonso, "Persistent RCSMA: A MAC protocol for a distributed cooperative ARQ scheme in wireless networks", EURASIP Journal on Advances in Signal Processing, Vol. 2008, Article ID 817401, 13pages.
- [10] IEEE 802 WG, "Wireless LAN medium access control (MAC) and physical layer (PHY) specifications" IEEE 802.11, 1999.
- [11] C. Chou, J. Yang and D. Wang, "Cooperative MAC protocol with automatic relay selection in distributed wireless networks", in Proc. of IEEE PerCom'07, Briarcliff Manor, NY, USA, March. 2007.
- [12] H. Shan, P. Wang, W. Zhuang and Z. Wang, "Cross-layer cooperative triple busy tone multiple access for wireless networks", in Proc. of IEEE GLOBECOM, New Orleans, LA, USA, Nov. 2008.
- [13] Y. Zhao, R. Adve and T. J. Lim, "Improving amplify-and-forward relay networks: optimal power allocation versus selection", IEEE Trans. Comm., Vol. 6, No. 8, pp. 3114-3123, Aug. 2007.
- [14] A. Bletsas, A. Khisti, D. P. Reed and A. Lippman, "A simple cooperative diversity method based on network path selection", IEEE JSAC, Vol. 24, pp. 695-672, March 2006.
- [15] A. K. Sadek, W. Yu and K. J. R. Liu, "When does cooperation have better performance in sensor networks?", in Proc. of IEEE SECON, Reston, VA, USA, Sept. 2006.
- [16] G. Bianchi, "Performance analysis of the IEEE 802.11 distributed coordination function", IEEE JSAC, Vol. 18, No. 3, pp. 535-547, March 2000.
- [17] C. A. Balanis, "Antenna Theory", John Wiley and Sons Inc., 2003.